

puk













Collection Book
2026









puk

OUTDOOR
ARCHITECTURAL
LIGHTING

Floodlights

								
101600 Qubo .16	101100 Flash .24	109000 Book .28	101700 Flamingo .30	102100 Coiny .34	101200 City Wall .36	101500 Zeus .38	101400 Ring .44	101900 Nanospot .54
								
102200 Nanospot Steel .60								















In-ground

								
207000 Terra .68	201000 Hydrofloor .84	206000 Hydrofloor Invisa .102	205000 Hydrofloor Vetro .106	208000 Face-Up .108	209000 Hydrofloor Nano Linear .112	204000 Line Vetro .118	201100 Lineaground .122	201200 Lineaground Trimless .138

Underwater

			
301000 Scuba .152	303000 Pool .156	305000 Dive .160	306000 Hydroflex Underwater .162

Wall Mounting

								
401100 Wave .168	402600 Tech Evo .170	403100 Nanowall .174	401000 Tech .190	403200 Wallbox .196	402500 Tag .202	402800 Frame .206	401700 Eclipse .210	401600 Surf .216
								
402100 Hydrocove .222	401800 Hydroflex .224	402900 Hydroflex Optics .230	403300 Lineafacade .232	402400 Horizon .244	406000 Target .248			

Wall-recessed



505000
Nanostep
.252



506000
Passoluce
.256



504000
Surf Recess
.266



503000
Line Step
.268

Bollards



601800
Boulevard
Mini
.272



609000
Boulevard
.274



601700
Sector
.278



601500
Promenade
.282



601900
Scout
.286



602300
Coiny
Bollard
.288



602100
Tron
.292



601600
Periscope
.294



602200
Alder
.298

Downlight



709000
Nano
Downlight
.304



701400
Nano Linear
Downlight
.308



708000
Tag O3
.312



701300
Cielo
.314



701100
Qubo
Downlight
.322



701200
Cylinder
.328



701500
Lineacelling
.334

Urban Lights



809000
Plaza
.350



802000
City
.354



806000
Zeus Pole
.358



803000
Book Pole
Top
.362



807000
Ring Pole
.364



808000
Qubo Pole
.376



805000
Flash Pole
.380

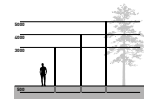

809900
Poles &
Accessories
.388

Décor



902000
Vetra
Sphera
.394



903000
Vetra
Filis
.400



904000
Vetra
Dot
.404



905000
Flexa
Sphera
.408



906000
Flexa
Filis
.412



907000
Flexa
Dot
.414



908000
Rondis
.416



















909000
Lucea
.422

5 Year warranty

Outdoor lighting is by definition one of the most challenging and competitive sectors and demands the highest quality products and services: innovative solutions, technical excellence, design flexibility and consistent performance. That is why here at P.U.K. we are open to constant technological upgrades (from miniaturisation to LEDs) and we strive to improve the quality and reliability of our range.

We produce one of the most complete and competitive world-class collections available on the international market, offering a five-year full warranty on LED products.

HOW TO READ THE CATALOGUE

	NEW PRODUCTS
	EUROPEAN CONFORMITY
	5 YEARS WARRANTY
	CLASS I
	CLASS II
	CLASS III
	IK CODE SHOCK RESISTANCE
	IP CODE PROTECTIVE DEGREE
	1-10 V DIMMABLE
	DALI DIMMABLE
	STATIC LOAD CAPACITY
	TOOLS-FREE
	RGB LIGHT
	FULL RGB LIGHT
	ADJUSTABLE
	DMX-512

123456 . 22 . 04 . 01 . 1 . EL

Article

Light Source

Beam Angle

Finish

Dimming

Accessory











Light Source

.00	No CCT
.22	2200°K
.24	2400°K
.27	2700°K
.30	3000°K
.35	3500°K
.40	4000°K
.50	5000°K
.60	6000°K
.65	6500°K
.RB	RGB
.RW	RGBW
.TW	Tunable White
.AM	Amber
.BL	Blue
.RE	Red
.GR	Green
.ZZ	Customization

Beam angle

.00	No Beam Angle
.04	4°
.08	8°
.10	10°
.11	11°
.12	12°
.14	14°
.15	15°
.18	18°
.20	20°
.25	25°
.28	28°
.30	30°
.32	32°
.35	35°
.36	36°
.40	40°
.45	45°
.55	55°
.60	60°
.90	90°
.AB	Asymmetric Backbard
.AF	Asymmetric Forward
.AL	360°
.AS	Generic Asymmetric
.BL	Blade Optic
.CP	Cycle-Route Pedestrian
.DF	Diffused
.E1	Elliptical 45x10
.E2	Elliptical 15x30
.E3	Elliptical 30x60
.E4	Elliptical 8x35
.E5	Elliptical 10x40
.E6	Elliptical 10x60
.FW	Floor Washer
.HA	180°
.HB	90°+90°
.HE	270°
.RT	Rotosymmetrical
.ST	Street
.SY	Generic Symmetric
.WW	Wall Wahser
.SW	Symmetric Wide
.ZZ	Customization

Finish

.00	No Finish
.01	 Ral9006
.02	 Ral7016
.03	 Ral9005 Black
.04	 Ral 9016 White
.05	Powder Coating In Special Color Finish
.06	Special Color Finish
.07	 Obsidian Black
.08	 Wild Green
.09	 Dark Brown
.GL	 Clear Glass
.OP	 Opal/Milky/Resin/Transparent
.SS	 Stainless Steel

Dimming

.0	ON/OFF
.1	1-10V O 0-10V
.2	Phase Cut - Triac
.D	Dali, Dali2 , Etc.
.X	DMX
.Z	Customization

Accessory / Optional

.00	No Accessory
.EL	Elliptical Glass
.EM	Emergency
.GS	Glare Shield
.HC	Honeycomb
.HE	Elliptical + Honeycomb
.HP	Honeycomb + Pole Plate
.HR	Honeycomb + Prismatic
.ND	No Driver
.PE	Pole Plate + Elliptical
.PP	Pole Plate
.PR	Pole Plate + Prismatic
.PS	Prismatic Glass
.SC	Super Comfort Glare Shield
.TB	Tree Branch
.TH	Tree Branch + Honeycomb
.TE	Tree Branch + Elliptical
.TP	Tree Branch + Prismatic
.ML	Microlouvre
.CD	Colored Disc
.ZZ	Customization

**Lighting
is at the
heart
of the way
we think
and build.**

Light is more.

Our lighting says everything about our quality. Lighting is at the heart of the way we think and build. Outdoor lighting requires products and services of the highest standards: innovative solutions, technical excellence, design flexibility and consistent performance. Our products bring Italian excellence to the most futuristic architecture in the world.

Made in Italy made to the highest quality.

Our quality shines through our lighting.
A principle that has always inspired any
action taken within the company.

From the strictest selection of suppliers
to the careful selection of materials,
components and technologies,
quality lies at the heart of how we create
and manufacture our products.

Each new project becomes an opportunity
for research and development: the drive
to improve product and process standards.

Our products are entirely Made in Italy and
are checked repeatedly, from the receipt
of raw materials through to the processing,
assembly and prototype stages.

Our goal is to supply you with the very best
lighting equipment offering the latest
in technological developments.

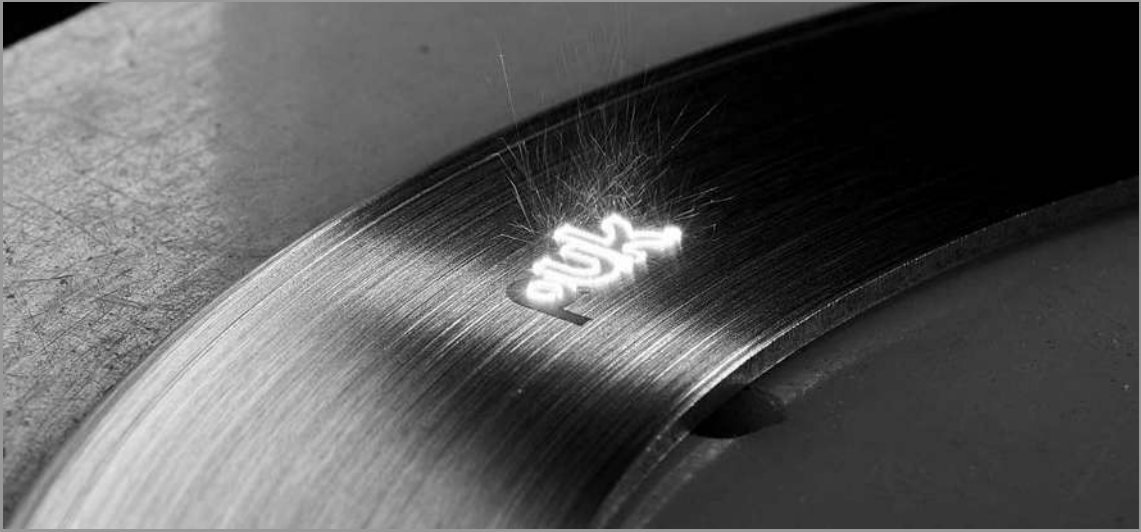

We light up the world.

We specialise in the study and creation of lighting solutions for architectural and outdoor applications. We follow each project with the greatest care and attention, offering effective collaboration to enhance all aspects, whether they may be technical, structural, expressive or related to performance. We operate all over the world and are proud to say that we have become a point of reference in the field of outdoor lighting. We are as ambitious and determined as you are and we can work with you to create something spectacular and unique.

We are ready to create the perfect light, lighting that will enhance the features and benefits of your project.



Lighting design according to PUK.

This is our consulting service that allows you to choose the most suitable lighting solution, not only on the basis of technical documentation but also thanks to the most advanced rendering systems available today.

The quality of our lighting design is the result of a technical-scientific approach that also takes into account ever-changing and unavoidable elements such as the environmental and architectural context, style and design, industry and type of business, current regulations regarding safety, the comfort of human visual perception, the psychological/communication effect to be obtained as well as the enhancement of some details.



Why choosing us

Because we have concentrated 30 years of experience, expertise and specialization in outdoor lighting in an accurate and complete lighting design and consulting service.

Our professional staff will assist you in designing efficient and reliable solutions. Analysis tools and technical methods always guarantee you will get the result you expect.

Puk lighting design consultancy is a free of charge service for our clients. Let your inner light shine with Puk.

Step by step, towards the solution

Lighting design is a complex activity which requires a rigorous and all-round consulting service: nothing must be left to chance.

The Puk team defines the criteria for drafting the lighting design. These are the phases that lead from scrupulous analysis of needs to the solution and implementation of the system:

**FEASIBILITY STUDY
PRELIMINARY PROJECT
FINAL PROJECT
EXECUTIVE PROJECT**

3D Rendering: a crystal clear vision

In Puk we attach a special importance to the quality of the graphic representation. In particular, our 3D renderings, static or with different levels of animation, are of very high quality and allow to evaluate the different project options set, with an effect almost identical to reality and having a great aesthetic impact.

This makes it easier to evaluate the different options and make a decision.



FLO
OD
LIG
HTS





Qubo

Nava + Arosio

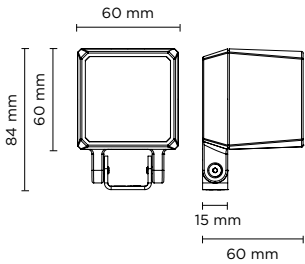

PRODUCT WEIGHT 0,70 kg



Code Example

101601.**27**.**04**.**01**.**0**

Accessories p. 23

Qubo Micro HP

Floodlight for outdoor installation on a façade/wall, with U shape fixing bracket allowing vertical adjustment of +90° / -40°. Phospho-chromatised and polyester powder coated die-cast copper-free aluminium base and head, tempered safety glass, moulded silicone gaskets, with screws in stainless steel. Remote 24V DC power supply needed, with 1 x CREE "XHP35" LED. IP66 rating.

101601

6W

CCT	Beam Angle	lm	lm/w	Finish	Dimming
.27 2700°K	.04 4°	465	77.50	.01 RAL 9006	.0 ON/OFF
	.10 10°	450	75.00	.02 RAL 7016	
	.28 28°	485	80.83	.03 RAL 9005	
	.55 55°	383	63.83		
.30 3000°K	.04 4°	510	85.00		
	.10 10°	489	81.50		
	.28 28°	474	79.00		
	.55 55°	403	67.15		
.40 4000°K	.04 4°	520	86.67		
	.10 10°	499	83.17		
	.28 28°	484	80.67		
	.55 55°	411	68.57		

Remote Driver Selection

Brand	Manufacturer code	Type	Watt	IP Rate	Number of fixtures
Meanwell	LPV-20-24	constant voltage 24V DC	20W	IP67	min 1 - max 3
Meanwell	LPV-35-24	constant voltage 24V DC	35W	IP67	min 1 - max 5
Meanwell	LPV-60-24	constant voltage 24V DC	60W	IP67	min 1 - max 9

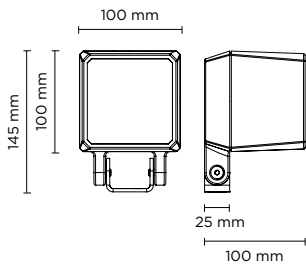

PRODUCT WEIGHT 1,30 kg



Code Example

101602.27.14.01.0

Accessories p. 23

Qubo Mini COB

Floodlight for outdoor installation on a façade/wall, with U shape fixing bracket allowing vertical adjustment of +90° / -40°. Phospho-chromatised and polyester powder coated die-cast copper-free aluminium base and head, tempered safety glass, moulded silicone gaskets, with screws in stainless steel. Built-in LED driver, with 1 COB CREE "CXB 1310" LED. IP66 rating.

101602

10W

CCT	Beam Angle	lm	lm/w	Finish	Dimming
.27 2700°K	.14 14°	1045	104.5	.01 RAL 9006	.0 ON/OFF
	.35 35°	1007	100.7	.02 RAL 7016	.D DALI
	.55 55°	950	95	.03 RAL 9005	
.30 3000°K	.14 14°	1.100	110		
	.35 35°	1.060	106		
	.55 55°	1.000	100		
.40 4000°K	.14 14°	1.200	120		
	.35 35°	1.140	114		
	.55 55°	1.083	108		

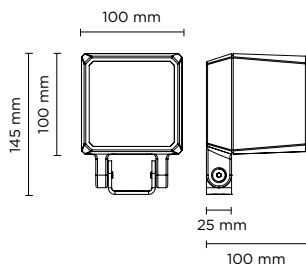

PRODUCT WEIGHT 1,30 kg



Code Example

101605.27.04.01.0

Accessories p. 23

Qubo Mini HP

Floodlight for outdoor installation on a façade/wall, with U shape fixing bracket allowing vertical adjustment of +90° / -40°. Phospho-chromatised and polyester powder coated die-cast copper-free aluminium base and head, tempered safety glass, moulded silicone gaskets, with screws in stainless steel. Built-in LED driver, with 1 x CREE "XHP35" LED. IP66 rating.

101605

8W

CCT	Beam Angle	lm	lm/w	Finish	Dimming
.27 2700°K	.04 4°	629	78.62	.01 RAL 9006	.0 ON/OFF
	.10 10°	610	76.25	.02 RAL 7016	.D DALI
	.28 28°	656	82.00	.03 RAL 9005	
	.55 55°	519	64.88		
.30 3000°K	.04 4°	690	86.25		
	.10 10°	662	82.75		
	.28 28°	642	80.25		
	.55 55°	546	68.21		
.40 4000°K	.04 4°	703	87.88		
	.10 10°	676	84.50		
	.28 28°	656	82.00		
	.55 55°	558	69.70		



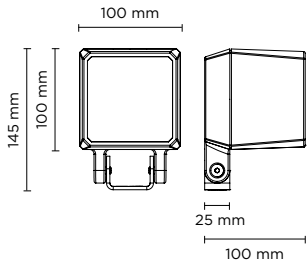

PRODUCT WEIGHT 1,30 kg



Code Example

101605 .RW .12 .01 .X

Accessories p. 23

Qubo Mini DMX RGBW

Floodlight for outdoor installation on a façade/wall, with U shape fixing bracket allowing vertical adjustment of +90° / -40°. Phospho-chromatised and polyester powder coated die-cast copper-free aluminium base and head, tempered safety glass, moulded silicone gaskets, with screws in stainless steel. Remote 24V DC power supply needed, DMX driver integrated; with 1 x CREE "XML" RGBW LED. IP66 rating.

101605

4,5W

CCT	Beam Angle	lm	lm/w	Finish	Dimming
.RW RGBW	.12 12°	160	35.55	.01 RAL 9006	.X DMX
	.25 25°	152	33.78	.02 RAL 7016	
	.35 35°	145	32.23	.03 RAL 9005	

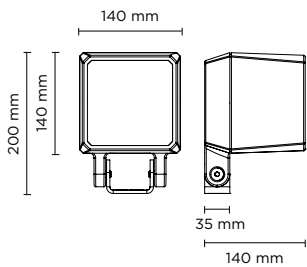

PRODUCT WEIGHT 3,10 kg



Code Example

101603 .27 .14 .01 .0

Accessories p. 23

Qubo Medium COB

Floodlight for outdoor installation on a façade/wall, with U shape fixing bracket allowing vertical adjustment of +90° / -40°. Phospho-chromatised and polyester powder coated die-cast copper-free aluminium base and head, tempered safety glass, moulded silicone gaskets, with screws in stainless steel. Built-in LED driver, with 1 COB CREE "CXB 1512" LED. IP66 rating.

101603

16W

CCT	Beam Angle	lm	lm/w	Finish	Dimming
.27 2700°K	.14 14°	1805	112.81	.01 RAL 9006	.0 ON/OFF
	.35 35°	1722	107.62	.02 RAL 7016	.1 1-10 V
	.55 55°	1636	102.25	.03 RAL 9005	.D DALI
.30 3000°K	.14 14°	1.900	118.75		
	.35 35°	1.813	113.31		
	.55 55°	1.722	107.62		
.40 4000°K	.14 14°	2.000	125.00		
	.35 35°	1.900	118.75		
	.55 55°	1.805	112.81		

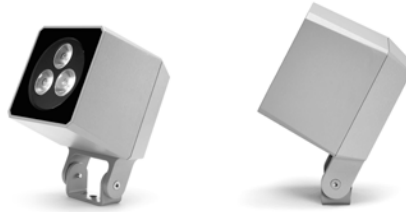
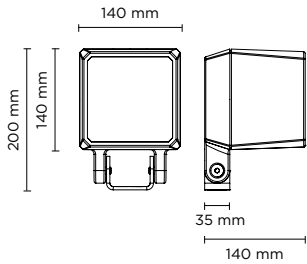

PRODUCT WEIGHT 3,10 kg



Code Example

101606.27.04.01.0

Accessories p. 23

Qubo Medium HP

Floodlight for outdoor installation on a façade/wall, with U shape fixing bracket allowing vertical adjustment of +90° / -40°. Phospho-chromatised and polyester powder coated die-cast copper-free aluminium base and head, tempered safety glass, moulded silicone gaskets, with screws in stainless steel. Built-in LED driver, with 3 x CREE "XHP35" LED. IP66 rating.

101606

20W

CCT	Beam Angle	lm	lm/w	Finish	Dimming
.27 2700°K	.04 4°	1900	95.00	.01 RAL 9006	.0 ON/OFF
	.10 10°	1853	92.65	.02 RAL 7016	.1 1-10 V
	.28 28°	1948	97.4	.03 RAL 9005	.D DALI
	.55 55°	1575	78.75		
.30 3000°K	.04 4°	2.050	102.50		
	.10 10°	2.000	100.00		
	.28 28°	1.950	97.50		
	.55 55°	1.658	82.88		
.40 4000°K	.04 4°	2.100	105.00		
	.10 10°	2.050	102.50		
	.28 28°	2.000	100.00		
	.55 55°	1.700	85.00		

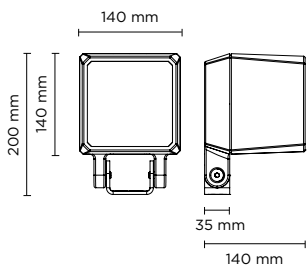

PRODUCT WEIGHT 3,10 kg

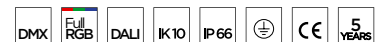

Code Example

101606.RW.12.01.D

Accessories p. 23

Qubo Medium DMX RGBW

Floodlight for outdoor installation on a façade/wall, with U shape fixing bracket allowing vertical adjustment of +90° / -40°. Phospho-chromatised and polyester powder coated die-cast copper-free aluminium base and head, tempered safety glass, moulded silicone gaskets, with screws in stainless steel. Built-in LED driver, DMX driver integrated; with 3 x CREE "XML" RGBW LED. IP66 rating.

101606

14W

CCT	Beam Angle	lm	lm/w	Finish	Dimming
.RW RGBW	.12 12°	480	34.28	.01 RAL 9006	.D DALI
	.25 25°	468	33.43	.02 RAL 7016	.X DMX
	.35 35°	457	32.65	.03 RAL 9005	

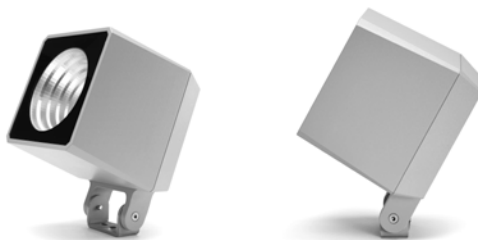
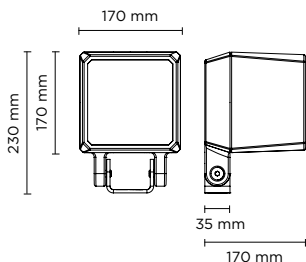

PRODUCT WEIGHT 4,50 kg



Code Example

101604.27.14.01.0

Accessories p. 23

Qubo Maxi COB

Floodlight for outdoor installation on a façade/wall, with U shape fixing bracket allowing vertical adjustment of +90° / -40°. Phospho-chromatised and polyester powder coated die-cast copper-free aluminium base and head, tempered safety glass, moulded silicone gaskets, with screws in stainless steel. Built-in LED driver, with 1 COB CREE "CXB 2540" LED. IP66 rating.

101604

42W

CCT	Beam Angle	lm	lm/w	Finish	Dimming
.27 2700°K	.14 14°	4703	111.98	.01 RAL 9006	.0 ON/OFF
	.35 35°	4514	107.48	.02 RAL 7016	.1 1-10 V
	.55 55°	4332	103.14	.03 RAL 9005	.D DALI
.30 3000°K	.14 14°	4.950	117.85		
	.35 35°	4.752	113.14		
	.55 55°	4.560	108.57		
.40 4000°K	.14 14°	5.265	125.36		
	.35 35°	5.000	119.05		
	.55 55°	4.770	113.57		

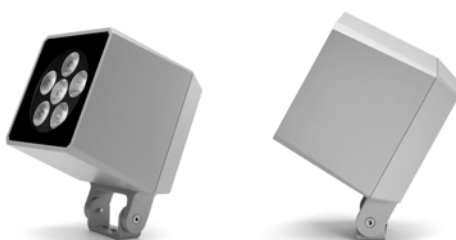
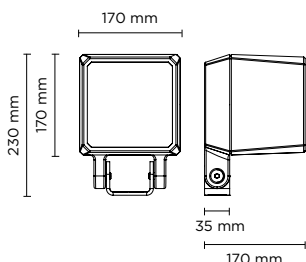

PRODUCT WEIGHT 4,50 kg



Code Example

101607.27.04.01.0

Accessories p. 23

Qubo Maxi HP

Floodlight for outdoor installation on a façade/wall, with U shape fixing bracket allowing vertical adjustment of +90° / -40°. Phospho-chromatised and polyester powder coated die-cast copper-free aluminium base and head, tempered safety glass, moulded silicone gaskets, with screws in stainless steel. Built-in LED driver, with 6 x CREE "XHP35" LED. IP66 rating.

101607

38W

CCT	Beam Angle	lm	lm/w	Finish	Dimming
.27 2700°K	.04 4°	4047	106.50	.01 RAL 9006	.0 ON/OFF
	.10 10°	4000	105.26	.02 RAL 7016	.1 1-10 V
	.28 28°	4085	107.50	.03 RAL 9005	.D DALI
	.55 55°	3400	89.47		
.30 3000°K	.04 4°	4.300	113.15		
	.10 10°	4.260	112.10		
	.28 28°	4.210	110.79		
	.55 55°	3.579	94.17		
.40 4000°K	.04 4°	4.400	115.79		
	.10 10°	4.360	114.74		
	.28 28°	4.310	113.42		
	.55 55°	3.664	96,41		

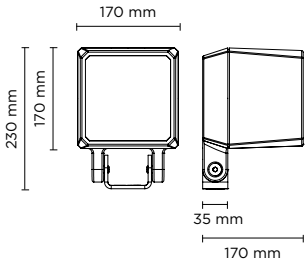

PRODUCT WEIGHT 4,50 kg



Qubo Maxi DMX RGBW

Floodlight for outdoor installation on a façade/wall, with U shape fixing bracket allowing vertical adjustment of +90° / -40°. Phospho-chromatised and polyester powder coated die-cast copper-free aluminium base and head, tempered safety glass, moulded silicone gaskets, with screws in stainless steel. Built-in LED driver, DMX driver integrated; with 6 x CREE "XML" RGBW LED. IP66 rating.

Code Example

101607.RW.**12**.**01**.**D**

Accessories p. 23

101607
28W

CCT	Beam Angle	lm	lm/w	Finish	Dimming
.RW RGBW	.12 12°	1.000	35.71	.01 RAL 9006	.D DALI
	.25 25°	992	35.43	.02 RAL 7016	.X DMX
	.35 35°	981	35.04	.03 RAL 9005	

INTEGRATED ACCESSORIES

101601.27.**04**.**01**.**0**.**_ _**

Built-in accessories to be requested when ordering example 101601.27.04.01.0.HC



.HC

HONEYCOMB

A honeycomb structure designed to shield the light beam, reduce glare, and eliminate direct exposure to the light source. **Compatible for all products of the series.**



LUMINAIRE SUITABLE FOR POLE MOUNTING IN SINGLE OR MULTIPLE COMBINATIONS

p. 376

ACCESSORIES NOT INCLUDED

Accessories to be ordered separately.



AC044

SPIKE

Ground-mounted installation accessory. **Compatible for all products of the series.**



GLARE SHIELD

Minimizes glare and optimizes beam direction for precise lighting.

Available for:

AC075

FOR ALL QUBO MICRO ITEM

AC076

FOR ALL QUBO MINI ITEMS

AC077

FOR ALL QUBO MEDIUM ITEMS

AC078

FOR ALL QUBO MAXI ITEMS



AC038

TREE STRAP

Fastening system for securing lighting fixtures to trees.

Compatible for all products of the series.

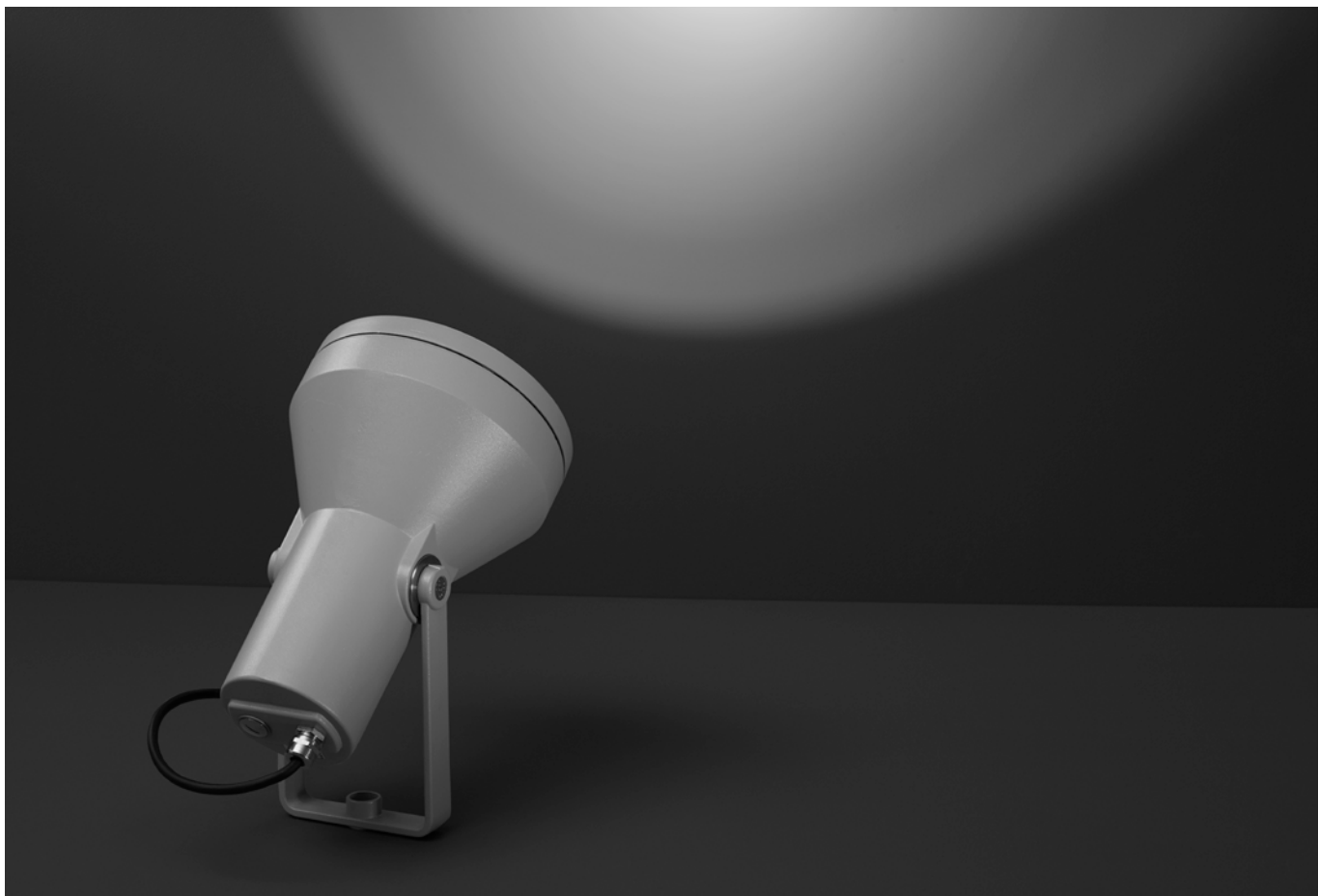

Flash

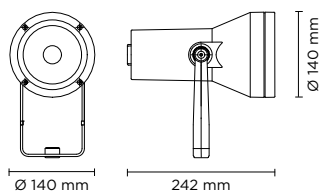

PRODUCT WEIGHT 2,60 kg



Code Example

101101.27.10.01.0



Accessories p. 27

Flash Medium

Round floodlight for outdoor installation on a façade/wall. Phospho-chromatised and polyester powder coated die-cast copper-free aluminium body, tempered safety glass, moulded silicone gasket and stainless steel screws. Built-in LED driver 220-240V 50-60Hz, with 5 CREE XP-G3 high-power LED. IP65 rating.

101101
8W

CCT	Beam Angle	lm	lm/w
.27 2700°K	.10 10°	684	85.50
	.30 30°	650	81.25
	.45 45°	618	77.25
.30 3000°K	.10 10°	720	90.00
	.30 30°	684	85.50
	.45 45°	650	81.25
.40 4000°K	.10 10°	750	93.75
	.30 30°	713	89.13
	.45 45°	677	84.63

Finish	Dimming
.01  RAL 9006	.0 ON/OFF
.02  RAL 7016	.1 1-10 V
.03  RAL 9005	.D DALI

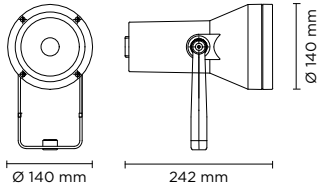

PRODUCT WEIGHT 2,60 kg



Flash Medium COB

Code Example

101102.27.35.01.0

Accessories p. 27

Round floodlight for outdoor installation on a façade/wall. Phospho-chromatised and polyester powder coated die-cast copper-free aluminium body, tempered safety glass, moulded silicone gasket and stainless steel screws. Built-in LED driver 220-240V 50-60Hz, with 1 CREE CXA 1512 COB LED. IP65 rating.

101102

18W

CCT	Beam Angle	lm	lm/w	Finish	Dimming
.27 2700°K	.35 35°	1454	80.78	.01 RAL 9006	.0 ON/OFF
.30 3000°K	.35 35°	1.530	85.00	.02 RAL 7016	.1 1-10 V
.40 4000°K	.35 35°	1.700	94.44	.03 RAL 9005	.D DALI

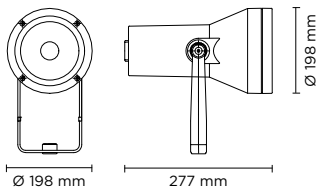

PRODUCT WEIGHT 3,50 kg



Flash Maxi

Code Example

101103.27.10.01.0

Accessories p. 27

Round floodlight for outdoor installation on a façade/wall. Phospho-chromatised and polyester powder coated die-cast copper-free aluminium body, tempered safety glass, moulded silicone gasket and stainless steel screws. Built-in LED driver 220-240V 50-60Hz, with 8 CREE XP-G3 high-power LED. IP65 rating.

101103

12W

CCT	Beam Angle	lm	lm/w	Finish	Dimming
.27 2700°K	.10 10°	1094	91.17	.01 RAL 9006	.0 ON/OFF
	.30 30°	1040	86.67		
	.45 45°	988	82.33		
.30 3000°K	.10 10°	1.152	96.00	.02 RAL 7016	.1 1-10 V
	.30 30°	1.095	91.25		
	.45 45°	1.040	86.67		
.40 4000°K	.10 10°	1.200	100.00	.03 RAL 9005	.D DALI
	.30 30°	1.140	95.00		
	.45 45°	1.083	90.25		

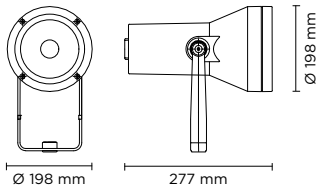

PRODUCT WEIGHT 3,50 kg



Code Example

101104.27.35.01.0

Accessories p. 27

Flash Maxi COB

Round floodlight for outdoor installation on a façade/wall. Phospho-chromatised and polyester powder coated die-cast copper-free aluminium body, tempered safety glass, moulded silicone gasket and stainless steel screws. Built-in LED driver 220-240V 50-60Hz, with 1 CREE CXB 2530 COB LED. IP65 rating.

CCT	Beam Angle	lm	lm/w	Finish	Dimming
101104 36W	.27 2700°K	.35 35°	2945 81.81	.01 RAL 9006	.0 ON/OFF
	.30 3000°K	.35 35°	3.100 86.10	.02 RAL 7016	.D DALI
	.40 4000°K	.35 35°	3.300 91.66	.03 RAL 9005	.1 1-10 V

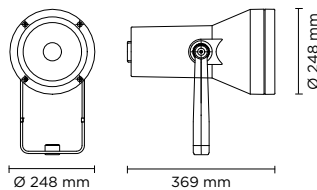

PRODUCT WEIGHT 5,00 kg



Code Example

101105.27.10.01.0

Accessories p. 27

Flash Mega

Round floodlight for outdoor installation on a façade/wall. Phospho-chromatised and polyester powder coated die-cast copper-free aluminium body, tempered safety glass, moulded silicone gasket and stainless steel screws. Built-in LED driver 220-240V 50-60Hz, with 15 CREE XP-G3 high-power LED. IP65 rating.

CCT	Beam Angle	lm	lm/w	Finish	Dimming
101105 22W	.27 2700°K	.10 10°	2.052 93.27	.01 RAL 9006	.0 ON/OFF
		.30 30°	1.949 88.59	.02 RAL 7016	.1 1-10 V
		.45 45°	1.852 84.18	.03 RAL 9005	.D DALI
	.30 3000°K	.10 10°	2.160 98.18		
		.30 30°	2.052 93.27		
		.45 45°	1.949 88.60		
	.40 4000°K	.10 10°	2.250 102.28		
		.30 30°	2.137 97.14		
		.45 45°	2.030 92.27		

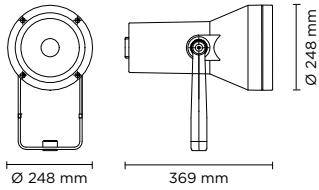

PRODUCT WEIGHT 5,00 kg



Flash Mega COB

Code Example

101106, .27, .35, .01, .0

Accessories p. 27

Round floodlight for outdoor installation on a façade/wall. Phospho-chromatised and polyester powder coated die-cast copper-free aluminium body, tempered safety glass, moulded silicone gasket and stainless steel screws. Built-in LED driver 220-240V 50-60Hz, with 1 CREE CXB 3070 COB LED. IP65 rating.

	CCT	Beam Angle	lm	lm/w	Finish	Dimming
101106	.27 2700°K	.35 35°	4.494	90.00	.01 RAL 9006	.0 ON/OFF
55W	.30 3000°K	.35 35°	4.730	86.00	.02 RAL 7016	.1 1-10 V
	.40 4000°K	.35 35°	4.980	90.54	.03 RAL 9005	.D DALI

ACCESSORIES NOT INCLUDED

Accessories to be ordered separately.



GLARE SHIELD

Minimizes glare and optimizes beam direction for precise lighting.

Available for:

AC026

FOR ALL FLASH MEDIUM ITEMS

AC027

FOR ALL FLASH MAXI ITEMS



Book

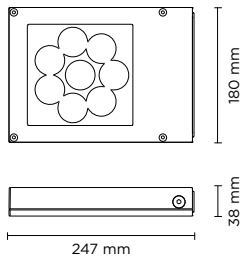

PRODUCT WEIGHT 2,50 kg



Code Example

109001.27.10.01.0

Book Medium

Square floodlight for outdoor installation on a façade/wall. Phospho-chromatised and polyester powder coated die-cast copper-free aluminium body, tempered safety glass, moulded silicone gasket and stainless steel screws. Built-in LED driver 220-240V 50-60Hz, with 8 CREE XP-G3 LED. IP65 rating.

109001

12W

CCT*	Beam Angle	lm	lm/w	Finish	Dimming
.27 2700°K	.10 10°	1.094	91.17	.01 RAL 9006	.0 ON/OFF
	.30 30°	1.040	86.67	.02 RAL 7016	
	.45 45°	988	82.33	.03 RAL 9005	
.30 3000°K	.10 10°	1.152	96.00		
	.30 30°	1.095	91.25		
	.45 45°	1.040	86.67		
.40 4000°K	.10 10°	1.200	100.00		
	.30 30°	1.140	95.00		
	.45 45°	1.083	90.25		

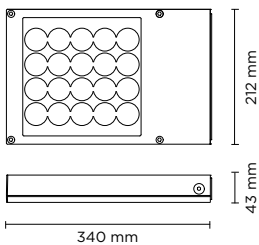

PRODUCT WEIGHT 2,80 kg



Code Example

109002.27.10.01.0

Book Maxi

Square floodlight for outdoor installation on a façade/wall. Phospho-chromatised and polyester powder coated die-cast copper-free aluminium body, tempered safety glass, moulded silicone gasket and stainless steel screws. Built-in LED driver 220-240V 50-60Hz, with 20 CREE XP-G3 LED. IP65 rating.

109002

30W

CCT*	Beam Angle	lm	lm/w	Finish	Dimming
.27 2700°K	.10 10°	2.736	91.2	.01 RAL 9006	.0 ON/OFF
	.30 30°	2.599	86.63	.02 RAL 7016	
	.45 45°	2.470	82.33	.03 RAL 9005	
.30 3000°K	.10 10°	2.880	96.00		
	.30 30°	2.736	91.20		
	.45 45°	2.600	86.67		
.40 4000°K	.10 10°	3.000	100.00		
	.30 30°	2.850	95.00		
	.45 45°	2.708	90.26		



Flamingo

Nava + Arosio

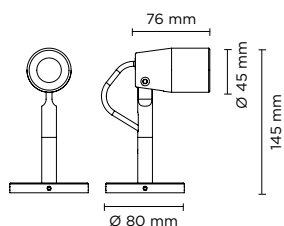

PRODUCT WEIGHT 1,70 kg



Code Example

101701 .27 .08 .03 .0

Accessories p. 32

Flamingo Micro

Diam. 45 mm micro-projector for external use, ideal to light bushes, flowerbed and gardens in general. Body made in turned and anodized aluminum. In horizontal axis it can be oriented up to 30° down and up to 90° up. Remote 24V DC driver needed, with 1 x CREE "XPG2" LED. IP66 rating.

101701

2W

CCT	Beam Angle	lm	lm/w
.27 2700°K	.08 8°	90	45.00
	.20 20°	86	43.00
	.40 40°	95	47.50
.30 3000°K	.08 8°	100	50.00
	.20 20°	95	47.50
	.40 40°	90	45.00
.40 4000°K	.08 8°	105	52.50
	.20 20°	100	50.00
	.40 40°	95	47.50

Finish

.03 ■ RAL 9005

Dimming

.0 ON/OFF

Remote Driver Selection Flamingo Micro

Brand	Manufacturer code	Type	Watt	IP Rate	Number of fixtures
Meanwell	LPV-20-24	constant voltage 24V DC	20W	IP67	min 1 - max 3
Meanwell	LPV-35-24	constant voltage 24V DC	35W	IP67	min 1 - max 5
Meanwell	LPV-60-24	constant voltage 24V DC	60W	IP67	min 1 - max 9

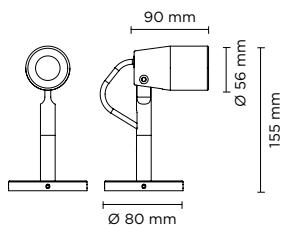

PRODUCT WEIGHT 1,80 kg



Flamingo Mini

Diam. 56 mm micro-projector for external use, ideal to light bushes, flowerbed and gardens in general. Body made in turned and anodized aluminum. In horizontal axis it can be oriented up to 30° down and up to 90° up. Remote 24V DC driver needed, with 1 x CREE "XHP35" LED. IP66 rating.

Code Example

101702, .27, .04, .03, 0

Accessories p. 32

101702

6W

CCT	Beam Angle	lm	lm/w	Finish	Dimming
.27 2700°K	.04 4°	465	77.50	.03 RAL 9005	.0 ON/OFF
	.10 10°	450	75.00		
	.28 28°	485	80.83		
	.55 55°	383	63.83		
.30 3000°K	.04 4°	510	85.00	.03 RAL 9005	.0 ON/OFF
	.10 10°	489	81.50		
	.28 28°	474	79.00		
	.55 55°	403	67.15		
.40 4000°K	.04 4°	520	86.67	.03 RAL 9005	.0 ON/OFF
	.10 10°	499	83.17		
	.28 28°	484	80.67		
	.55 55°	411	68.57		

Remote Driver Selection

Brand	Manufacturer code	Type	Watt	IP Rate	Number of fixtures
Meanwell	LPV-20-24	Constant Voltage 24V DC	20W	IP67	min 1 - max 3
Meanwell	LPV-35-24	Constant Voltage 24V DC	35W	IP67	min 1 - max 5
Meanwell	LPV-60-24	Constant Voltage 24V DC	60W	IP67	min 1 - max 9

INTEGRATED ACCESSORIES

101701 . 27 . 08 . 03 . 0 . _ _

Built-in accessories to be requested when ordering
example 101701.27.08.03.0.HC

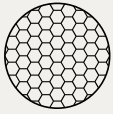

.HC

HONEYCOMB

A honeycomb structure designed to shield the light beam, reduce glare, and eliminate direct exposure to the light source. **Compatible for all products of the series.**

ACCESSORIES NOT INCLUDED

Accessories to be ordered separately.



AC044

SPIKE

For ground-mounted installation. **Compatible for all products of the series.**



AC038

TREE STRAP

Fastening system for securing lighting fixtures to trees. **Compatible for all products of the series.**



300 mm

AC068



600 mm

AC069

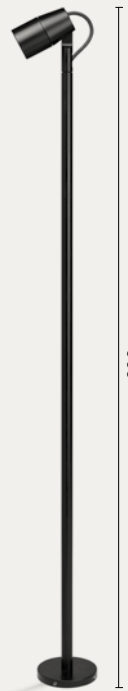

900 mm

AC070

AC068	PIPE L 300 MM	300mm extension pipe, anodized aluminum.
AC069	PIPE L 600 MM	600mm extension pipe, anodized aluminum.
AC070	PIPE L 900 MM	900mm extension pipe, anodized aluminum.





Coiny

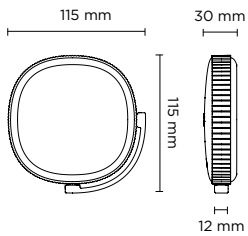

PRODUCT WEIGHT 1,20 kg



Coiny

Code Example

102101 | .27 | .18 | .01 | 0

Accessories p. 35

Projector for outdoor installation on a façade/wall. Phospho-chromatised and polyester powder coated die-cast copper-free aluminium, tempered safety glass, moulded silicone gasket and stainless steel screws. With 1 direct 220-240V LUMENS "EDC 38C" COB LED. IP66 rating.

102101

8W

CCT	Beam Angle	lm	lm/w	Finish	Dimming
.27 2700°K	.18 18°	380	47.50	.01 RAL 9006	.0 ON/OFF
	.36 36°	371	46.38	.02 RAL 7016	
	.60 60°	356	44.50	.03 RAL 9005	
.30 3000°K	.18 18°	400	50.00		
	.36 36°	390	48.75		
	.60 60°	375	46.88		
.40 4000°K	18° 18°	410	51.25		
	36° 36°	400	50.00		
	60° 60°	385	48.13		



INTEGRATED ACCESSORIES

102101 | 27 | 18 | 01 | 0 | _ _

Built-in accessories to be requested when ordering
example 102101.27.18.01.0.HC



.HC

HONEYCOMB

A honeycomb structure designed to shield the light beam, reduce glare, and eliminate direct exposure to the light source. **Compatible for all products of the series.**

ACCESSORIES NOT INCLUDED

Accessories to be ordered separately.



AC044

SPIKE

For ground-mounted installation.
Compatible for all products of the series.



.AC111

VISOR

Minimizes glare and optimizes beam direction for precise lighting.
Compatible for all products of the series.



City Wall

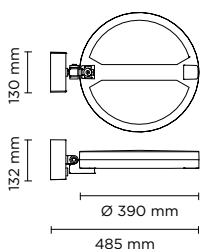

PRODUCT WEIGHT 6,50 kg



Code Example

101201.30.CP.01.0

City Wall 12+12

Round wall mounted luminaire for outdoor installation, with downward asymmetric light distribution. Phospho-chromatised and polyester powder coated die-cast copper-free aluminium body, tempered safety glass, moulded silicone gasket and stainless steel screws. Built-in LED driver/s, with 24 CREE XP-G3 LED. IP66 rating.

CCT	Beam Angle	lm	lm/w	Finish	Dimming
101201 36W	.30 3000°K	.CP Cycle route pedestrian 3.456	96.00	.01 RAL 9006	.0 ON/OFF
		.ST Street 3.456	96.00	.02 RAL 7016	.1 1-10 V
				.03 RAL 9005	.D DALI

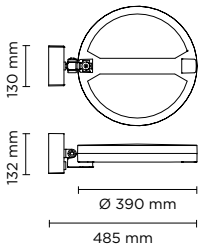

PRODUCT WEIGHT 6,50 kg



Code Example

101202.30.CP.01.0

City Wall 24+24

Round wall mounted luminaire for outdoor installation, with downward asymmetric light distribution. Phospho-chromatised and polyester powder coated die-cast copper-free aluminium body, tempered safety glass, moulded silicone gasket and stainless steel screws. Built-in LED driver/s, with 48 CREE XP-G3 LED. IP66 rating.

101202
72W

CCT	Beam Angle	lm	lm/w	Finish	Dimming
.30 3000°K	.CP Cycle route pedestrian	6.192	96.00	.01 RAL 9006	.0 ON/OFF
	.ST Street	6.192	96.00	.02 RAL 7016	.1 1-10 V
				.03 RAL 9005	.D DALI

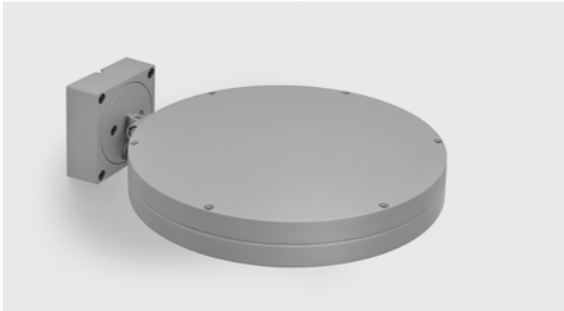
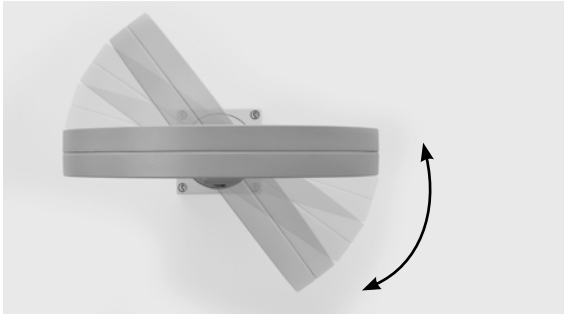



Zeus

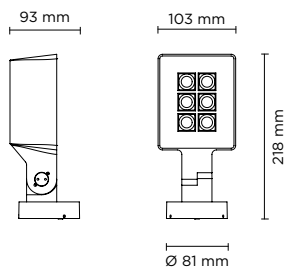

PRODUCT WEIGHT 1,50 kg



Zeus Mini

Floodlight for outdoor installation on a façade/wall, with 355° swivel base and allowing horizontal adjustment of +90° / -40°. Phospho-chromatised and polyester powder coated die-cast copper-free aluminium base and head, tempered safety glass, moulded silicone gaskets and o-rings, with screws in stainless steel. Swivel joint with graduated scale and mechanical aiming lock. Built-in LED driver, with 4 CREE "XP-G2" LED. IP66 rating.

Code Example

101501.**30**.**15**.**01**.**0**

Accessories p. 42

101501
8W

CCT	Beam Angle	lm	lm/w	Finish	Dimming
.30 3000°K	.15 15°	768	96.00	.01 RAL 9006	.0 ON/OFF
	.35 35°	745	93.13	.02 RAL 7016	
	.55 55°	710	88.75	.03 RAL 9005	
.40 4000°K	.15 15°	788	98.50		
	.35 35°	765	95.63		
	.55 55°	730	91.25		

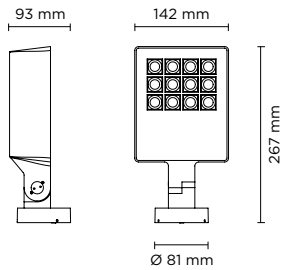

PRODUCT WEIGHT 2,20 kg



Code Example

101502 .30 .15 .01 .0

Accessories p. 42

Zeus Medium

Floodlight for outdoor installation on a façade/wall, with 355° swivel base and allowing horizontal adjustment of +90° / -40°. Phospho-chromatised and polyester powder coated die-cast copper-free aluminium base and head, tempered safety glass, moulded silicone gaskets and o-rings, with screws in stainless steel. Swivel joint with graduated scale and mechanical aiming lock. Built-in LED driver, with 12 CREE “XP-G2” LED. IP66 rating.

101502
20W

CCT	Beam Angle	lm	lm/w	Finish	Dimming
.30 3000°K	.15 15°	1.920	96.00	.01 RAL 9006	.0 ON/OFF
	.35 35°	1.862	93.13	.02 RAL 7016	.1 1-10 V
	.55 55°	1.775	88.75	.03 RAL 9005	.D DALI
.40 4000°K	.15 15°	1.970	98.50		
	.35 35°	1.913	95.63		
	.55 55°	1.825	91.25		

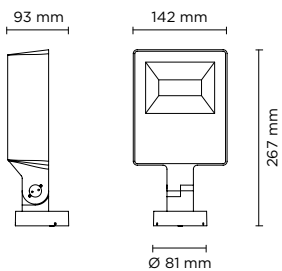

PRODUCT WEIGHT 2,20 kg



Code Example

101505 .30 .SW .01 .0

Accessories p. 42

Zeus Medium Symm

Floodlight for outdoor installation on a façade/wall, with 355° swivel base and allowing horizontal adjustment of +90° / -40°. Phospho-chromatised and polyester powder coated die-cast copper-free aluminium base and head, tempered safety glass, moulded silicone gaskets and o-rings, with screws in stainless steel. Symmetrical wide light distribution. Swivel joint with graduated scale and mechanical aiming lock. Built-in LED driver, with 56 x mid-power SAMSUNG 2835 LED. IP66 rating.

101505
20W

CCT	Beam Angle	lm	lm/w	Finish	Dimming
.30 3000°K	.SW 110°	1.510	75.50	.01 RAL 9006	.0 ON/OFF
				.02 RAL 7016	.1 1-10 V
				.03 RAL 9005	.D DALI
.40 4000°K	.SW 110°	1.560	78.00		

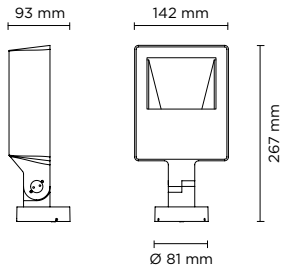

PRODUCT WEIGHT 2,20 kg



Zeus Medium Asymm

Code Example

101506.30.AS.O1.O

Accessories p. 42

Floodlight for outdoor installation on a façade/wall, with 355° swivel base and allowing horizontal adjustment of +90° / -40°. Phospho-chromatised and polyester powder coated die-cast copper-free aluminium base and head, tempered safety glass, moulded silicone gaskets and o-rings, with screws in stainless steel. Symmetrical wide light distribution. Swivel joint with graduated scale and mechanical aiming lock. Built-in LED driver, with 56 x mid-power SAMSUNG 2835 LED. IP66 rating.

101506
20W

CCT	Beam Angle	lm	lm/w	Finish	Dimming
.30 3000°K	.AS 110°x70°	1.560	78.00	.01 RAL 9006	.0 ON/OFF
.40 4000°K	.AS 110°x70°	1.610	80.50	.02 RAL 7016	.1 1-10 V
				.03 RAL 9005	.D DALI

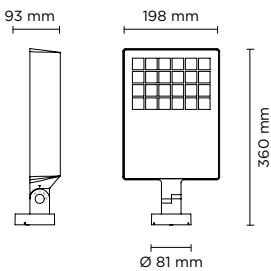

PRODUCT WEIGHT 3,50 kg



Zeus Maxi

Code Example

101503.30.15.O1.O

Accessories p. 42

Floodlight for outdoor installation on a façade/wall, with 355° swivel base and allowing horizontal adjustment of +90° / -40°. Phospho-chromatised and polyester powder coated die-cast copper-free aluminium base and head, tempered safety glass, moulded silicone gaskets and o-rings, with screws in stainless steel. Swivel joint with graduated scale and mechanical aiming lock. Built-in LED driver, with 24 CREE "XP-G2" LED. IP66 rating.

101503
38W

CCT	Beam Angle	lm	lm/w	Finish	Dimming
.30 3000°K	.15 15°	3.648	96.00	.01 RAL 9006	.0 ON/OFF
	.35 35°	3.539	93.13	.02 RAL 7016	.1 1-10 V
	.55 55°	3.372	88.75	.03 RAL 9005	.D DALI
.40 4000°K	.15 15°	3.743	98.50		
	.35 35°	3.634	95.63		
	.55 55°	3.468	91.25		

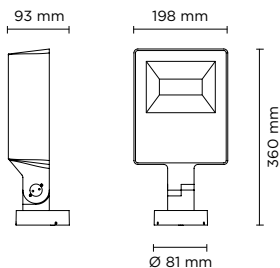

PRODUCT WEIGHT 3,50 kg



Code Example

101507.30.SW.01.0

Accessories p. 42

Zeus Maxi Symm

Floodlight for outdoor installation on a façade/wall, with 355° swivel base and allowing horizontal adjustment of +90° / -40°. Phospho-chromatised and polyester powder coated die-cast copper-free aluminium base and head, tempered safety glass, moulded silicone gaskets and o-rings, with screws in stainless steel. Symmetrical wide light distribution. Swivel joint with graduated scale and mechanical aiming lock. Built-in LED driver, with 120 x mid-power SAMSUNG 2835 LED. IP66 rating.

101507

42W

CCT	Beam Angle	lm	lm/w	Finish	Dimming
.30 3000°K	.SW 110°	3.900	92.86	.01 RAL 9006	.0 ON/OFF
.40 4000°K	.SW 110°	3.940	93.80	.02 RAL 7016	.1 1-10 V
				.03 RAL 9005	.D DALI

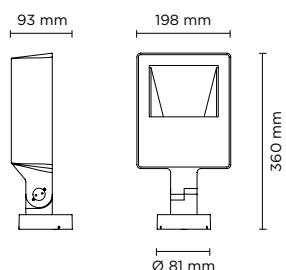

PRODUCT WEIGHT 3,50 kg



Code Example

101508.30.AS.01.0

Accessories p. 42

Zeus Maxi Asymm

Floodlight for outdoor installation on a façade/wall, with 355° swivel base and allowing horizontal adjustment of +90° / -40°. Phospho-chromatised and polyester powder coated die-cast copper-free aluminium base and head, tempered safety glass, moulded silicone gaskets and o-rings, with screws in stainless steel. Asymmetrical wide light distribution. Swivel joint with graduated scale and mechanical aiming lock. Built-in LED driver, with 120 x mid-power SAMSUNG 2835 LED. IP66 rating.

101508

42W

CCT	Beam Angle	lm	lm/w	Finish	Dimming
.30 3000°K	.AS 110°x70°	2.995	71.31	.01 RAL 9006	.0 ON/OFF
.40 4000°K	.AS 110°x70°	3.010	71.67	.02 RAL 7016	.1 1-10 V
				.03 RAL 9005	.D DALI

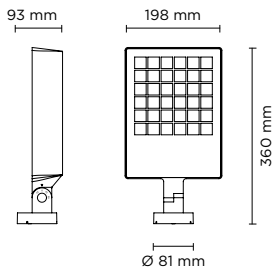

PRODUCT WEIGHT 3,50 kg



Zeus Mega

Code Example

101504.**30**.**15**.**01**.**0**

Accessories p. 42

Floodlight for outdoor installation on a façade/wall, with 355° swivel base and allowing horizontal adjustment of +90° / -40°. Phospho-chromatised and polyester powder coated die-cast copper-free aluminium base and head, tempered safety glass, moulded silicone gaskets and o-rings, with screws in stainless steel. Swivel joint with graduated scale and mechanical aiming lock. Built-in LED driver, with 36 CREE “XP-G2” LED. IP66 rating.

CCT	Beam Angle	lm	lm/w	Finish	Dimming
101504 56W	.30 3000°K	.15 15°	5.376 96.00	.01 RAL 9006	.0 ON/OFF
		.35 35°	5.216 93.13	.02 RAL 7016	.1 1-10 V
		.55 55°	4.970 88.75	.03 RAL 9005	.D DALI
.40 4000°K	.15 15°	5.516 98.50			
	.35 35°	5.355 95.63			
	.55 55°	5.110 91.25			

INTEGRATED ACCESSORIES

101501.**30**.**15**.**01**.**0**.**PP**

Built-in accessories to be requested when ordering
example 101501.30.15.01.0.**PP**

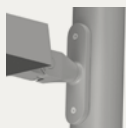

.PP

POLE PLATE

Pole plate for pole mounting of all Zeus models, suitable to be used with poles diam. min 76 mm and diam. max 120 mm. Can be positioned on various staggered levels or on a single level, with the same pole. Made in phospho-chromatised and polyester powder coated dia-cast copper-free aluminum material, moulded silicone gaskets and screws in stainless steel. **Compatible for all products of the series.**



LUMINAIRE SUIVABLE
FOR POLE MOUNTING
IN SINGLE OR MULTIPLE
COMBINATIONS

p. 358





Ring

Nava + Arosio

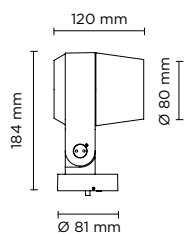

PRODUCT WEIGHT 1,50 kg

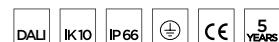

Code Example

101401.27.14.01.0

Accessories p. 51

Ring Mini COB

Floodlight for outdoor installation on a façade/wall, with 355° swivel base and allowing horizontal adjustment of +90° / -40°. Phospho-chromatised and polyester powder coated die-cast copper-free aluminium base and head, tempered safety glass, moulded silicone gaskets and o-rings, with screws in stainless steel. Swivel joint with graduated scale and mechanical aiming lock. Built-in LED driver, with 1 COB CREE "CXB 1310" LED. IP66 rating.

CCT	Beam Angle	lm	lm/w	Finish	Dimming	
						Code
101401 10W	.27 2700°K	.14 14°	1.045	104.50	.01 RAL 9006	.0 ON/OFF
		.35 35°	1.007	100.70	.02 RAL 7016	.D DALI
		.55 55°	950	95.00	.03 RAL 9005	
.30 3000°K	.14 14°	1.100	110.00			
	.35 35°	1.060	106.00			
	.55 55°	1.000	100.00			
.40 4000°K	.14 14°	1.200	120.00			
	.35 35°	1.140	114.00			
	.55 55°	1.083	108.00			

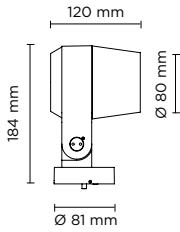

PRODUCT WEIGHT 1,50 kg



Code Example

101404,.27,.04,.01,.0

Accessories p. 51

Ring Mini HP

Floodlight for outdoor installation on a façade/wall, with 355° swivel base and allowing horizontal adjustment of +90° / -40°. Phospho-chromatised and polyester powder coated die-cast copper-free aluminium base and head, tempered safety glass, moulded silicone gaskets and o-rings, with screws in stainless steel. Swivel joint with graduated scale and mechanical aiming lock. Built-in LED driver, with 1 x CREE "XHP35" LED. IP66 rating.

101404
8W

CCT	Beam Angle	lm	lm/w	Finish	Dimming
.27 2700°K	.04 4°	629	78.62	.01 RAL 9006	.0 ON/OFF
	.10 10°	610	76.25	.02 RAL 7016	.D DALI
	.28 28°	656	82.00		
	.55 55°	519	64.88		
	.30 3000°K	.04 4°	690	86.25	.03 RAL 9005
.10 10°		662	82.75		
.28 28°		642	80.25		
.55 55°		546	68.21		
.40 4000°K		.04 4°	703	87.88	
	.10 10°	676	84.50		
	.28 28°	656	82.00		
	.55 55°	558	69.70		

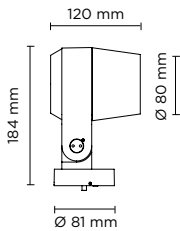

PRODUCT WEIGHT 1,50 kg



Code Example

101404,.RW,.12,.01,.X

Accessories p. 51

Ring Mini DMX RGBW

Floodlight for outdoor installation on a façade/wall, with 355° swivel base and allowing horizontal adjustment of +90° / -40°. Phospho-chromatised and polyester powder coated die-cast copper-free aluminium base and head, tempered safety glass, moulded silicone gaskets and o-rings, with screws in stainless steel. Swivel joint with graduated scale and mechanical aiming lock. Remote 24V DC power supply needed, DMX driver integrated; with 1 x CREE "XML" RGBW LED. IP66 rating.

101404
4,5W

CCT	Beam Angle	lm	lm/w	Finish	Dimming
.RW RGBW	.12 12°	160	35.55	.01 RAL 9006	.X DMX
	.25 25°	152	33.78	.02 RAL 7016	
	.35 35°	145	32.23	.03 RAL 9005	

Remote Driver Selection

Brand	Manufacturer code	Type	Watt	IP Rate	Number of fixtures
Meanwell	LPV-20-24	Constant Voltage 24V DC	20W	IP67	min 1 - max 3
Meanwell	LPV-35-24	Constant Voltage 24V DC	35W	IP67	min 1 - max 6

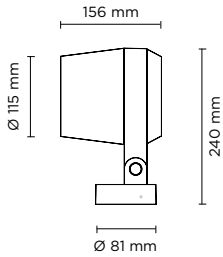

PRODUCT WEIGHT 2,50 kg



Ring Medium COB

Code Example

101402.27.14.01.0

Accessories p. 51

Floodlight for outdoor installation on a façade/wall, with 355° swivel base and allowing horizontal adjustment of +90° / -40°. Phospho-chromatised and polyester powder coated die-cast copper-free aluminium base and head, tempered safety glass, moulded silicone gaskets and o-rings, with screws in stainless steel. Swivel joint with graduated scale and mechanical aiming lock. Built-in LED driver, with 1 COB CREE "CXB 1512" LED. IP66 rating.

101402

16W

CCT	Beam Angle	lm	lm/w	Finish	Dimming
.27 2700°K	.14 14°	1.805	112.81	.01 RAL 9006	.0 ON/OFF
	.35 35°	1.722	107.62	.02 RAL 7016	.1 1-10 V
	.55 55°	1.636	102.25	.03 RAL 9005	.D DALI
.30 3000°K	.14 14°	1.900	118.75		
	.35 35°	1.813	113.31		
	.55 55°	1.722	107.62		
.40 4000°K	.14 14°	2.000	125.00		
	.35 35°	1.900	118.75		
	.55 55°	1.805	112.81		

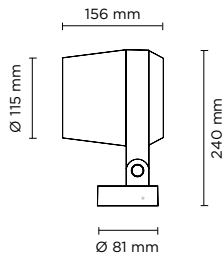

PRODUCT WEIGHT 2,50 kg



Ring Medium HP

Code Example

101405.27.04.01.0

Accessories p. 51

Floodlight for outdoor installation on a façade/wall, with 355° swivel base and allowing horizontal adjustment of +90° / -40°. Phospho-chromatised and polyester powder coated die-cast copper-free aluminium base and head, tempered safety glass, moulded silicone gaskets and o-rings, with screws in stainless steel. Swivel joint with graduated scale and mechanical aiming lock. Built-in LED driver, with 3 x CREE "XHP35" LED. IP66 rating.

101405

20W

CCT	Beam Angle	lm	lm/w	Finish	Dimming
.27 2700°K	.04 4°	1.900	95.00	.01 RAL 9006	.0 ON/OFF
	.10 10°	1.853	92.65	.02 RAL 7016	.1 1-10 V
	.28 28°	1.948	97.40	.03 RAL 9005	.D DALI
	.55 55°	1.575	78.75		
.30 3000°K	.04 4°	2.050	102.50		
	.10 10°	2.000	100.00		
	.28 28°	1.950	97.50		
	.55 55°	1.722	107.62		
.40 4000°K	.04 4°	2.100	105.00		
	.10 10°	2.050	102.50		
	.28 28°	2.000	100.00		
	.55 55°	1.722	107.62		

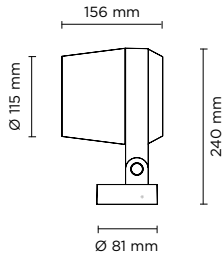

PRODUCT WEIGHT 2,50 kg



Ring Medium DMX RGBW

Floodlight for outdoor installation on a façade/wall, with 355° swivel base and allowing horizontal adjustment of +90° / -40°. Phospho-chromatised and polyester powder coated die-cast copper-free aluminium base and head, tempered safety glass, moulded silicone gaskets and o-rings, with screws in stainless steel. Swivel joint with graduated scale and mechanical aiming lock. Built-in LED driver, DMX driver integrated; with 3 x CREE "XML" RGBW LED. IP66 rating.

Code Example

101405·RW·12·01·D

Accessories p. 51

101405

14W

CCT	Beam Angle	lm	lm/w	Finish	Dimming
.RW RGBW	.12 12°	480	34.28	.01 RAL 9006	.D DALI
	.25 25°	468	33.43	.02 RAL 7016	.X DMX
	.35 35°	457	32.65	.03 RAL 9005	

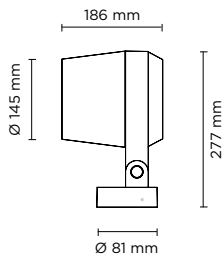

PRODUCT WEIGHT 4,00 kg



Ring Maxi COB

Floodlight for outdoor installation on a façade/wall, with 355° swivel base and allowing horizontal adjustment of +90° / -40°. Phospho-chromatised and polyester powder coated die-cast copper-free aluminium base and head, tempered safety glass, moulded silicone gaskets and o-rings, with screws in stainless steel. Swivel joint with graduated scale and mechanical aiming lock. Built-in LED driver, with 1 COB CREE "CXB 2540" LED. IP66 rating.

Code Example

101403·27·14·01·0

Accessories p. 51

101403

42W

CCT	Beam Angle	lm	lm/w	Finish	Dimming
.27 2700°K	.14 14°	4.703	111.98	.01 RAL 9006	.0 ON/OFF
	.35 35°	4.514	107.48	.02 RAL 7016	.1 1-10 V
	.55 55°	4.332	103.14	.03 RAL 9005	.D DALI
.30 3000°K	.14 14°	4.950	117.85		
	.35 35°	4.752	113.14		
	.55 55°	4.560	108.57		
.40 4000°K	.14 14°	5.265	125.36		
	.35 35°	5.000	119.05		
	.55 55°	4.770	113.57		

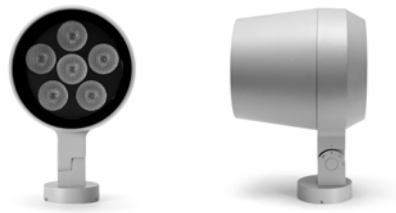
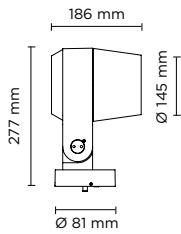

PRODUCT WEIGHT 4,00 kg



Code Example

101406·.27·.04·.01·.0

Accessories p. 51

Ring Maxi HP

Floodlight for outdoor installation on a façade/wall, with 355° swivel base and allowing horizontal adjustment of +90° / -40°. Phospho-chromatised and polyester powder coated die-cast copper-free aluminium base and head, tempered safety glass, moulded silicone gaskets and o-rings, with screws in stainless steel. Swivel joint with graduated scale and mechanical aiming lock. Built-in LED driver, with 6 x CREE "XHP35" LED. IP66 rating.

101406

38W

CCT	Beam Angle	Im	Im/w	Finish	Dimming
.27 2700°K	.04 4°	4.047	106.50	.01 RAL 9006	.0 ON/OFF
	.10 10°	4.000	105.26	.02 RAL 7016	.1 1-10 V
	.28 28°	4.085	107.50	.03 RAL 9005	.D DALI
	.55 55°	3.400	89.47		
.30 3000°K	.04 4°	4.300	113.15		
	.10 10°	4.260	112.10		
	.28 28°	4.210	110.79		
	.55 55°	3.579	94.17		
.40 4000°K	.04 4°	4.400	115.79		
	.10 10°	4.360	114.74		
	.28 28°	4.310	113.42		
	.55 55°	3.664	96.41		

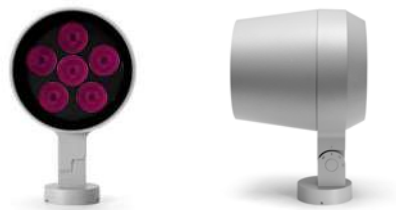
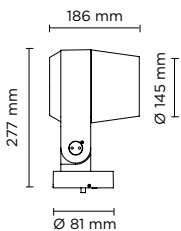

PRODUCT WEIGHT 4,00 kg



Code Example

101406·.RW·.12·.01·.D

Accessories p. 51

Ring Maxi DMX RGBW

Floodlight for outdoor installation on a façade/wall, with 355° swivel base and allowing horizontal adjustment of +90° / -40°. Phospho-chromatised and polyester powder coated die-cast copper-free aluminium base and head, tempered safety glass, moulded silicone gaskets and o-rings, with screws in stainless steel. Swivel joint with graduated scale and mechanical aiming lock. Built-in LED driver, DMX driver integrated; with 6 x CREE "XML" RGBW LED. IP66 rating.

101406

28W

CCT	Beam Angle	Im	Im/w	Finish	Dimming
.RW RGBW	.12 12°	1.000	35.71	.01 RAL 9006	.D DALI
	.25 25°	992	35.43	.02 RAL 7016	.X DMX
	.35 35°	981	35.04	.03 RAL 9005	

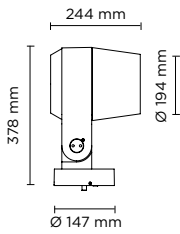

PRODUCT WEIGHT 8,00 kg



Code Example

101407.27.20.01.0

Accessories p. 51

Ring Mega COB

Floodlight for outdoor installation on a façade/wall, with 355° swivel base and allowing horizontal adjustment of +90° / -40°. Phospho-chromatised and polyester powder coated die-cast copper-free aluminium base and head, tempered safety glass, moulded silicone gaskets and o-rings, with screws in stainless steel. Swivel joint with graduated scale and mechanical aiming lock. Built-in LED driver, with 1 COB CREE “CXB 3590” LED. IP66 rating.

	CCT	Beam Angle	lm	lm/w	Finish	Dimming
101407	.27 2700°K	.20 20°	9.595	116.95	.01 RAL 9006	.0 ON/OFF
		.40 40°	9.519	116.09	.02 RAL 7016	.D DALI
82W	.30 3000°K	.20 20°	10.100	123.17	.03 RAL 9005	
		.40 40°	10.020	122.20		
	.40 4000°K	.20 20°	10.200	124.39		
		.40 40°	10.120	123.42		

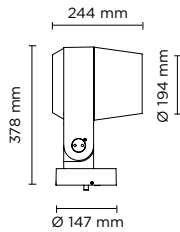

PRODUCT WEIGHT 8,00 kg



Code Example

101408.27.04.01.0

Accessories p. 51

Ring Mega HP

Floodlight for outdoor installation on a façade/wall, with 355° swivel base and allowing horizontal adjustment of +90° / -40°. Phospho-chromatised and polyester powder coated die-cast copper-free aluminium base and head, tempered safety glass, moulded silicone gaskets and o-rings, with screws in stainless steel. Swivel joint with graduated scale and mechanical aiming lock. Built-in LED driver, with 12 x CREE “XHP35” LED. IP66 rating.

	CCT	Beam Angle	lm	lm/w	Finish	Dimming
101408	.27 2700°K	.04 4°	8.978	102.02	.01 RAL 9006	.0 ON/OFF
		.10 10°	8.911	101.26		
		.28 28°	9.025	102.56		
		.55 55°	7.574	86.07		
88W	.30 3000°K	.04 4°	9.500	107.96	.02 RAL 7016	.D DALI
		.10 10°	9.450	107.38		
		.28 28°	9.380	106.59		
		.55 55°	7.973	90.60		
	.40 4000°K	.04 4°	9.600	109.09	.03 RAL 9005	
		.10 10°	9.550	108.52		
		.28 28°	9.480	107.73		
		.55 55°	8.058	91.57		

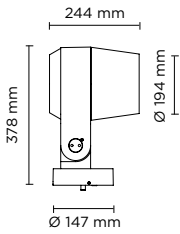

PRODUCT WEIGHT 8,00 kg



Ring Mega DMX RGBW

Code Example

101408.RW.**12**.**01**.X

Accessories p. 51

Floodlight for outdoor installation on a façade/wall, with 355° swivel base and allowing horizontal adjustment of +90° / -40°. Phospho-chromatised and polyester powder coated die-cast copper-free aluminium base and head, tempered safety glass, moulded silicone gaskets and o-rings, with screws in stainless steel. Swivel joint with graduated scale and mechanical aiming lock. Built-in LED driver, DMX driver integrated; with 12 x CREE "XML" RGBW LED. IP66 rating.

	CCT	Beam Angle	lm	lm/w	Finish	Dimming
101408	.RW RGBW	.12 12°	2.000	35.71	.01 RAL 9006	.X DMX
56W		.25 25°	1.984	35.43	.02 RAL 7016	
		.35 35°	1.962	35.04	.03 RAL 9005	



INTEGRATED ACCESSORIES

101401.27.14.01.0. _ _ _

Built-in accessories to be requested when ordering
example 101401.27.14.01.0.HC



.EL

ELLIPTICAL GLASS

Elliptical diffusion lens to shape the light in a more directional and asymmetric way.

Available for

- ALL RING **MINI** ITEMS
 - ALL RING **MEDIUM** ITEMS
 - ALL RING **MAXI** ITEM
- except for **DMX RGBW** version



.PS

PRISMATIC GLASS

Designed to ensure uniform light distribution and glare reduction.

Available for

- ALL RING **MINI** ITEMS
 - ALL RING **MEDIUM** ITEMS
 - ALL RING **MAXI** ITEM
- except for **DMX RGBW** version



.HC

HONEYCOMB

A honeycomb structure designed to shield the light beam, reduce glare, and eliminate direct exposure to the light source. **Compatible for all products of the series.**

ACCESSORIES NOT INCLUDED

Accessories to be ordered separately.



AC044

SPIKE

Ground-mounted installation accessory.

Available for:

- RING **MINI** ITEMS
- RING **MEDIUM** ITEMS
- RING **MAXI** ITEMS



AC103

SPIKE

Ground-mounted installation accessory.

Available for:

- RING **MEGA** ITEMS



GLARE SHIELD

Minimizes glare and optimizes beam direction for precise lighting.

Available for:

- AC045**
FOR ALL RING **MINI** ITEMS
- AC046**
FOR ALL RING **MEDIUM** ITEMS
- AC047**
FOR ALL RING **MAXI** ITEMS
- AC086**
FOR ALL RING **MEGA** ITEMS



AC038

TREE STRAP

Fastening system for securing lighting fixtures to trees. **Compatible for all products of the series.**



LUMINAIRE SUITABLE
FOR POLE MOUNTING
IN SINGLE OR MULTIPLE
COMBINATIONS

p. 364







Nanospot

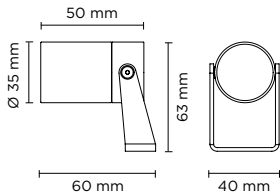

PRODUCT WEIGHT 0,40 kg



Code Example

101901 · .27 · .10 · .01 · .0

Accessories p. 58

Nanospot Micro HP

Projector for outdoor installation on a façade/wall. Body in anodized aluminum with phospho-chromatised and polyester powder coating, bracket in stainless steel, tempered safety glass, moulded silicone gasket and stainless steel screws. Constant voltage 24V DC remote driver needed. With 1 x XP-G3 CREE LED. IP66 rating.

101901

3W

CCT	Beam Angle	lm	lm/w	Finish	Dimming
.27 2700°K	.10 10°	238	79.33	.01 RAL 9006	.0 ON/OFF
	.30 30°	228	76.00	.02 RAL 7016	
	.45 45°	219	73.0	.03 RAL 9005	
.30 3000°K	.10 10°	250	83.33		
	.30 30°	240	80.00		
	.45 45°	230	76.66		
.40 4000°K	.10 10°	270	90.00		
	.30 30°	260	86.66		
	.45 45°	250	83.33		

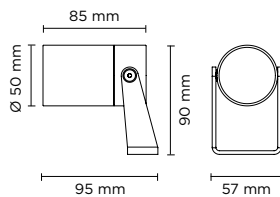

PRODUCT WEIGHT 0,60 kg



Code Example

101902 · .27 · .20 · .01 · .0

Accessories p. 58

Nanospot Mini COB

Projector for outdoor installation on a façade/wall. Body in anodized aluminum with phospho-chromatised and polyester powder coating, bracket in stainless steel, tempered safety glass, moulded silicone gasket and stainless steel screws. With 1 direct 220-240V LUMENS "EDC 38C" COB LED. IP66 rating.

101902

8W

CCT	Beam Angle	lm	lm/w	Finish	Dimming
.27 2700°K	.20 20°	380	47.50	.01 RAL 9006	.0 ON/OFF
	.40 40°	371	46.38	.02 RAL 7016	
.30 3000°K	.20 20°	400	50.00	.03 RAL 9005	
	.40 40°	390	48.75		
.40 4000°K	.20 20°	410	51.25		
	.40 40°	400	50.00		

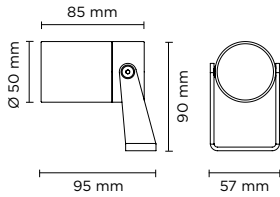

PRODUCT WEIGHT 0,60 kg



Nanospot Mini HP

Code Example

101903, .27, .04, .01, 0

Accessories p. 58

Projector for outdoor installation on a façade/wall. Body in anodized aluminum with phospho-chromatised and polyester powder coating, bracket in stainless steel, tempered safety glass, moulded silicone gasket and stainless steel screws. Constant current max 700mA remote driver needed. With 1 x CREE XHP35 LED. IP66 rating.

101903
Max 10W

CCT	Beam Angle	Finish	Dimming
.27 2700°K	.04 4°	.01 RAL 9006	.0 ON/OFF
	.10 10°	.02 RAL 7016	
	.28 28°	.03 RAL 9005	
	.55 55°		
.30 3000°K	.04 4°		
	.10 10°		
	.28 28°		
	.55 55°		
.40 4000°K	.04 4°		
	.10 10°		
	.28 28°		
	.55 55°		

CCT	Beam Angle	350 mA LED POWER 5W		500 mA LED POWER 7W		700 mA LED POWER 10W	
		lm	lm/w	lm	lm/w	lm	lm/w
2700°K	4°	485	96.90	656	93.64	862	86.20
	10°	465	92.91	629	89.84	828	81.80
	28°	450	90.00	609	87.12	846	84.60
	55°	383	76.57	519	74.10	804	80.40
3000°K	4°	510	102.00	690	98.57	907	90.69
	10°	489	97.80	662	94.57	872	87.20
	28°	474	94.80	642	91.71	846	84.60
	55°	403	80.58	546	77.95	719	71.91
4000°K	4°	520	104.00	703	100.43	930	93.00
	10°	499	99.80	676	96.57	890	89.00
	28°	484	96.80	656	93.71	863	86.30
	55°	411	82.28	558	76.65	734	73.36



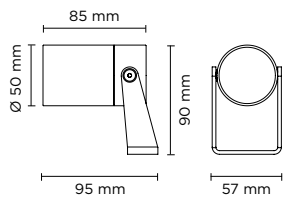

PRODUCT WEIGHT 0,60 kg

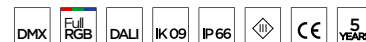

Code Example

101903.RW.12.01.D

Accessories p. 58

Nanospot Mini RGBW

Projector for outdoor installation on a façade/wall. Body in anodized aluminum with phosphochromatised and polyester powder coating, bracket in stainless steel, tempered safety glass, moulded silicone gasket and stainless steel screws. Remote 24V DC power supply needed, remote DMX interface needed; with 1 x CREE "XML" RGBW LED. IP66 rating.

101903

4,5W

CCT	Beam Angle	lm	lm/w	Finish	Dimming
.RW RGBW	.12 12°	160	35.55	.01 RAL 9006	.D DALI
	.25 25°	152	33.78	.02 RAL 7016	.X DMX
	.35 35°	145	32.23	.03 RAL 9005	

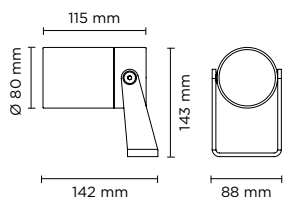

PRODUCT WEIGHT 1,50 kg



Code Example

101904.27.20.01.0

Accessories p. 58

Nanospot Medium COB

Projector for outdoor installation on a façade/wall. Body in anodized aluminum with phosphochromatised and polyester powder coating, bracket in stainless steel, tempered safety glass, moulded silicone gasket and stainless steel screws. With 1 direct 220-240V LUMENS "EDC 57C" COB LED. IP66 rating.

101904

15W

CCT	Beam Angle	lm	lm/w	Finish	Dimming
.27 2700°K	.20 20°	950	135.71	.01 RAL 9006	.0 ON/OFF
	.40 40°	931	133.00		
.30 3000°K	.20 20°	1.000	66.67	.02 RAL 7016	
	.40 40°	980	65.34		
.40 4000°K	.20 20°	1.050	70.00	.03 RAL 9005	
	.40 40°	1.030	68.67		

INTEGRATED ACCESSORIES

101901.27.10.01.0. _ _

Built-in accessories to be requested when ordering
example 101901.27.10.01.0.HC



.HC

HONEYCOMB

A honeycomb structure designed to shield the light beam, reduce glare, and eliminate direct exposure to the light source. **Compatible for all products of the series.**

ACCESSORIES NOT INCLUDED

Accessories to be ordered separately.



AC038

TREE STRAP

Fastening system for securing lighting fixtures to trees. **Compatible for all products of the series.**

ACCESSORIES NOT INCLUDED

Accessories to be ordered separately.



AC044

SPIKE

Ground-mounted installation accessory. **Compatible for all products of the series.**



GLARE SHIELD

Minimizes glare and optimizes beam direction for precise lighting.

Available for:

AC097

FOR ALL NANOSPOT MICRO ITEMS

AC098

FOR ALL NANOSPOT MINI ITEMS

AC099

FOR ALL NANOSPOT MEDIUM ITEMS

AC100 PIPE L 300 MM Extension pipe length 300 mm made in anodized aluminum with phospho-chromatised and polyester powder coating.

AC101 PIPE L 600 MM Extension pipe length 600 mm made in anodized aluminum with phospho-chromatised and polyester powder coating.

AC102 PIPE L 900 MM Extension pipe length 900 mm made in anodized aluminum with phospho-chromatised and polyester powder coating.



Remote Driver Selection for 101901 Nanospot Micro HP

Brand	Manufacturer code	Type	Watt	IP Rate	Number of fixtures
Meanwell	LPV-20-24	Constant voltage 24V DC	20W	IP67	min 1 - max 4
Meanwell	LPV-35-24	Constant voltage 24V DC	35W	IP67	min 1 - max 7
Meanwell	LPV-60-24	Constant voltage 24V DC	60W	IP67	min 1 - max 12

Remote Driver Selection for 101903 Nanospot Mini HP

Brand	Manufacturer code	Type	Watt	IP Rate	Number of fixtures
ALVIT Italy	AL1435S-IP	Constant current 350mA	14W	IP67	min 1 - max 2
ALVIT Italy	AL1450S-IP	Constant current 500mA	14W	IP67	1
ALVIT Italy	AL1470S-IP	Constant current 700mA	14W	IP67	1
TCI Italy	152014/350	Constant current 350mA	17W	IP68	min 1 - max 3
TCI Italy	152014/500	Constant current 500mA	24W	IP68	min 1 - max 3
TCI Italy	152014/700	Constant current 700mA	30W	IP68	min 1 - max 3

Remote Driver Selection for 101903RW Nanospot Mini RGBW

Brand	Manufacturer code	Type	Watt	IP Rate	Number of fixtures
Meanwell	LPV-20-24	Constant voltage 24C DV	20W	IP67	min 1 - max 3
Meanwell	LPV-35-24	Constant voltage 24C DV	35W	IP67	min 1 - max 6



Nanospot Steel

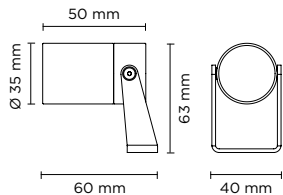

PRODUCT WEIGHT 0,80 kg



Code Example

102201 .27 .10 .SS .0

Accessories p. 64

Nanospot Micro Steel HP

Projector for outdoor installation on a façade/wall. Completely realized in stainless steel AISI 316L, tempered safety glass, moulded silicone gasket and stainless steel screws. Constant voltage 24V DC remote driver needed. With 1 x XP-G3 CREE LED. IP66 rating.

102201

3W

CCT	Beam Angle	lm	lm/w	Finish	Dimming
.27 2700°K	.10 10°	238	79.33	.SS Stainless Steel	.0 ON/OFF
	.30 30°	228	76.00		
	.45 45°	219	73.00		
.30 3000°K	.10 10°	250	83.33	.SS Stainless Steel	.0 ON/OFF
	.30 30°	240	80.00		
	.45 45°	230	76.66		
.40 4000°K	.10 10°	270	90.00	.SS Stainless Steel	.0 ON/OFF
	.30 30°	260	86.66		
	.45 45°	250	83.33		

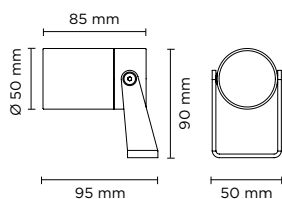

PRODUCT WEIGHT 1,10 kg



Code Example

102202 .30 .20 .SS .0

Accessories p. 64

Nanospot Mini Steel COB

Projector for outdoor installation on a façade/wall. Completely realized in stainless steel AISI 316L, tempered safety glass, moulded silicone gasket and stainless steel screws. With 1 direct 220-240V LUMENS "EDC 38C" COB LED. IP66 rating.

102202

4W

CCT	Beam Angle	lm	lm/w	Finish	Dimming
.30 3000°K	.20 20°	250	62.50	.SS Stainless Steel	.0 ON/OFF
	.40 40°	240	60.00		
.40 4000°K	.20 20°	260	65.00	.SS Stainless Steel	.0 ON/OFF
	.40 40°	250	62.50		

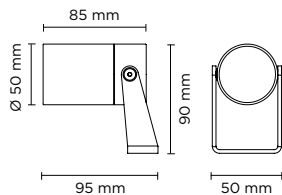

PRODUCT WEIGHT 1,10 kg



Code Example

102203.27.04.SS.0

Accessories p. 64

102203

Max 7W

Nanospot Mini Steel HP

Projector for outdoor installation on a façade/wall. Completely realized in stainless steel AISI 316L, tempered safety glass, moulded silicone gasket and stainless steel screws. Constant current max 500mA remote driver needed. With 1 x XHP35 CREE LED. IP66 rating.

CCT	Beam Angle	Finish	Dimming
.27 2700°K	.04 4°	.SS Stainless Steel	.0 ON/OFF
	.10 10°		
	.28 28°		
	.55 55°		
.30 3000°K	.04 4°	.SS Stainless Steel	.0 ON/OFF
	.10 10°		
	.28 28°		
	.55 55°		
.40 4000°K	.04 4°	.SS Stainless Steel	.0 ON/OFF
	.10 10°		
	.28 28°		
	.55 55°		

CCT	Beam Angle	350 mA LED POWER 5W		500 mA LED POWER 7W	
		lm	lm/w	lm	lm/w
2700°K	4°	485	96.90	656	93.64
	10°	465	92.91	629	89.84
	28°	450	90.06	609	87.12
	55°	383	76.57	519	74.10
3000°K	4°	510	102.00	690	98.57
	10°	489	97.80	662	94.57
	28°	474	94.80	642	91.71
	55°	403	80.58	546	77.95
4000°K	4°	520	104.00	703	100.43
	10°	499	99.80	676	96.57
	28°	484	96.80	656	93.71
	55°	411	82.28	558	76.65

Remote Driver Selection

Brand	Manufacturer code	Type	Watt	IP Rate	Number of fixtures
Meanwell	LPV-20-24	Constant Voltage 24V DC	20W	IP67	min 1 - max 3
Meanwell	LPV-35-24	Constant Voltage 24V DC	35W	IP67	min 1 - max 6

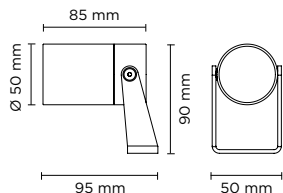

PRODUCT WEIGHT 1,10 kg

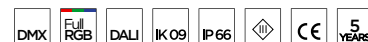

Code Example

102203.RW.12.SS.D

Accessories p. 64

Nanospot Mini Steel RGBW

Projector for outdoor installation on a façade/wall. Completely realised in stainless steel AISI 316L, tempered safety glass, moulded silicone gasket and stainless steel screws. Remote 24V DC power supply needed, remote DMX interface needed; with 1 x CREE "XML" RGBW LED. IP66 rating.

102203

4,5W

CCT	Beam Angle	lm	lm/w	Finish	Dimming
.RW RGBW	.12 12°	160	35.55	.SS Stainless Steel	.D DALI
	.25 25°	152	33.78		.X DMX
	.35 35°	145	32.23		

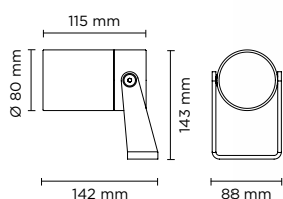

PRODUCT WEIGHT 2,30 kg



Code Example

102204.30.20.SS.O

Accessories p. 64

Nanospot Medium Steel COB

Projector for outdoor installation on a façade/wall. Completely realised in stainless steel AISI 316L, tempered safety glass, moulded silicone gasket and stainless steel screws. With 1 direct 220-240V LUMENS "EDC 47C" COB LED. IP66 rating.

102204

10W

CCT	Beam Angle	lm	lm/w	Finish	Dimming
.30 3000°K	.20 20°	700	70.00	.SS Stainless Steel	.O ON/OFF
	.40 40°	690	69.00		
.40 4000°K	.20 20°	735	73.50		
	.40 40°	720	72.00		

INTEGRATED ACCESSORIES

102201.27.10.SS.0. _ _ _

Built-in accessories to be requested when ordering
example 101201.27.10.SS.0.HC

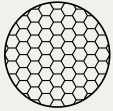

.HC

HONEYCOMB

A honeycomb structure designed to shield the light beam, reduce glare, and eliminate direct exposure to the light source. **Compatible for all products of the series.**

ACCESSORIES NOT INCLUDED

Accessories to be ordered separately.



AC044

SPIKE

Ground-mounted installation accessory. **Compatible for all products of the series.**



GLARE SHIELD

Minimizes glare and optimizes beam direction for precise lighting.

Available for:

AC126

FOR ALL NANOSPOT STEEL **MICRO** ITEMS

AC127

FOR ALL NANOSPOT STEEL **MINI** ITEMS

AC128

FOR ALL NANOSPOT STEEL **MEDIUM** ITEMS



AC038

TREE STRAP

Fastening system for securing lighting fixtures to trees. **Compatible for all products of the series.**

PRODUCT FINISH DETAIL

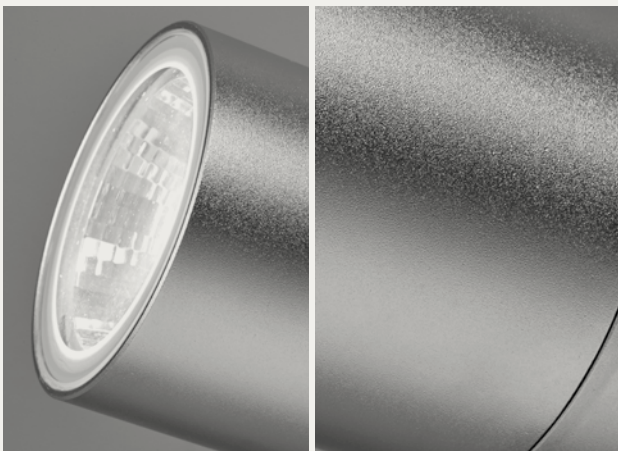



IN
GRO
UND





Terra Mini

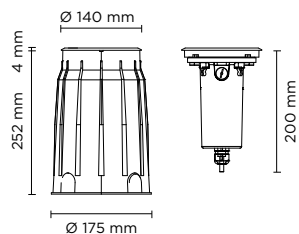

PRODUCT WEIGHT 2,70 kg



Code Example

207001.27.18.SS.0

Accessories p. 71

Terra Mini COB

Diameter 140mm ground-recessed luminaire for outdoor installation, phospho-chromatised and polyester powder coated die-cast copper-free aluminium body and stainless steel AISI 316L frame, tempered safety glass, moulded silicone gasket. Light source tilt system +/- 15deg from outside. Built-in LED driver 220-240V 50-60Hz, with 1 CREE CXB1304 LED. IP67 rating.

207001

8W

CCT	Beam Angle	lm	lm/w
.27 2700°K	.18 18°	600	75.00
	.36 36°	580	72.50
	.60 60°	560	70.00
.30 3000°K	.18 18°	620	77.50
	.36 36°	600	75.00
	.60 60°	580	72.50
.40 4000°K	.18 18°	640	80.00
	.36 36°	620	77.50
	.60 60°	600	75.00

Finish

.SS  Stainless Steel

Dimming

.0 ON/OFF

.D DALI

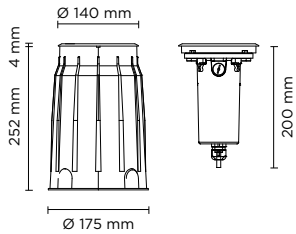

PRODUCT WEIGHT 2,70 kg

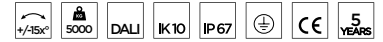

Code Example

207002.27.04.SS.0

Accessories p. 71

Terra Mini HP

Diameter 140mm ground-recessed luminaire for outdoor installation, phospho-chromatised and polyester powder coated die-cast copper-free aluminium body and stainless steel AISI 316L frame, tempered safety glass, moulded silicone gasket. Light source tilt system +/- 15deg from outside. Built-in LED driver 220-240V 50-60Hz, with 1 CREE "XHP35" LED. IP67 rating.

207002

8W

CCT	Beam Angle	lm	lm/w	Finish	Dimming
.27 2700°K	.04 4°	670	83.75	.SS Stainless Steel	.0 ON/OFF .D DALI
	.10 10°	642	80.25		
	.28 28°	622	77.75		
	.55 55°	529	65.92		
.30 3000°K	.04 4°	690	86.25	.SS Stainless Steel	.0 ON/OFF .D DALI
	.10 10°	662	82.75		
	.28 28°	642	80.25		
	.55 55°	546	68.21		
.40 4000°K	.04 4°	703	87.88	.SS Stainless Steel	.0 ON/OFF .D DALI
	.10 10°	676	84.50		
	.28 28°	656	82.00		
	.55 55°	558	69.70		

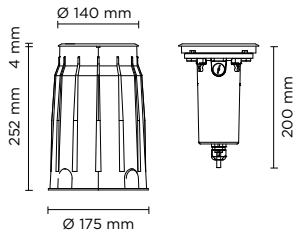

PRODUCT WEIGHT 2,70 kg



Code Example

207003.RW.12.SS.D

Accessories p. 71

Terra Mini HP DMX RGBW

Diameter 140mm ground-recessed luminaire for outdoor installation, phospho-chromatised and polyester powder coated die-cast copper-free aluminium body and stainless steel AISI 316L frame, tempered safety glass, moulded silicone gasket. Light source tilt system +/- 15deg from outside. Remote 24V DC power supply needed, DMX interface integrated; with 1 x CREE "XML" RGBW LED. IP67 rating.

207003

4,5W

CCT	Beam Angle	lm	lm/w	Finish	Dimming
.RW RGBW	.12 12°	160	35.55	.SS Stainless Steel	.D DALI .X DMX
	.25 25°	152	33.78		
	.35 35°	145	32.23		

Remote Driver Selection

Brand	Manufacturer code	Type	Watt	IP Rate	Number of fixtures
Meanwell	LPV-20-24	constant voltage 24V DC	20W	IP67	min 1 - max 3
Meanwell	LPV-35-24	constant voltage 24V DC	35W	IP67	min 1 - max 6

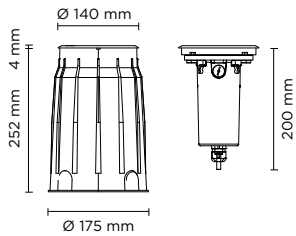

PRODUCT WEIGHT 2,70 kg



Code Example

207004 · 27 · DF · SS · 0

Accessories p. 71

Terra Mini Diffused

Diameter 140mm ground-recessed luminaire for outdoor installation, phospho-chromatised and polyester powder coated die-cast copper-free aluminium body and stainless steel AISI 316L frame, tempered safety glass, moulded silicone gasket. Built-in LED driver 220-240V 50-60Hz, with 16 x mid-power SAMSUNG 2835 LED. IP67 rating.

207004
6W

CCT	Beam Angle	lm	lm/w
.27 2700°K	.DF Diffused	100	16.67
.30 3000°K	.DF Diffused	110	18.34
.40 4000°K	.DF Diffused	120	20.00

Finish	Dimming
.SS Stainless Steel	.0 ON/OFF .D DALI

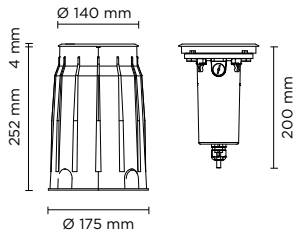

PRODUCT WEIGHT 2,70 kg



Code Example

207005 · 27 · WW · SS · 0

Accessories p. 71

Terra Mini Wall-Washer

Diameter 140mm ground-recessed luminaire for outdoor installation, phospho-chromatised and polyester powder coated die-cast copper-free aluminium body and stainless steel AISI 316L frame, tempered safety glass, moulded silicone gasket. Built-in LED driver 220-240V 50-60Hz, with 16 x mid-power SAMSUNG 2835 LED. IP67 rating.

207005
6W

CCT	Beam Angle	lm	lm/w
.27 2700°K	.WW Wall Washer	450	75.00
.30 3000°K	.WW Wall Washer	470	78.34
.40 4000°K	.WW Wall Washer	490	81.67

Finish	Dimming
.SS Stainless Steel	.0 ON/OFF .D DALI

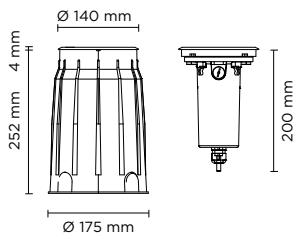

PRODUCT WEIGHT 2,70 kg



Code Example

207006 · 27 · BL · SS · 0

Accessories p. 71

Terra Mini Blade

Diameter 140mm ground-recessed luminaire for outdoor installation, phospho-chromatised and polyester powder coated die-cast copper-free aluminium body and stainless steel AISI 316L frame, tempered safety glass, moulded silicone gasket. Built-in LED driver 220-240V 50-60Hz, with 1 CREE "XHP35" LED. IP67 rating.

207006
8W

CCT	Beam Angle	lm	lm/w
.27 2700°K	.BL 8°x170°	560	70.00
.30 3000°K	.BL 8°x170°	582	72.75
.40 4000°K	.BL 8°x170°	600	75.00

Finish	Dimming
.SS Stainless Steel	.0 ON/OFF .D DALI

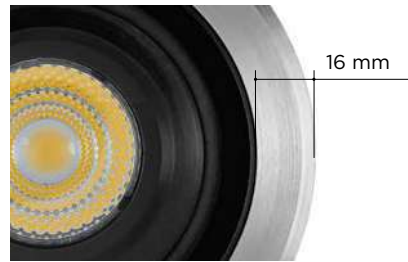
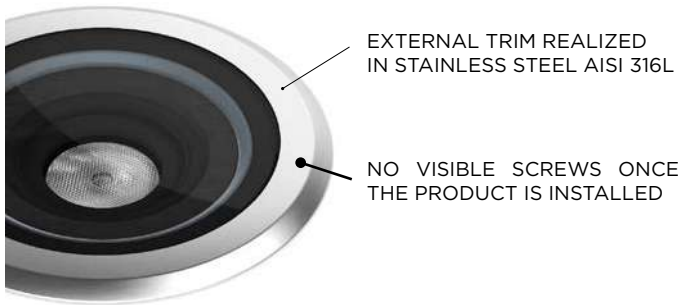

REDUCED WIDTH AT 16 MM FOR BETTER AESTHETIC IMPACT



SPECIAL TILT SYSTEM INTEGRATED ALLOWING ON SITE ADJUSTMENT +/- 15 DEG. WITHOUT OPENING THE LUMINAIRE



LIGHTING FIXTURE WITH DEDICATED RECESSED HOUSING FOR IN-GROUND INSTALLATION, ENSURING CORRECT POSITIONING, STRUCTURAL STABILITY, AND PROTECTION

LIGHT BEAM OPTIONS

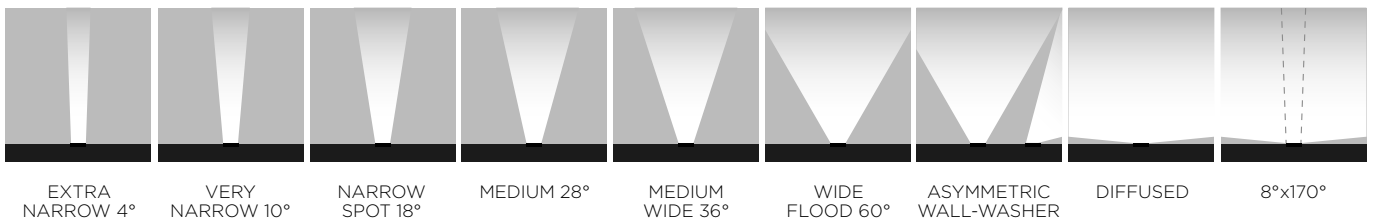

INTEGRATED ACCESSORIES

207001.27.18.SS.0. _ _

Built-in accessories to be requested when ordering
example 207001.27.18.SS.0.HC



.HC

HONEYCOMB

A honeycomb structure designed to shield the light beam, reduce glare, and eliminate direct exposure to the light source. Available for:

- TERRA MINI COB
- TERRA MINI HP
- TERRA MINI HP DMX RGBW



.GS

GLARE SHIELD

Glare shield accessory made in hard anodized black aluminum, for applications requiring very reduced glaring; minimal light loss on the light surface but overall lumen output typically reduced by 50%. Available for:

- TERRA MINI COB
- TERRA MINI HP
- TERRA MINI HP DMX RGBW

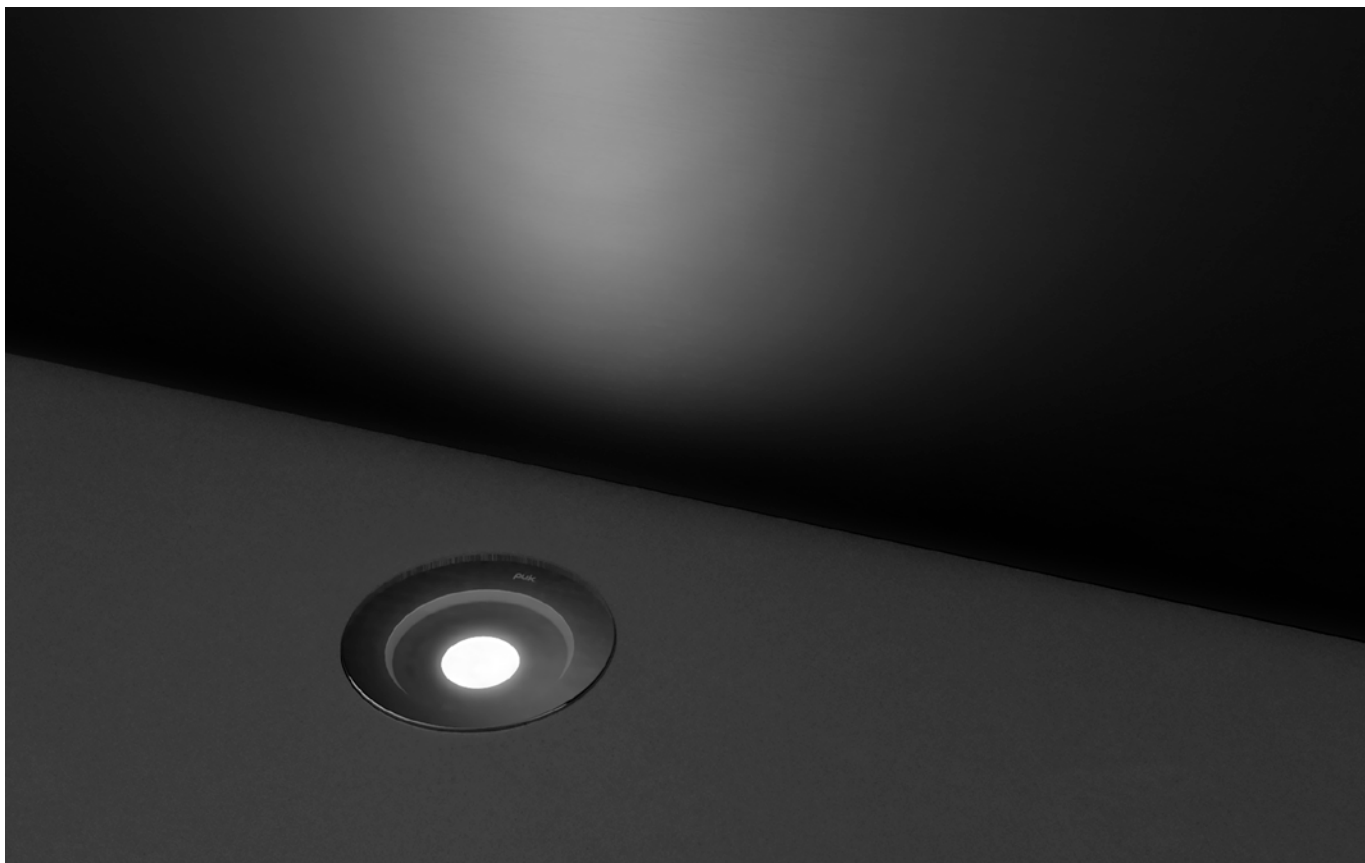

Terra Mini Trimless

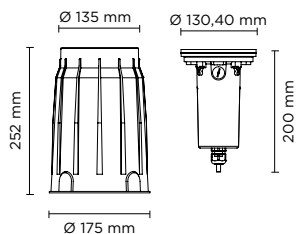

PRODUCT WEIGHT 2,70 kg



Code Example

207007.**27**.**18**.**GL**.**0**

Accessories p. 75

Terra Mini Trimless COB

Diameter 130mm ground-recessed luminaire for outdoor installation, phospho-chromatised and polyester powder coated die-cast copper-free aluminium body, tempered safety glass, moulded silicone gasket. Light source tilt system +/- 15deg from outside.

Built-in LED driver 220-240V 50-60Hz, with 1 CREE CXB1304 LED. IP67 rating.

207007

8W

CCT	Beam Angle	lm	lm/w	Finish	Dimming
.27 2700°K	.18 18°	600	75.00	.GL <input type="checkbox"/> Glass	.0 ON/OFF .D DALI
	.36 36°	580	72.50		
	.60 60°	560	70.00		
.30 3000°K	.18 18°	620	77.50	.GL <input type="checkbox"/> Glass	.0 ON/OFF .D DALI
	.36 36°	600	75.00		
	.60 60°	580	72.50		
.40 4000°K	.18 18°	640	80.00	.GL <input type="checkbox"/> Glass	.0 ON/OFF .D DALI
	.36 36°	620	77.50		
	.60 60°	600	75.00		

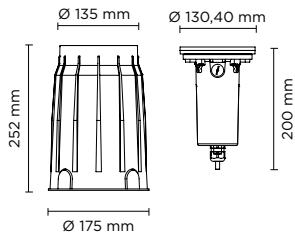

PRODUCT WEIGHT 2,70 kg



Code Example

207008.27.04.GL.0

Accessories p. 75

Terra Mini Trimless HP

Diameter 130mm ground-recessed luminaire for outdoor installation, phospho-chromatised and polyester powder coated die-cast copper-free aluminium body, tempered safety glass, moulded silicone gasket. Light source tilt system +/- 15deg from outside.

Built-in LED driver 220-240V 50-60Hz, with 1 CREE "XHP35" LED. IP67 rating.

207008

8W

CCT	Beam Angle	lm	lm/w	Finish	Dimming
.27 2700°K	.04 4°	670	83.75	.GL <input type="checkbox"/> Glass	.0 ON/OFF
	.10 10°	642	80.25		.D DALI
	.28 28°	622	77.75		
	.55 55°	529	65.92		
.30 3000°K	.04 4°	690	86.25		
	.10 10°	662	82.75		
	.28 28°	642	80.25		
	.55 55°	546	68.21		
.40 4000°K	.04 4°	703	87.88		
	.10 10°	676	84.50		
	.28 28°	656	82.00		
	.55 55°	558	69.70		

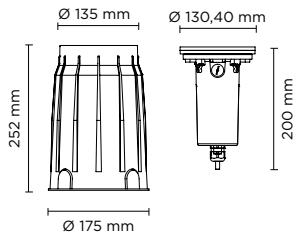

PRODUCT WEIGHT 2,70 kg



Code Example

207009.RW.12.GL.D

Accessories p. 75

Terra Mini Trimless HP DMX RGBW

Diameter 130mm ground-recessed luminaire for outdoor installation, phospho-chromatised and polyester powder coated die-cast copper-free aluminium body and stainless steel AISI 316L frame, tempered safety glass, moulded silicone gasket. Light source tilt system +/- 15deg from outside.

Remote 24V DC power supply needed, DMX interface integrated; with 1 x CREE "XML" RGBW LED. IP67 rating.

207009

4,5W

CCT	Beam Angle	lm	lm/w	Finish	Dimming
.RW RGBW	.12 12°	160	35.55	.GL <input type="checkbox"/> Glass	.D DALI
	.25 25°	152	33.78		.X DMX
	.35 35°	145	32.23		

Remote Driver Selection

Brand	Manufacturer code	Type	Watt	IP Rate	Number of fixtures
Meanwell	LPV-20-24	constant voltage 24V DC	20W	IP67	min 1 - max 3
Meanwell	LPV-35-24	constant voltage 24V DC	35W	IP67	min 1 - max 6

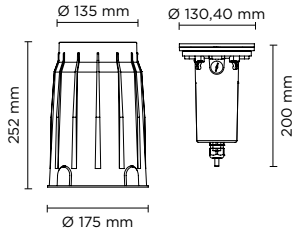

PRODUCT WEIGHT 2,70 kg



Code Example

207010 .27 .DF .GL .0

Accessories p. 75

Terra Mini Trimless Diffused

Diameter 130mm ground-recessed luminaire for outdoor installation, phospho-chromatised and polyester powder coated die-cast copper-free aluminium body, tempered safety glass, moulded silicone gasket. Built-in LED driver 220-240V 50-60Hz, , with 16 x mid-power SAMSUNG 2835 LED. IP67 rating.

CCT	Beam Angle	Im	lm/w	Finish	Dimming	
207010 6W	.27 2700°K	.DF Diffused	100	16.67	.OP <input type="checkbox"/> Opal	.0 ON/OFF .D DALI
	.30 3000°K	.DF Diffused	110	18.34		
	.40 4000°K	.DF Diffused	120	20.00		

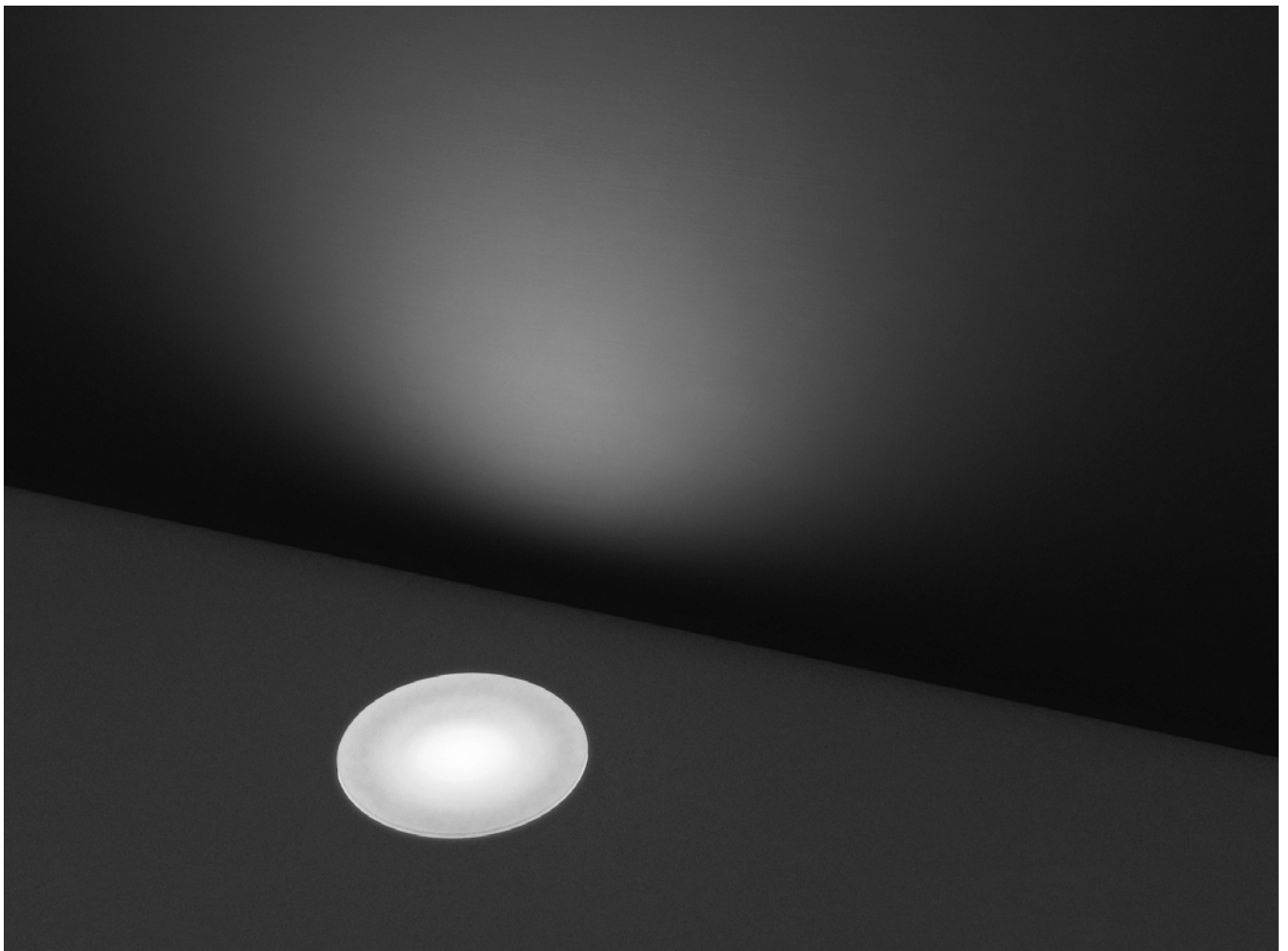



SPECIAL TILT SYSTEM INTEGRATED
 ALLOWING ON SITE ADJUSTMENT
 +/- 15 DEG. WITHOUT OPENING
 THE LUMINAIRE

LIGHT BEAM OPTIONS



EXTRA
 NARROW 4°

VERY
 NARROW 10°

NARROW
 SPOT 18°

MEDIUM 28°

MEDIUM
 WIDE 36°

WIDE
 FLOOD 60°

DIFFUSED

INTEGRATED ACCESSORIES

207007.27.18.GL.0. _ _

Built-in accessories to be requested when ordering
 example 207007.27.18.GL.0.HC



.HC

HONEYCOMB

A honeycomb structure designed to shield the light beam, reduce glare, and eliminate direct exposure to the light source.

Available for:

- TERRA MINI TRIMLESS COB
- TERRA MINI TRIMLESS HP
- TERRA MINI TRIMLESS HP DMX RGBW



.GS

GLARE SHIELD

Glare shield accessory made in hard anodized black aluminum, for applications requiring very reduced glaring; minimal light loss on the light surface but overall lumen output typically reduced by 50%.

Available for:

- TERRA MINI TRIMLESS COB
- TERRA MINI TRIMLESS HP
- TERRA MINI TRIMLESS HP DMX RGBW



Terra Medium

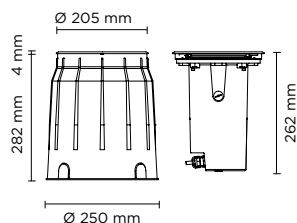

PRODUCT WEIGHT 5,40 kg



Code Example

207011.27.14.SS.0

Accessories p. 79

Terra Medium COB

Diameter 205mm ground-recessed luminaire for outdoor installation, phospho-chromatised and polyester powder coated die-cast copper-free aluminium body and stainless steel AISI 316L frame, tempered safety glass, moulded silicone gasket. Light source tilt system +/- 15deg from outside. Built-in LED driver 220-240V 50-60Hz, with 1 CREE CXB1512 LED. IP67 rating.

207011
13W

CCT	Beam Angle	lm	lm/w
.27 2700°K	.14 14°	1.050	80.77
	.35 35°	1.000	76.93
	.55 55°	980	75.38
.30 3000°K	.14 14°	1.099	84.54
	.35 35°	1.079	83.00
	.55 55°	1.057	81.31
.40 4000°K	.14 14°	1.133	87.15
	.35 35°	1.113	85.62
	.55 55°	1.090	83.85

Finish

.SS Stainless Steel

Dimming

.0 ON/OFF
.D DALI

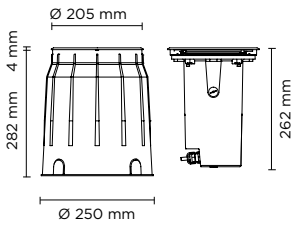

PRODUCT WEIGHT 5,40 kg

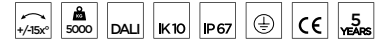

Code Example

207012 .27 .04 .SS .0

Accessories p. 79

Terra Medium HP

Diameter 205mm ground-recessed luminaire for outdoor installation, phospho-chromatised and polyester powder coated die-cast copper-free aluminium body and stainless steel AISI 316L frame, tempered safety glass, moulded silicone gasket. Light source tilt system +/- 15deg from outside. Built-in LED driver, with 3 x CREE "XHP35" LED. IP67 rating.

207012

20W

CCT	Beam Angle	lm	lm/w	Finish	Dimming
.27 2700°K	.04 4°	1.809	90.45	.SS Stainless Steel	.0 ON/OFF .D DALI
	.10 10°	1.733	86.65		
	.28 28°	1.679	83.95		
	.55 55°	1.427	71.36		
.30 3000°K	.04 4°	1.863	93.15	.SS Stainless Steel	.0 ON/OFF .D DALI
	.10 10°	1.787	89.35		
	.28 28°	1.733	86.65		
	.55 55°	1.473	73.65		
.40 4000°K	.04 4°	1.898	94.90	.SS Stainless Steel	.0 ON/OFF .D DALI
	.10 10°	1.825	91.25		
	.28 28°	1.771	88.55		
	.55 55°	1.505	75.27		

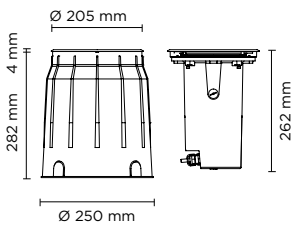

PRODUCT WEIGHT 5,40 kg



Code Example

207013 .RW .12 .SS .D

Accessories p. 79

Terra Medium HP DMX RGBW

Diameter 205mm ground-recessed luminaire for outdoor installation, phospho-chromatised and polyester powder coated die-cast copper-free aluminium body and stainless steel AISI 316L frame, tempered safety glass, moulded silicone gasket. Light source tilt system +/- 15deg from outside. Built-in LED driver, DMX interface integrated; with 3 x CREE "XML" RGBW LED. IP67 rating.

207013

14W

CCT	Beam Angle	lm	lm/w	Finish	Dimming
.RW RGBW	.12 12°	480	34.28	.SS Stainless Steel	.D DALI .X DMX
	.25 25°	456	32.58		
	.35 35°	435	31.07		

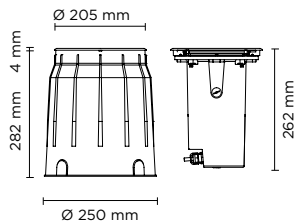

PRODUCT WEIGHT 5,40 kg



Terra Medium Wall-Washer

Diameter 205mm ground-recessed luminaire for outdoor installation, phospho-chromatised and polyester powder coated die-cast copper-free aluminium body and stainless steel AISI 316L frame, tempered safety glass, moulded silicone gasket. Built-in LED driver 220-240V 50-60Hz, with 32 x mid-power SAMSUNG 2835 LED. IP67 rating.

Code Example

207014·.27·WW·SS·0

Accessories p. 79

CCT	Beam Angle	Im	Im/w	Finish	Dimming
207014 13W	.27 2700°K .WW Wall Washer	900	69.23	.SS Stainless Steel	.0 ON/OFF .D DALI
	.30 3000°K .WW Wall Washer	940	72.31		
	.40 4000°K .WW Wall Washer	980	75.38		



PRODUCT OVERVIEW

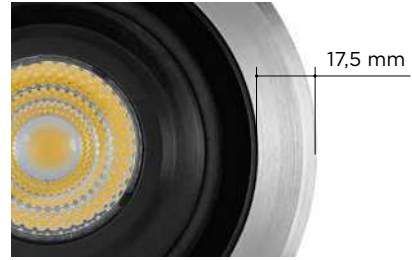
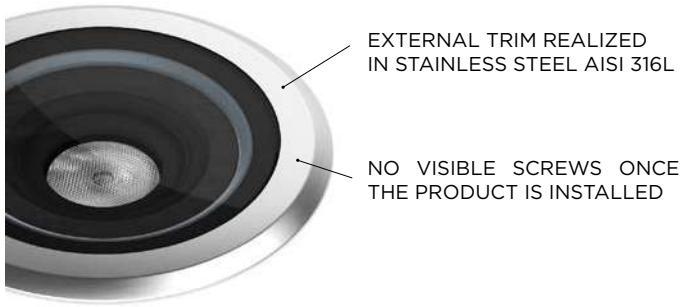

REDUCED WIDTH AT 17,5 MM FOR BETTER AESTHETIC IMPACT



SPECIAL TILT SYSTEM INTEGRATED ALLOWING ON SITE ADJUSTMENT +/- 15 DEG. WITHOUT OPENING THE LUMINAIRE



LIGHTING FIXTURE WITH DEDICATED RECESSED HOUSING FOR IN-GROUND INSTALLATION, ENSURING CORRECT POSITIONING, STRUCTURAL STABILITY, AND PROTECTION

LIGHT BEAM OPTIONS



EXTRA NARROW 4°

VERY NARROW 10°

NARROW SPOT 14°

MEDIUM 28°

MEDIUM WIDE 35°

WIDE FLOOD 55°

ASYMMETRIC WALL-WASHER

INTEGRATED ACCESSORIES

207011.27.14.SS.O. _ _

Built-in accessories to be requested when ordering
example 207011.27.14.SS.O.HC



.HC

HONEYCOMB

A honeycomb structure designed to shield the light beam, reduce glare, and eliminate direct exposure to the light source.

Available for:

- TERRA MEDIUM COB
- TERRA MEDIUM HP
- TERRA MEDIUM HP DMX RGBW



Terra Maxi

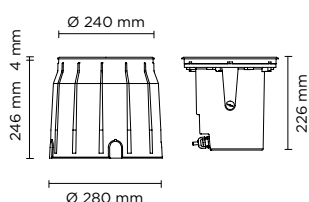

PRODUCT WEIGHT 6,50 kg



Code Example

207015 .27 .14 .SS .0

Accessories p. 83

Terra Maxi COB

Diameter 240mm ground-recessed luminaire for outdoor installation, phospho-chromatised and polyester powder coated die-cast copper-free aluminium body and stainless steel AISI 316L frame, tempered safety glass, moulded silicone gasket. Light source tilt system +/- 15deg from outside. Built-in LED driver 220-240V 50-60Hz, with 1 CREE CXB2540 LED. IP67 rating.

207015
32W

CCT	Beam Angle	lm	lm/w
.27 2700°K	.14 14°	2.960	92.50
	.35 35°	2.940	91.88
	.55 55°	2.920	91.25
.30 3000°K	.14 14°	2.970	92.81
	.35 35°	2.950	92.19
	.55 55°	2.930	91.56
.40 4000°K	.14 14°	2.990	93.44
	.35 35°	2.970	92.81
	.55 55°	2.950	92.19

Finish

.SS Stainless Steel

Dimming

.0 ON/OFF
.D DALI

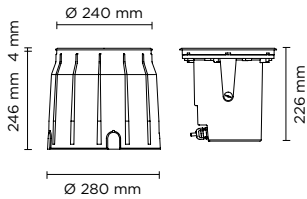

PRODUCT WEIGHT 6,50 kg



Code Example

207016 · .27 · .04 · .SS · .0

Accessories p. 83

Terra Maxi HP

Diameter 240mm ground-recessed luminaire for outdoor installation, phospho-chromatised and polyester powder coated die-cast copper-free aluminium body and stainless steel AISI 316L frame, tempered safety glass, moulded silicone gasket. Light source tilt system +/- 15deg from outside. Built-in LED driver, with 4 x CREE "XHP50.2" LED. IP67 rating.

207016
34W

CCT	Beam Angle	lm	lm/w	Finish	Dimming
.27 2700°K	.04 4°	3.296	96.94	.SS Stainless Steel	.0 ON/OFF .D DALI
	.10 10°	3.268	96.12		
	.28 28°	3.239	95.26		
.30 3000°K	.04 4°	3.325	97.79	.SS Stainless Steel	.0 ON/OFF .D DALI
	.10 10°	3.296	96.94		
	.28 28°	3.268	96.12		
.40 4000°K	.04 4°	3.353	98.62	.SS Stainless Steel	.0 ON/OFF .D DALI
	.10 10°	3.325	97.79		
	.28 28°	3.296	96.94		
	.55 55°	2.802	82.40		

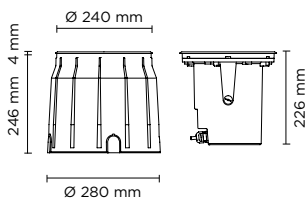

PRODUCT WEIGHT 6,50 kg



Code Example

207017 · .RW · .12 · .SS · .D

Accessories p. 83

Terra Maxi HP DMX RGBW

Diameter 240mm ground-recessed luminaire for outdoor installation, phospho-chromatised and polyester powder coated die-cast copper-free aluminium body and stainless steel AISI 316L frame, tempered safety glass, moulded silicone gasket. Light source tilt system +/- 15deg from outside. Built-in LED driver, DMX interface integrated; with 6 x CREE "XML" RGBW LED. IP67 rating.

207017
28W

CCT	Beam Angle	lm	lm/w	Finish	Dimming
.RW RGBW	.12 12°	1.000	35.71	.SS Stainless Steel	.D DALI .X DMX
	.25 25°	992	35.43		
	.35 35°	981	35.04		

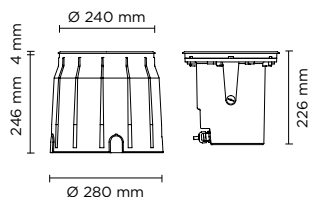

PRODUCT WEIGHT 6,50 kg



Code Example

207018·.27·WW·SS·.0

Accessories p. 83

Terra Maxi Wall-Washer

Diameter 240mm ground-recessed luminaire for outdoor installation, phospho-chromatised and polyester powder coated die-cast copper-free aluminium body and stainless steel AISI 316L frame, tempered safety glass, moulded silicone gasket. Built-in LED driver 220-240V 50-60Hz, with 66 x mid-power SAMSUNG 2835 LED. IP67 rating.

CCT	Beam Angle	Im	Im/w	Finish	Dimming
207018 24W	.27 2700°K .WW Wall Washer	1.800	75.00	.SS Stainless Steel	.0 ON/OFF
	.30 3000°K .WW Wall Washer	1.880	78.33		.D DALI
	.40 4000°K .WW Wall Washer	1.960	81.67		

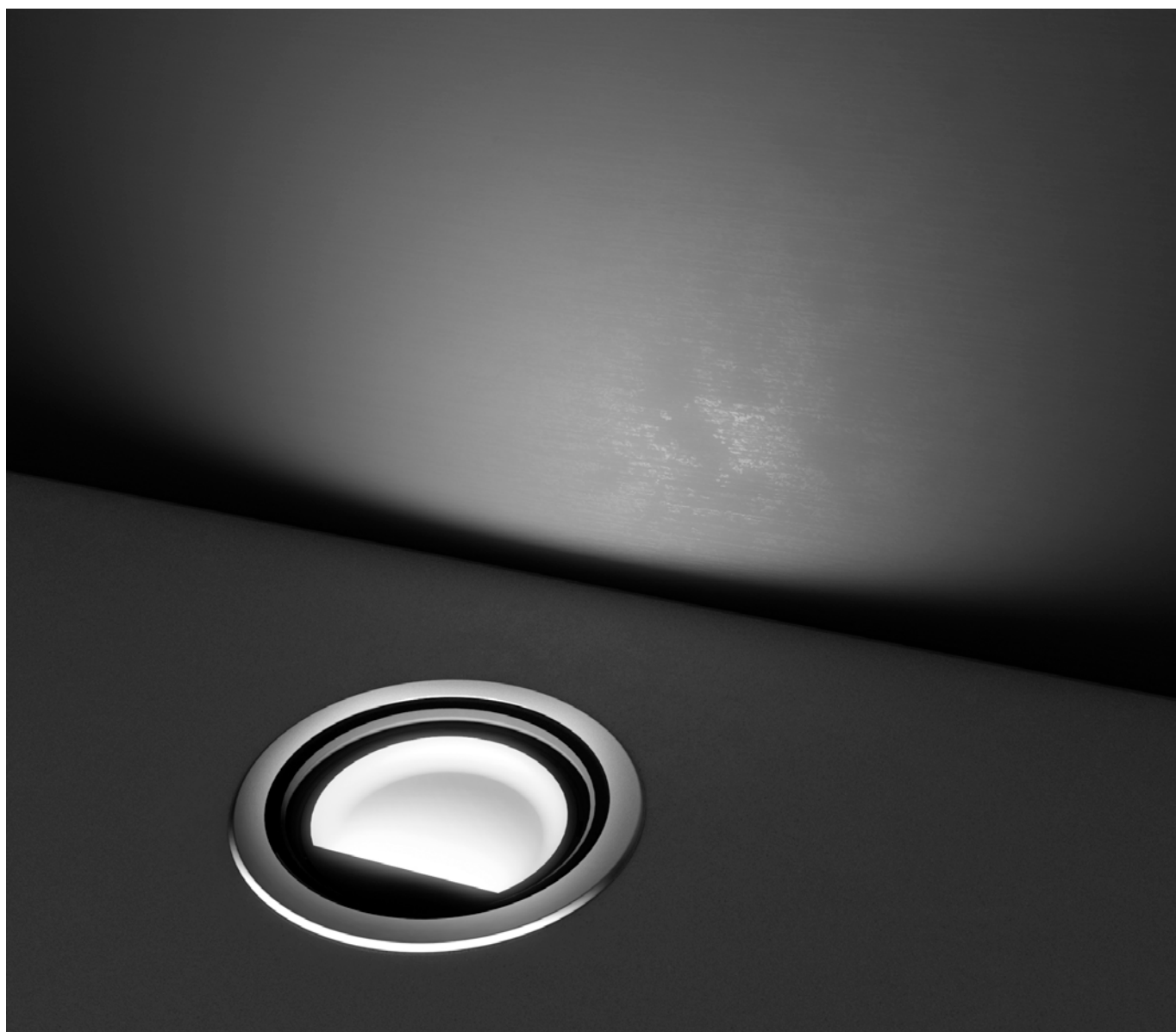

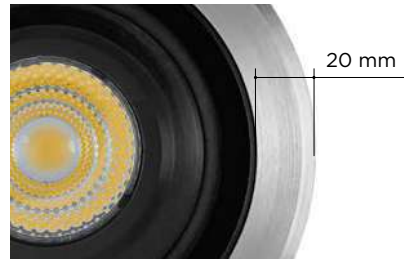
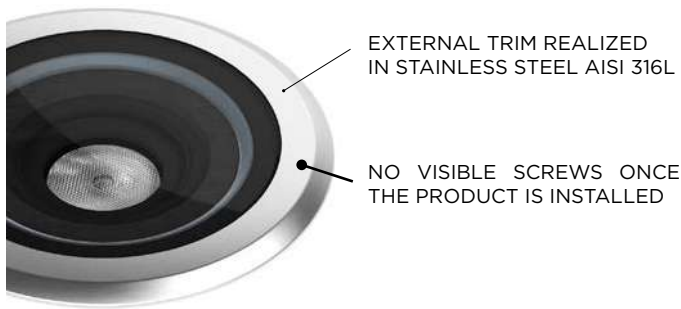

REDUCED WIDTH AT 20 MM FOR BETTER AESTHETIC IMPACT



SPECIAL TILT SYSTEM INTEGRATED ALLOWING ON SITE ADJUSTMENT +/- 15 DEG. WITHOUT OPENING THE LUMINAIRE



LIGHTING FIXTURE WITH DEDICATED RECESSED HOUSING FOR IN-GROUND INSTALLATION, ENSURING CORRECT POSITIONING, STRUCTURAL STABILITY, AND PROTECTION

LIGHT BEAM OPTIONS



EXTRA NARROW 4°

VERY NARROW 10°

NARROW SPOT 14°

MEDIUM 28°

MEDIUM WIDE 35°

WIDE FLOOD 55°

ASYMMETRIC WALL-WASHER

INTEGRATED ACCESSORIES

207015.27.14.SS.0. _ _ _

Built-in accessories to be requested when ordering
example 207015.27.14.SS.0.HC



.HC

HONEYCOMB

A honeycomb structure designed to shield the light beam, reduce glare, and eliminate direct exposure to the light source.

Available for:

- TERRA **MAXI COB**
- TERRA **MAXI HP**
- TERRA **MAXI HP DMX RGBW**

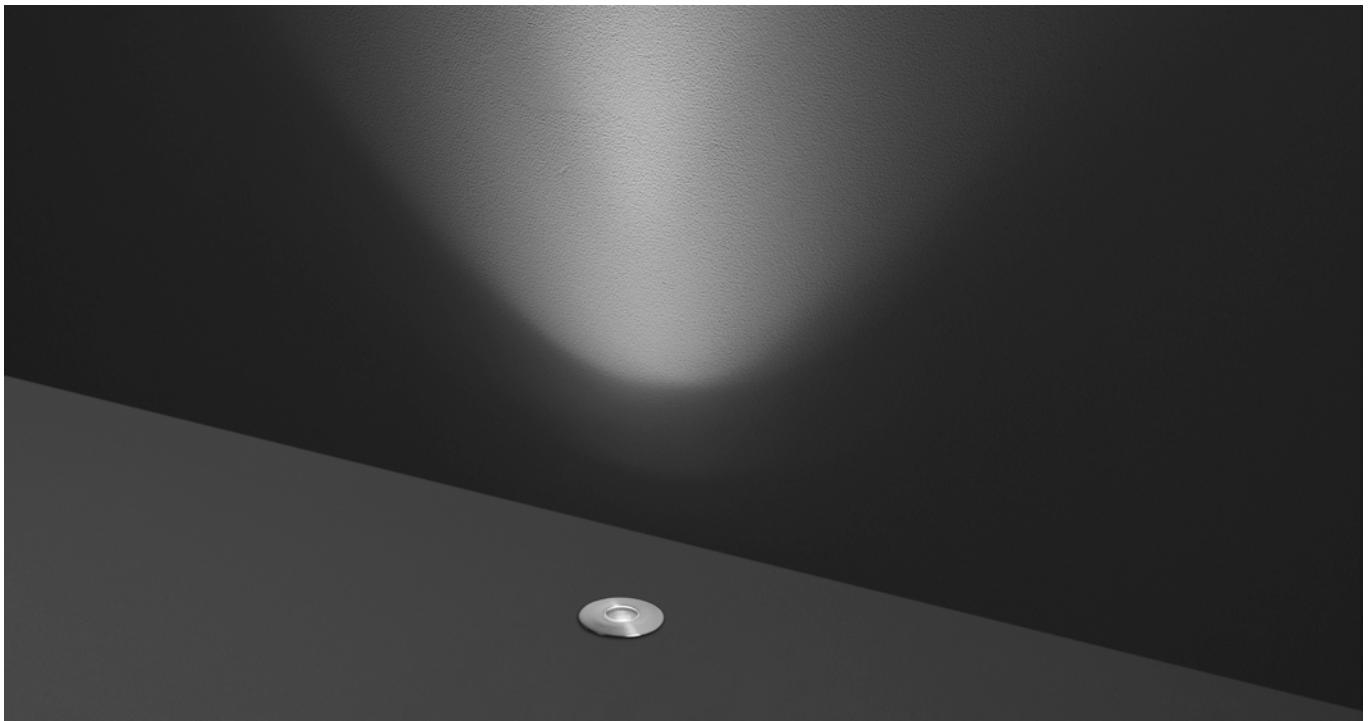

Hydrofloor



PRODUCT WEIGHT 0,20 kg



Code Example

201074, .27, .15, .SS, .0

Accessories p. 90

Hydrofloor Nano XXS

Round ground-recessed luminaire for outdoor installation, Hard anodized black aluminium body and stainless steel AISI 316 front trim, tempered safety glass, moulded silicone gasket. Remote constant current 350 mA driver needed, with 1 CREE XP-G2 LED. IP68 rating.

201074

1W

CCT	Beam Angle	lm	lm/w	Finish	Dimming
.27 2700°K	.15 15°	71	71.00	.SS Stainless Steel	.0 ON/OFF
	.30 30°	62	62.00		
	.45 45°	57	57.00		
.30 3000°K	.15 15°	75	75.00	.SS Stainless Steel	.0 ON/OFF
	.30 30°	65	65.00		
	.45 45°	60	60.00		
.40 4000°K	.15 15°	80	80.00	.SS Stainless Steel	.0 ON/OFF
	.30 30°	70	70.00		
	.45 45°	65	65.00		

Remote Driver Selection

Brand	Manufacturer code	Type	Watt	IP Rate	Number of fixtures
ALVIT Italy	AL1435S-IP	constant current 350mA	14W	IP67	min 1 - max 8
Meanwell	LPC-20-350	constant current 350mA	16.8W	IP67	min 4 - max 12

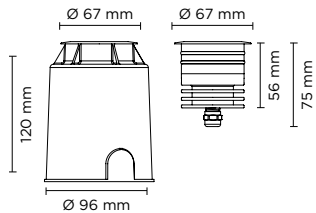

PRODUCT WEIGHT 0,70 kg



Hydrofloor Nano XS

Code Example

201072.**27**.**10**.**SS**.**0**

Accessories p. 90

Round ground-recessed luminaire for outdoor installation, Hard anodized black aluminium body and stainless steel AISI 316 front trim, tempered safety glass, moulded silicone gasket. Remote constant current max 700 mA driver needed, with 1 CREE XP-L LED. IP68 rating.

201072
Max 2,5W

CCT	Beam Angle	Finish	Dimming
.27 2700°K	.10 10°	.SS Stainless Steel	.0 ON/OFF
	.30 30°		
	.45 45°		
.30 3000°K	.10 10°	.SS Stainless Steel	.0 ON/OFF
	.30 30°		
	.45 45°		
.40 4000°K	.10 10°	.SS Stainless Steel	.0 ON/OFF
	.30 30°		
	.45 45°		

CCT	Beam Angle	350 mA LED POWER 1.2W		500 mA LED POWER 1.7W		700 mA LED POWER 2.5W	
		lm	lm/w	lm	lm/w	lm	lm/w
2700°K	10°	131	109.00	186	109.00	274	109.00
	30°	124	103.00	178	105.00	261	104.00
	45°	118	98.00	168	99.00	247	99.00
3000°K	10°	138	115.00	196	115.00	288	115.00
	30°	132	110.00	187	110.00	275	110.00
	45°	125	104.00	177	104.00	260	104.00
4000°K	10°	144	120.00	204	120.00	300	120.00
	30°	137	114.00	194	114.00	285	114.00
	45°	131	109.00	186	109.00	273	109.00

Remote Driver Selection

Brand	Manufacturer code	Type	Watt	IP Rate	Number of fixtures
ALVIT Italy	AL1435S-IP	constant current 350mA	14W	IP67	min 1 - max 8
ALVIT Italy	AL1450S-IP	constant current 500mA	14W	IP67	min 1 - max 6
ALVIT Italy	AL1470S-IP	constant current 700mA	14W	IP67	min 1 - max 4

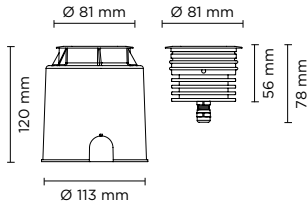

PRODUCT WEIGHT 0,90 kg



Hydrofloor Nano

Round ground-recessed luminaire for outdoor installation, Hard anodized black aluminium body and stainless steel AISI 316 front trim, tempered safety glass, moulded silicone gasket. Remote constant current max 700 mA driver needed, with 1 CREE XHP35 HD LED. IP68 rating.

Code Example

201073.**J**.**27**.**J**.**04**.**J**.**SS**.**0**

Accessories p. 90

201073

Max 10W

CCT	Beam Angle	Finish	Dimming
.27 2700°K	.04 4°	.SS Stainless Steel	.0 ON/OFF
	.10 10°		
	.28 28°		
	.55 55°		
.30 3000°K	.04 4°	.SS Stainless Steel	.0 ON/OFF
	.10 10°		
	.28 28°		
	.55 55°		
.40 4000°K	.04 4°	.SS Stainless Steel	.0 ON/OFF
	.10 10°		
	.28 28°		
	.55 55°		

CCT	Beam Angle	350 mA LED POWER 5W		500 mA LED POWER 7W		700 mA LED POWER 10W	
		lm	lm/w	lm	lm/w	lm	lm/w
2700°K	4°	485	97.00	656	93.71	862	86.20
	10°	465	93.00	629	89.86	828	82.80
	28°	450	90.00	610	87.14	804	80.40
	55°	383	76.60	519	74.14	683	68.30
3000°K	4°	510	102.00	690	98.57	907	90.69
	10°	489	97.80	662	94.57	872	87.20
	28°	474	94.80	642	91.71	846	84.60
	55°	403	80.58	546	77.95	719	71.91
4000°K	4°	520	104.00	703	100.43	930	93.00
	10°	499	99.80	676	96.57	890	89.00
	28°	484	96.80	656	93.71	863	86.30
	55°	411	82.28	558	79.65	734	73.36

Remote Driver Selection

Brand	Manufacturer code	Type	Watt	IP Rate	Number of fixtures
ALVIT Italy	AL1435S-IP	constant current 350mA	14W	IP67	min 1 - max 2
ALVIT Italy	AL1450S-IP	constant current 500mA	14W	IP67	1
ALVIT Italy	AL1470S-IP	constant current 700mA	14W	IP67	1
TCl Italy	152014/350	constant current 350mA	17W	IP68	min 1 - max 3
TCl Italy	152014/500	constant current 500mA	24W	IP68	min 1 - max 3
TCl Italy	152014/700	constant current 700mA	30W	IP68	min 1 - max 3



PRODUCT WEIGHT 0,30 kg

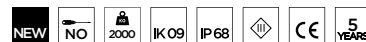

Code Example

201081 · .27 · .15 · GL · 0

Accessories p. 90

Hydrofloor Nano XXS All-Glass

Round ground-recessed luminaire for outdoor installation flush with the ground, hard anodized black aluminium body and cover/diffuser made entirely in tempered safety glass, moulded silicone gasket. Remote constant current 350 mA driver needed, with 1 CREE XP-G2 LED. IP68 rating.

201081

1W

CCT	Beam Angle	lm	lm/w	Finish	Dimming
.27 2700°K	.15 15°	71	71.00	.GL <input type="checkbox"/> Clear Glass	.0 ON/OFF
	.30 30°	62	62.00		
	.45 45°	57	57.00		
.30 3000°K	.15 15°	75	75.00		
	.30 30°	65	65.00		
	.45 45°	60	60.00		
.40 4000°K	.15 15°	80	80.00		
	.30 30°	70	70.00		
	.45 45°	65	65.00		

Remote Driver Selection

Brand	Manufacturer code	Type	Watt	IP Rate	Number of fixtures
ALVIT Italy	AL1435S-IP	constant current 350mA	14W	IP67	min 1 - max 8
Meanwell	LPC-20-350	constant current 350mA	16.8W	IP67	min 4 - max 12

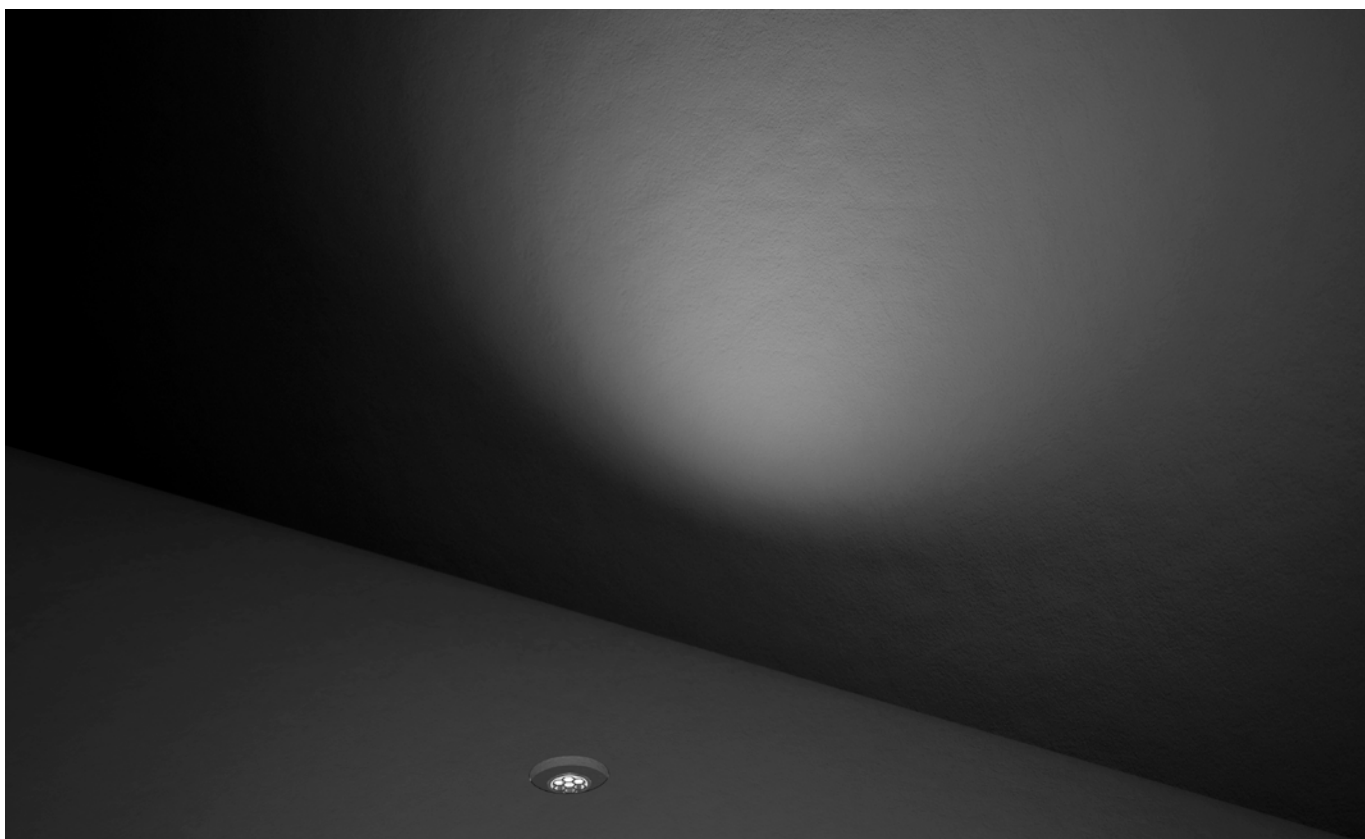

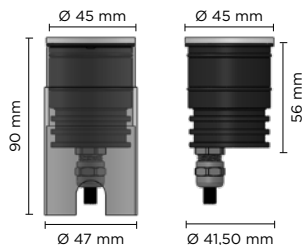

PRODUCT WEIGHT 0,90 kg

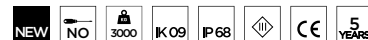

Hydrofloor Nano XS All-Glass

Round ground-recessed luminaire for outdoor installation flush with the ground, hard anodized black aluminium body and cover/diffuser made entirely in tempered safety glass, moulded silicone gasket. Remote constant current max 700 mA driver needed, with 1 CREE XP-L LED. IP68 rating.

Code Example

201082 .27 .10 .GL .0

Accessories p. 90

201082
Max 2,5W

CCT	Beam Angle	Finish	Dimming
.27 2700°K	.10 10°	.GL <input type="checkbox"/> Clear Glass	.0 ON/OFF
	.30 30°		
	.45 45°		
.30 3000°K	.10 10°		
	.30 30°		
	.45 45°		
.40 4000°K	.10 10°		
	.30 30°		
	.45 45°		

CCT	Beam Angle	350 mA LED POWER 1.2W		500 mA LED POWER 1.7W		700 mA LED POWER 2.5W	
		lm	lm/w	lm	lm/w	lm	lm/w
2700°K	10°	131	109.00	186	109.00	274	109.00
	30°	124	103.00	178	105.00	261	104.00
	45°	118	98.00	168	99.00	247	99.00
3000°K	10°	138	115.00	196	115.00	288	115.00
	30°	132	110.00	187	110.00	275	110.00
	45°	125	104.00	177	104.00	260	104.00
4000°K	10°	144	120.00	204	120.00	300	120.00
	30°	137	114.00	194	114.00	285	114.00
	45°	131	109.00	186	109.00	273	109.00

Remote Driver Selection

Brand	Manufacturer code	Type	Watt	IP Rate	Number of fixtures
ALVIT Italy	AL1435S-IP	constant current 350mA	14W	IP67	min 1 - max 8
ALVIT Italy	AL1450S-IP	constant current 500mA	14W	IP67	min 1 - max 6
ALVIT Italy	AL1470S-IP	constant current 700mA	14W	IP67	min 1 - max 4

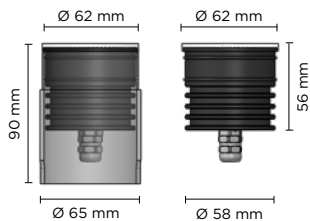

PRODUCT WEIGHT 1,10 kg



Hydrofloor Nano All-Glass

Code Example

201083.27.04.GL.0

Accessories p. 90

Round ground-recessed luminaire for outdoor installation flush with the ground, hard anodized black aluminium body and cover/diffuser made entirely in tempered safety glass, moulded silicone gasket. Remote constant current max 700 mA driver needed, with 1 CREE XHP35 HD LED. IP68 rating.

201083

Max 10W

CCT	Beam Angle	Finish	Dimming
.27 2700°K	.04 4°	.GL <input type="checkbox"/> Clear Glass	.0 ON/OFF
	.10 10°		
	.28 28°		
	.55 55°		
.30 3000°K	.04 4°	.GL <input type="checkbox"/> Clear Glass	.0 ON/OFF
	.10 10°		
	.28 28°		
	.55 55°		
.40 4000°K	.04 4°	.GL <input type="checkbox"/> Clear Glass	.0 ON/OFF
	.10 10°		
	.28 28°		
	.55 55°		

CCT	Beam Angle	350 mA LED POWER 5W		500 mA LED POWER 7W		700 mA LED POWER 10W	
		lm	lm/w	lm	lm/w	lm	lm/w
2700°K	4°	485	97.00	656	93.71	862	86.20
	10°	465	93.00	629	89.86	828	82.80
	28°	450	90.00	610	87.14	804	80.40
	55°	383	76.60	519	74.14	683	68.30
3000°K	4°	510	102.00	690	98.57	907	90.69
	10°	489	97.80	662	94.57	872	87.20
	28°	474	94.80	642	91.71	846	84.60
	55°	403	80.58	546	77.95	719	71.91
4000°K	4°	520	104.00	703	100.43	930	93.00
	10°	499	99.80	676	96.57	890	89.00
	28°	484	96.80	656	93.71	863	86.30
	55°	411	82.28	558	79.65	734	73.36

Remote Driver Selection

Brand	Manufacturer code	Type	Watt	IP Rate	Number of fixtures
ALVIT Italy	AL1435S-IP	constant current 350mA	14W	IP67	min 1 - max 2
ALVIT Italy	AL1450S-IP	constant current 500mA	14W	IP67	1
ALVIT Italy	AL1470S-IP	constant current 700mA	14W	IP67	1
TCI Italy	152014/350	constant current 350mA	17W	IP68	min 1 - max 3
TCI Italy	152014/500	constant current 500mA	24W	IP68	min 1 - max 3
TCI Italy	152014/700	constant current 700mA	30W	IP68	min 1 - max 3

INTEGRATED ACCESSORIES

201074 . 27 . 15 . SS . 0 . _ _ _

Built-in accessories to be requested when ordering
example 201074.27.15.SS.0.HC

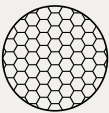

.HC

HONEYCOMB

A honeycomb structure designed to shield the light beam, reduce glare, and eliminate direct exposure to the light source.

Available for:

HYDROFLOOR **NANO XXS**
HYDROFLOOR **NANO XS**
HYDROFLOOR **NANO**
HYDROFLOOR **NANO XXS ALL GLASS**
HYDROFLOOR **NANO XS ALL GLASS**
HYDROFLOOR **NANO ALL GLASS**



.GS

STANDARD GLARE SHIELD

Glare shield accessory made in hard anodized black aluminum, providing good balance in between glare control and light output.

Available for:

HYDROFLOOR **NANO XS**
HYDROFLOOR **NANO**
HYDROFLOOR **NANO XS ALL GLASS**
HYDROFLOOR **NANO ALL GLASS**



.SC

SUPER COMFORT GLARE SHIELD

Glare shield accessory made in hard anodized black aluminum, for applications requiring very reduced glaring; minimal light loss on the light surface but overall lumen output typically reduced by 50%.

Available for:

HYDROFLOOR **NANO XS**
HYDROFLOOR **NANO**
HYDROFLOOR **NANO XS ALL GLASS**
HYDROFLOOR **NANO ALL GLASS**

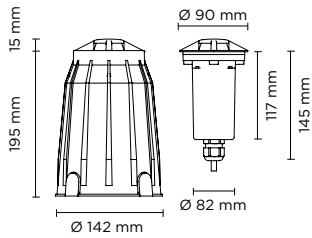

PRODUCT WEIGHT 1,00 kg



Code Example

201075 .27 .90 .01 .0

Accessories p. 100

Hydrofloor Micro 01

Round ground-recessed luminaire diam. 98 mm for outdoor installation, Phospho-chromatised and polyester powder coated die-cast copper-free aluminium body and top cover with one window (single light emission 1 x 90°), polycarbonate diffuser, moulded silicone gasket. Built-in LED driver 220-240V 50-60Hz, with 1 CREE XP-G2 LED. IP67 rating.

201075

3W

CCT	Beam Angle	lm	lm/w	Finish	Dimming
.27 2700°K	.90 1x90°	52	17.33	.01 RAL 9006	.0 ON/OFF
.30 3000°K	.90 1x90°	55	18.33	.02 RAL 7016	
.40 4000°K	.90 1x90°	60	20.00	.03 RAL 9005	

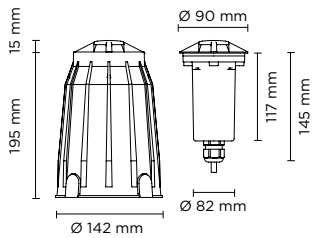

PRODUCT WEIGHT 1,00 kg

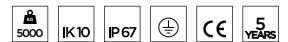

Code Example

201076 .27 .HB .01 .0

Accessories p. 100

Hydrofloor Micro 02

Round ground-recessed luminaire diam. 98 mm for outdoor installation, Phospho-chromatised and polyester powder coated die-cast copper-free aluminium body and top cover with two windows (double sides light emission 2 x 90°), polycarbonate diffuser, moulded silicone gasket. Built-in LED driver 220-240V 50-60Hz, with 1 CREE XP-G2 LED. IP67 rating.

201076

3W

CCT	Beam Angle	lm	lm/w	Finish	Dimming
.27 2700°K	.HB 2x90°	95	31.66	.01 RAL 9006	.0 ON/OFF
.30 3000°K	.HB 2x90°	100	33.33	.02 RAL 7016	
.40 4000°K	.HB 2x90°	105	35.00	.03 RAL 9005	

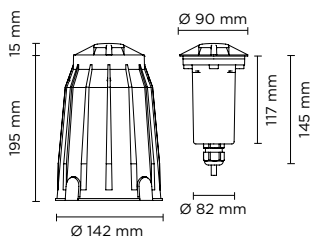

PRODUCT WEIGHT 1,00 kg



Code Example

201077 .27 .AL .01 .0

Accessories p. 100

Hydrofloor Micro 04

Round ground-recessed luminaire diam. 98 mm for outdoor installation, Phospho-chromatised and polyester powder coated die-cast copper-free aluminium body and top cover with four windows (four sides light emission 4 x 90°), polycarbonate diffuser, moulded silicone gasket. Built-in LED driver 220-240V 50-60Hz, with 1 CREE XP-G2 LED. IP67 rating.

201077

3W

CCT	Beam Angle	lm	lm/w	Finish	Dimming
.27 2700°K	.AL 4x90°	152	50.66	.01 RAL 9006	.0 ON/OFF
.30 3000°K	.AL 4x90°	160	53.33	.02 RAL 7016	
.40 4000°K	.AL 4x90°	170	56.67	.03 RAL 9005	

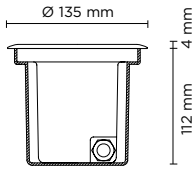

HOLE FOR RECESSING Ø 121 mm



PRODUCT WEIGHT 1,25 kg



Code Example

201012 · .27 · .10 · SS · 0

Accessories p. 100

Hydrofloor Mini

Round ground-recessed luminaire for outdoor installation, Phospho-chromatised and polyester powder coated die-cast copper-free aluminium body and stainless steel AISI 304 frame, tempered safety glass, moulded silicone gasket. Built-in LED driver 220-240V 50-60Hz, with 3 CREE XP-G3 LED. IP67 rating.

201012

3W

CCT	Beam Angle	Im	lm/w	Finish	Dimming
.27 2700°K	.10 10°	329	106.33	.SS Stainless Steel	.0 ON/OFF
	.30 30°	313	104.33		
	.45 45°	296	98.66		
.30 3000°K	.10 10°	346	115.33	.SS Stainless Steel	.0 ON/OFF
	.30 30°	329	109.66		
	.45 45°	312	104.00		
.40 4000°K	.10 10°	360	120.00	.SS Stainless Steel	.0 ON/OFF
	.30 30°	342	114.00		
	.45 45°	325	108.33		

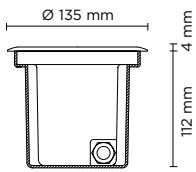

HOLE FOR RECESSING Ø 121 mm



PRODUCT WEIGHT 1,20 kg

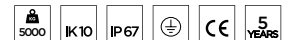

Code Example

201017 · .00 · .00 · SS · 0

Accessories p. 100

Hydrofloor Mini Roud GU10

Round ground-recessed luminaire for outdoor installation, Phospho-chromatised and polyester powder coated die-cast copper-free aluminium body and stainless steel AISI 304 frame, tempered safety glass, moulded silicone gasket. GU10 LED / halogen. IP67 rating.

201017

Max 35W

Light Source	Light Color	Light Beam Option	Finish	Dimming
GU10 LED / HALOGEN	SEE BULB FEATURES	SEE BULB FEATURES	.SS Stainless Steel	.0 ON/OFF

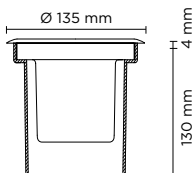

HOLE FOR RECESSING Ø 121 mm



PRODUCT WEIGHT 1,20 kg



Code Example

201019 · .00 · .00 · SS · 0

Accessories p. 100

Hydrofloor Mini Steel AISI 316 Round GU10

Round ground-recessed luminaire for outdoor installation, Stainless steel AISI 316 body and frame, tempered safety glass, moulded silicone gasket. GU10 LED / halogen. IP67 rating.

201019

35W

Light Source	Light Color	Light Beam Option	Finish	Dimming
GU10 LED / HALOGEN	SEE BULB FEATURES	SEE BULB FEATURES	.SS Stainless Steel	.0 ON/OFF

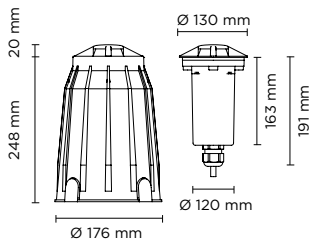

PRODUCT WEIGHT 2,00 kg



Hydrofloor Mini 01

Code Example

201078 .27 .90 .01 .0

Accessories p. 100

Round ground-recessed luminaire diam. 138 mm for outdoor installation, Phospho-chromatised and polyester powder coated die-cast copper-free aluminium body and top cover with one window (single light emission 1 x 90°), polycarbonate diffuser, moulded silicone gasket. Built-in LED driver 220-240V 50-60Hz, with 1 CREE XHP-35 LED. IP67 rating.

201078

9W

CCT	Beam Angle	lm	lm/w	Finish	Dimming
.27 2700°K	.90 1x90°	209	23.22	.01 RAL 9006	.0 ON/OFF
.30 3000°K	.90 1x90°	220	24.45	.02 RAL 7016	.D DALI
.40 4000°K	.90 1x90°	240	26.67	.03 RAL 9005	

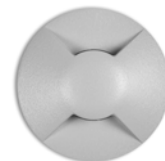
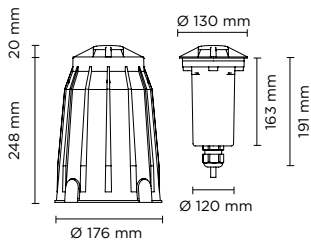

PRODUCT WEIGHT 2,00 kg



Hydrofloor Mini 02

Code Example

201079 .27 .HB .01 .0

Accessories p. 100

Round ground-recessed luminaire diam. 138 mm for outdoor installation, Phospho-chromatised and polyester powder coated die-cast copper-free aluminium body and top cover with two windows (double sides light emission 2 x 90°), polycarbonate diffuser, moulded silicone gasket. Built-in LED driver 220-240V 50-60Hz, with 1 CREE XHP-35 LED. IP67 rating.

201079

9W

CCT	Beam Angle	lm	lm/w	Finish	Dimming
.27 2700°K	.HB 2x90°	314	34.88	.01 RAL 9006	.0 ON/OFF
.30 3000°K	.HB 2x90°	330	36.67	.02 RAL 7016	.D DALI
.40 4000°K	.HB 2x90°	340	37.78	.03 RAL 9005	

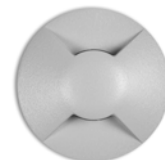
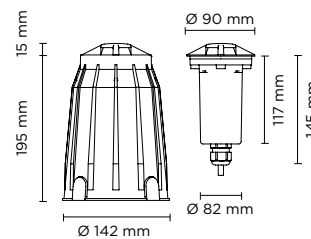

PRODUCT WEIGHT 2,00 kg



Hydrofloor Mini 04

Code Example

201080 .27 .AL .01 .0

Accessories p. 100

Round ground-recessed luminaire diam. 138 mm for outdoor installation, Phospho-chromatised and polyester powder coated die-cast copper-free aluminium body and top cover with four windows (four sides light emission 4 x 90°), polycarbonate diffuser, moulded silicone gasket. Built-in LED driver 220-240V 50-60Hz, with 1CREE XHP-35 LED. IP67 rating.

201080

9W

CCT	Beam Angle	lm	lm/w	Finish	Dimming
.27 2700°K	.AL 4x90°	399	44.33	.01 RAL 9006	.0 ON/OFF
.30 3000°K	.AL 4x90°	420	46.67	.02 RAL 7016	.D DALI
.40 4000°K	.AL 4x90°	430	47.78	.03 RAL 9005	

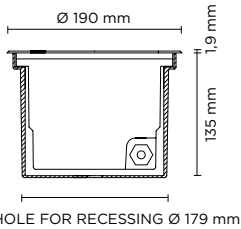

PRODUCT WEIGHT 2,20 kg



Code Example

201024 .27 .10 .SS .0

Accessories p. 100

Hydrofloor Medium

Round ground-recessed luminaire for outdoor installation, Phospho-chromatised and polyester powder coated die-cast copper-free aluminium body and stainless steel AISI 304 frame, tempered safety glass, moulded silicone gasket.

Built-in LED driver 220-240V 50-60Hz, with 5 CREE XP-G3 LED. IP67 rating.

201024

8W

CCT	Beam Angle	lm	lm/w	Finish	Dimming
.27 2700°K	.10 10°	684	85.5	.SS Stainless Steel	.0 ON/OFF
	.30 30°	650	81.25		.1 1-10 V
	.45 45°	618	77.25		.D DALI
.30 3000°K	.10 10°	720	90.00		
	.30 30°	684	85.50		
	.45 45°	650	81.25		
.40 4000°K	.10 10°	750	93.75		
	.30 30°	713	89.13		
	.45 45°	677	84.63		

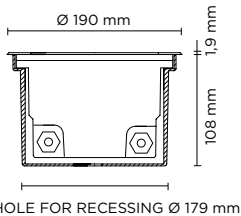

PRODUCT WEIGHT 2,20 kg



Code Example

201058 .27 .10 .SS .0

Accessories p. 100

Hydrofloor Medium Compact

Round compact ground-recessed luminaire for outdoor installation, Phospho-chromatised and polyester powder coated die-cast copper-free aluminium body and stainless steel AISI 304 frame, tempered safety glass, moulded silicone gasket. Built-in LED driver 220-240V 50-60Hz, with 5 CREE XP-G3 LED. IP67 rating.

201058

8W

CCT	Beam Angle	lm	lm/w	Finish	Dimming
.27 2700°K	.10 10°	685	85.62	.SS Stainless Steel	.0 ON/OFF
	.30 30°	650	81.25		
	.45 45°	618	77.25		
.30 3000°K	.10 10°	720	90.00		
	.30 30°	684	85.50		
	.45 45°	650	81.25		
.40 4000°K	.10 10°	750	93.75		
	.30 30°	713	89.13		
	.45 45°	677	84.63		

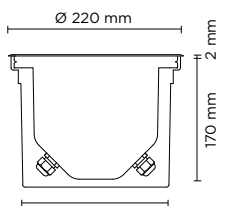

HOLE FOR RECESSING Ø 210 mm



PRODUCT WEIGHT 2,50 kg



Code Example

201064.27.10.SS.0

Accessories p. 100

Hydrofloor Medium Steel AISI 316

Round ground-recessed luminaire for outdoor installation, stainless steel AISI 316 body and frame, tempered safety glass, moulded silicone gasket. Built-in LED driver 220-240V 50-60Hz, with 5 CREE XP-G3 LED. IP67 rating.

201064

8W

CCT	Beam Angle	lm	lm/w
.27 2700°K	.10 10°	686	85.75
	.30 30°	650	81.25
	.45 45°	618	77.25
.30 3000°K	.10 10°	720	90.00
	.30 30°	684	85.50
	.45 45°	650	81.25
.40 4000°K	.10 10°	750	93.75
	.30 30°	713	89.13
	.45 45°	677	84.63

Finish

.SS Stainless Steel

Dimming

.0 ON/OFF

.1 1-10 V

.D DALI

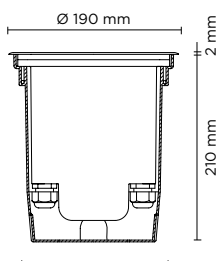

HOLE FOR RECESSING Ø 179 mm



PRODUCT WEIGHT 4,00 kg



Code Example

201068.27.20.SS.0

Accessories p. 100

Hydrofloor Medium COB

Ground-recessed luminaire in round shape for outdoor installation, phospho-chromatised and polyester powder coated die-cast copper-free aluminium body and stainless steel AISI 304 frame, tempered safety glass, moulded silicone gasket. Symmetrical light distribution with adjustable optics. Built-in LED driver 220-240V 50-60Hz, with 1 CREE CXB 2530 COB LED. IP67 rating.

201068

19W

CCT	Beam Angle	lm	lm/w
.27 2700°K	.20 20°	1.762	195.78
	.40 40°	1.712	190.22
.30 3000°K	.20 20°	1.855	97.63
	.40 40°	1.802	94.84
.40 4000°K	.20 20°	1.999	105.21
	.40 40°	1.923	101.21

Finish

.SS Stainless Steel

Dimming

.0 ON/OFF

.1 1-10 V

.D DALI

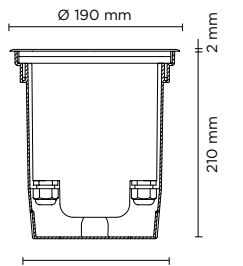

HOLE FOR RECESSING Ø 179 mm

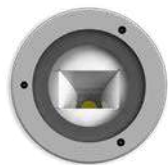

PRODUCT WEIGHT 4,00 kg

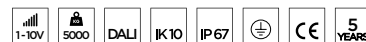

Code Example

201070.**.27**.**WW**.**SS**.**.0**

Accessories p. 100

Hydrofloor Medium COB Asymmetric

Ground-recessed luminaire in round shape for outdoor installation, phospho-chromatised and polyester powder coated die-cast copper-free aluminium body and stainless steel AISI 304 frame, tempered safety glass, moulded silicone gasket. Asymmetrical “wall-washer” light distribution. Built-in LED driver 220-240V 50-60Hz, with 1 CREE CXB 2530 COB LED. IP67 rating.

201070

19W

CCT	Beam Angle	Im	Im/w	Finish	Dimming
.27 2700°K	.WW Asym. Wall Washer	1.410	74.21	.SS Stainless Steel	.0 ON/OFF
.30 3000°K	.WW Asym. Wall Washer	1.484	78.10		.1 1-10 V
.40 4000°K	.WW Asym. Wall Washer	1.599	84.16		.D DALI

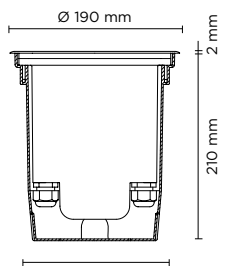

HOLE FOR RECESSING Ø 179 mm



PRODUCT WEIGHT 2,40 kg



Code Example

201068.**.RW**.**.12**.**SS**.**.D**

Accessories p. 100

Hydrofloor Medium DMX RGBW

Ground-recessed luminaire in round shape for outdoor installation, phospho-chromatised and polyester powder coated die-cast copper-free aluminium body and stainless steel AISI 304 frame, tempered safety glass, moulded silicone gasket. Built-in LED driver, DMX driver integrated; with 3 x CREE “XML” RGBW LED. IP67 rating.

201068

14W

CCT	Beam Angle	Im	Im/w	Finish	Dimming
.RW RGBW	.12 12°	480	34.28	.SS Stainless Steel	.D DALI
	.25 25°	468	33.43		.X DMX
	.35 35°	457	32.65		

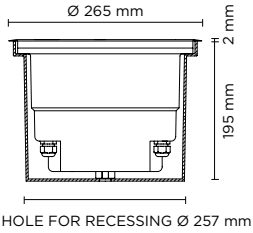

PRODUCT WEIGHT 5,00 kg



Code Example

201034.**.30**.**.10**.**.SS**.**.0**

Accessories p. 100

Hydrofloor Maxi

Round ground-recessed luminaire for outdoor installation, Phospho-chromatised and polyester powder coated die-cast copper-free aluminium body and stainless steel AISI 304 frame, tempered safety glass, moulded silicone gasket. Built-in LED driver 220-240V 50-60Hz, with 8 CREE XP-G3 LED. IP67 rating.

201034

12W

CCT	Beam Angle	lm	lm/w	Finish	Dimming
.30 3000°K	.10 10°	1.152	96.00	.SS Stainless Steel	.0 ON/OFF
	.30 30°	1.095	91.25		.1 1-10 V
	.45 45°	1.040	86.67		.D DALI
.40 4000°K	.10 10°	1.200	100.00	.SS Stainless Steel	.0 ON/OFF
	.30 30°	1.140	95.00		.1 1-10 V
	.45 45°	1.083	90.25		.D DALI

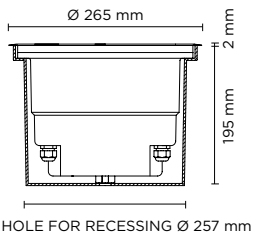

PRODUCT WEIGHT 5,10 kg



Code Example

201034.**.RW**.**.12**.**.SS**.**.D**

Accessories p. 100

Hydrofloor Maxi DMX RGBW

Ground-recessed luminaire in round shape for outdoor installation, phospho-chromatised and polyester powder coated die-cast copper-free aluminium body and stainless steel AISI 304 frame, tempered safety glass, moulded silicone gasket. Built-in LED driver, DMX driver integrated; with 6 x CREE "XML" RGBW LED. IP67 rating.

201034

28W

CCT	Beam Angle	lm	lm/w	Finish	Dimming
.RW RGBW	.12 12°	1.000	35.71	.SS Stainless Steel	.D DALI
	.25 25°	992	35.43		.X DMX
	.35 35°	981	35.04		

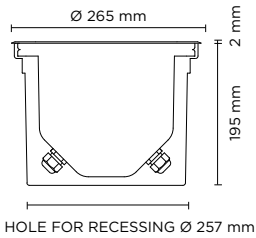

PRODUCT WEIGHT 5,50 kg



Code Example

201069 · .27 · .20 · .SS · .0

Accessories p. 100

Hydrofloor Maxi COB

Ground-recessed luminaire in round shape for outdoor installation, phospho-chromatised and polyester powder coated die-cast copper-free aluminium body and stainless steel AISI 304 frame, tempered safety glass, moulded silicone gasket. Symmetrical light distribution with adjustable optics. Built-in LED driver 220-240V 50-60Hz, with 1 CREE CXB 3050 COB LED. IP67 rating.

201069

32W

CCT	Beam Angle	lm	lm/w	Finish	Dimming
.27 2700°K	.20 20°	3.779	118.09	.SS Stainless Steel	.0 ON/OFF
	.40 40°	3.716	116.25		.1 1-10 V
.30 3000°K	.20 20°	3.978	124.31		.D DALI
	.40 40°	3.912	122.25		
.40 4000°K	.20 20°	4.050	126.56		
	.40 40°	4.001	125.03		

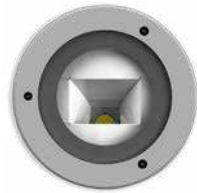
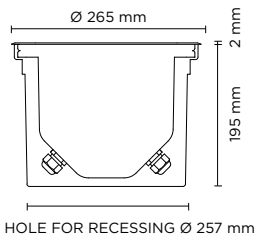

PRODUCT WEIGHT 5,50 kg



Code Example

201071 · .27 · .WW · .SS · .0

Accessories p. 100

Hydrofloor Maxi COB Asymmetric

Ground-recessed luminaire in round shape for outdoor installation, phospho-chromatised and polyester powder coated die-cast copper-free aluminium body and stainless steel AISI 304 frame, tempered safety glass, moulded silicone gasket. Asymmetrical "wall-washer" light distribution. Built-in LED driver 220-240V 50-60Hz, with 1 CREE CXB 3050 COB LED. IP67 rating.

201071

32W

CCT	Beam Angle	lm	lm/w	Finish	Dimming
.27 2700°K	.WW Asym. Wall Washer	3.023	94.46	.SS Stainless Steel	.0 ON/OFF
	.30 3000°K	.WW Asym. Wall Washer	3.182		99.43
.40 4000°K	.WW Asym. Wall Washer	3.240	101.25		.D DALI

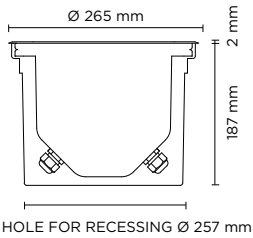

PRODUCT WEIGHT 5,50 kg



Code Example

201059.**27**.**10**.**SS**.**0**

Accessories p. 100

201059

12W

Hydrofloor Maxi Steel AISI 316

Round compact ground-recessed luminaire for outdoor installation, stainless steel AISI 316 body and frame, tempered safety glass, moulded silicone gasket. Built-in LED driver 220-240V 50-60Hz, with 8 CREE XP-G3 LED. IP67 rating.

CCT	Beam Angle	lm	lm/w
.27 2700°K	.10 10°	1094	91.17
	.30 30°	1040	86.67
	.45 45°	988	82.33
.30 3000°K	.10 10°	1.152	96.00
	.30 30°	1.095	91.25
	.45 45°	1.040	86.67
.40 4000°K	.10 10°	1.200	100.00
	.30 30°	1.140	95.00
	.45 45°	1.083	90.25

Finish

.SS Stainless Steel

Dimming

.0 ON/OFF

.1 1-10 V

.D DALI

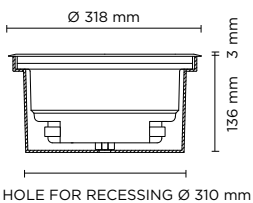

PRODUCT WEIGHT 5,00 kg



Code Example

201048.**27**.**10**.**SS**.**0**

Accessories p. 100

201048

22W

Hydrofloor Maxi Compact

Round compact ground-recessed luminaire for outdoor installation, Phospho-chromatised and polyester powder coated die-cast copper-free aluminium body and stainless steel AISI 304 frame, tempered safety glass, moulded silicone gasket. Built-in LED driver 220-240V 50-60Hz, with 15 CREE XP-G3 LED. IP67 rating.

CCT	Beam Angle	lm	lm/w
.27 2700°K	.10 10°	2052	93.27
	.30 30°	1949	88.59
	.45 45°	1852	84.18
.30 3000°K	.10 10°	2.160	98.18
	.30 30°	2.052	93.27
	.45 45°	1.949	88.60
.40 4000°K	.10 10°	2.250	102.28
	.30 30°	2.137	97.14
	.45 45°	2.030	92.27

Finish

.SS Stainless Steel

Dimming

.0 ON/OFF

.1 1-10 V

.D DALI

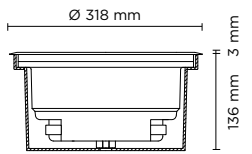

HOLE FOR RECESSING Ø 310 mm



PRODUCT WEIGHT 5,00 kg



Code Example

201062 .30 .10 SS .0

Accessories p. 100

Hydrofloor Maxi Compact Pro

Round compact ground-recessed luminaire for outdoor installation, Phospho-chromatised and polyester powder coated die-cast copper-free aluminium body and stainless steel AISI 304 frame, tempered safety glass, moulded silicone gasket. Built-in LED driver 220-240V 50-60Hz, with 15 CREE XP-L LED. IP67 rating.

201062

40W

CCT	Beam Angle	lm	lm/w	Finish	Dimming
.30 3000°K	.10 10°	3.680	92.00	.SS Stainless Steel	.0 ON/OFF
	.30 30°	3.500	87.50		.1 1-10 V
	.45 45°	3.320	83.00		.D DALI

ACCESSORIES NOT INCLUDED

Accessories to be ordered separately.

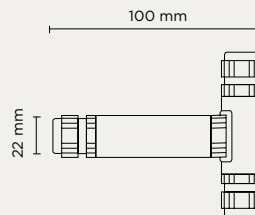
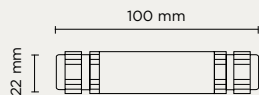

AC005

CONNECTOR 02-2 WAYS

High-performance in-line and branch electrical connection joints, designed to ensure maximum protection against water and dust and long-term reliability. Their construction allows easy maintenance operations without compromising the integrity and safety of the connection. Compatible for all products of the series.

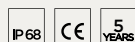

AC006

CONNECTOR 03-3 WAYS

3-pole straight connector designed for direct inline connections in outdoor lighting systems. Its robust and fully waterproof construction ensures high reliability in harsh environmental conditions, making it ideal for permanent outdoor installations. Compatible for all products of the series.



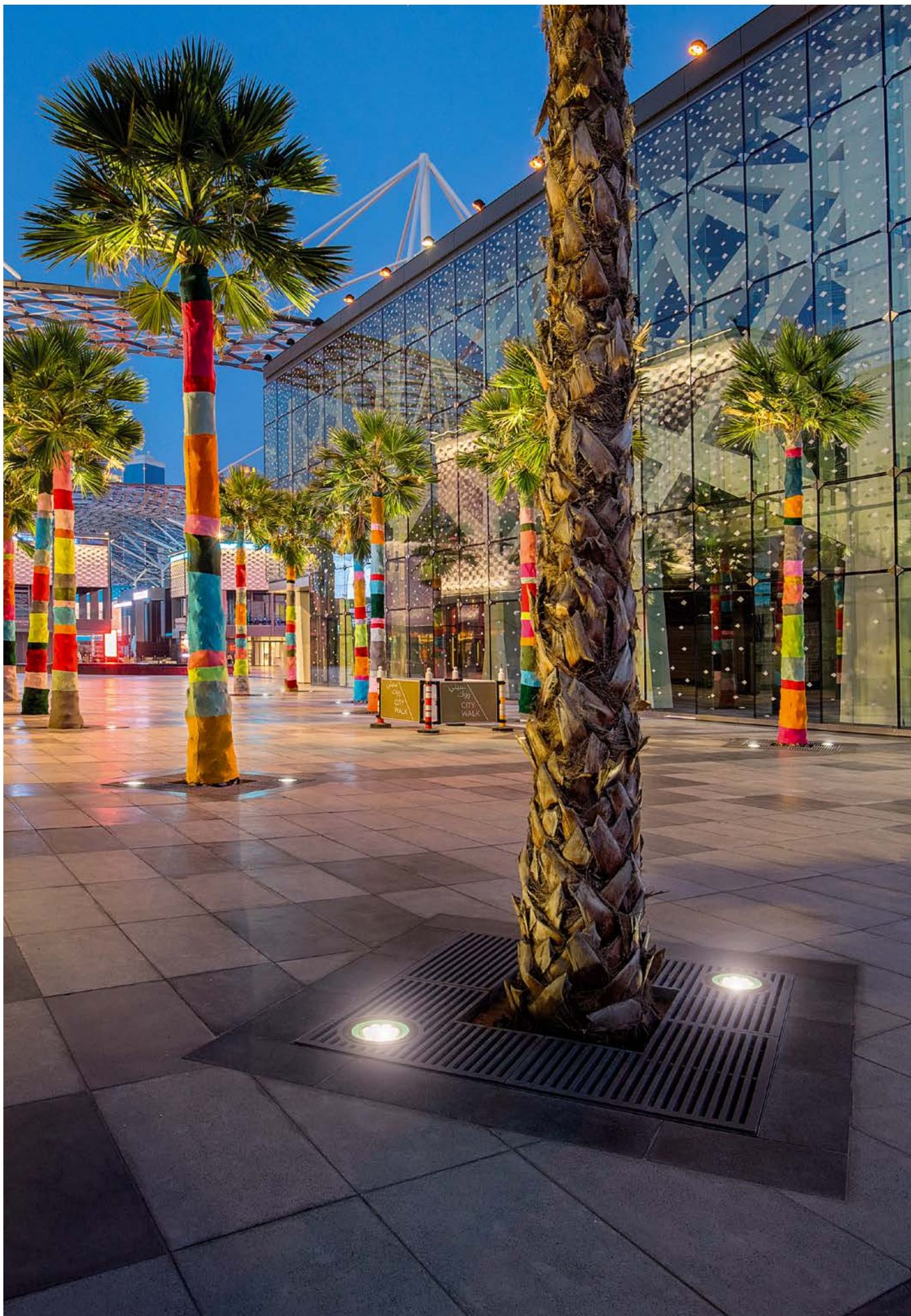



Hydrofloor Invisa

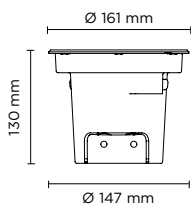

PRODUCT WEIGHT 2,00 kg



Code Example

206001.30.15.03.0

Accessories p. 13

Hydrofloor Mini Invisa

ALL BLACK APPEARANCE.

Round compact ground-recessed luminaire for outdoor installation, Phospho-chromatised and polyester powder coated die-cast copper-free aluminium body and stainless steel AISI 304 frame, tempered safety glass, moulded silicone gasket, non-visible stainless steel screws. Built-in LED driver 220-240V 50-60Hz, with 4 CREE XP-G2 LED + special optics with "invisa-light" technology. IP67 rating.

206001

7W

CCT	Beam Angle	lm	lm/w	Finish	Dimming
.30 3000°K	.15 15°	595	85.00	.03 RAL 9005	.0 ON/OFF
	.35 35°	565	80.71	.SS Stainless Steel	.D DALI
	.55 55°	536	76.57		
.40 4000°K	.15 15°	630	90.00	.SS Stainless Steel	.D DALI
	.35 35°	598	85.43		
	.55 55°	568	81.14		

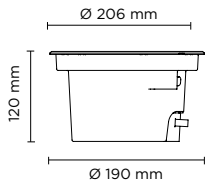

PRODUCT WEIGHT 3,00 kg



Code Example

206002·30·15·03·0

Accessories p. 13

Hydrofloor Medium Invisa

ALL BLACK APPEARANCE.

Round compact ground-recessed luminaire for outdoor installation, Phospho-chromatised and polyester powder coated die-cast copper-free aluminium body and stainless steel AISI 304 frame, tempered safety glass, moulded silicone gasket, non-visible stainless steel screws. Built-in LED driver 220-240V 50-60Hz, with 9 CREE XP-G2 LED + special optics with “invisa-light” technology. IP67 rating.

206002

15W

CCT	Beam Angle	lm	lm/w	Finish	Dimming
.30 3000°K	.15 15°	1.296	86.40	.03 RAL 9005	.0 ON/OFF
	.35 35°	1.231	82.07	.SS Stainless Steel	.1 1-10 V
	.55 55°	1.170	78.00		
.40 4000°K	.15 15°	1.350	90.00	.SS Stainless Steel	.D DALI
	.35 35°	1.282	85.47		
	.55 55°	1.218	81.20		

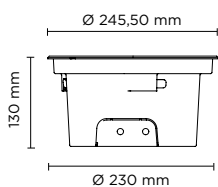

PRODUCT WEIGHT 4,50 kg



Code Example

206003·30·15·03·0

Accessories p. 13

Hydrofloor Maxi Invisa

ALL BLACK APPEARANCE.

Round compact ground-recessed luminaire for outdoor installation, Phospho-chromatised and polyester powder coated die-cast copper-free aluminium body and stainless steel AISI 304 frame, tempered safety glass, moulded silicone gasket, non-visible stainless steel screws. Built-in LED driver 220-240V 50-60Hz, with 16 CREE XP-G2 LED + special optics with “invisa-light” technology. IP67 rating.

206003

27W

CCT	Beam Angle	lm	lm/w	Finish	Dimming
.30 3000°K	.15 15°	2.232	82.67	.03 RAL 9005	.0 ON/OFF
	.35 35°	2.120	78.52	.SS Stainless Steel	.1 1-10 V
	.55 55°	2.014	74.59		
.40 4000°K	.15 15°	2.325	86.11	.SS Stainless Steel	.D DALI
	.35 35°	2.208	81.78		
	.55 55°	2.098	77.69		

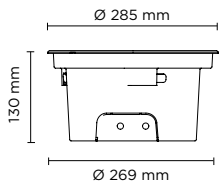

PRODUCT WEIGHT 6,00 kg



Code Example

206004.30.15.03.0

Accessories p. 13

Hydrofloor Mega Invisa

ALL BLACK APPEARANCE.

Round compact ground-recessed luminaire for outdoor installation, Phospho-chromatised and polyester powder coated die-cast copper-free aluminium body and stainless steel AISI 304 frame, tempered safety glass, moulded silicone gasket, non-visible stainless steel screws. Built-in LED driver 220-240V 50-60Hz, with 25 CREE XP-G2 LED + special optics with "invisa-light" technology. IP67 rating.

CCT	Beam Angle		lm	lm/w	Finish	Dimming				
206004 41W	.30	3000°K	.15	15°	3.720	90.73	.03 RAL 9005	.0	ON/OFF	
			.35	35°	3.534	86.19		.SS Stainless Steel	.1	1-10 V
			.55	55°	3.357	81.88			.D	DALI
	.40	4000°K	.15	15°	3.875	94.51				
			.35	35°	3.681	89.78				
			.55	55°	3.497	85.29				

Stainless steel finish trim available on request



Sliding hooking system for recessing box

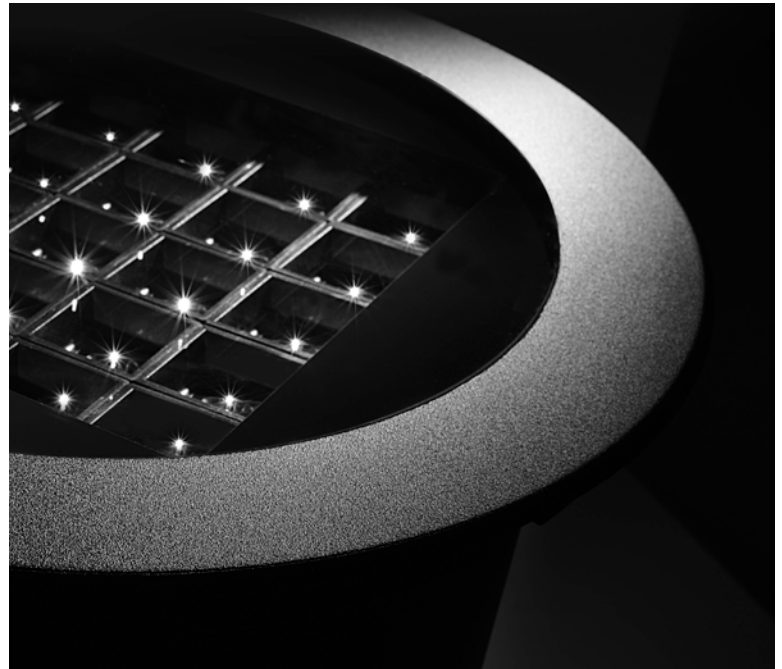

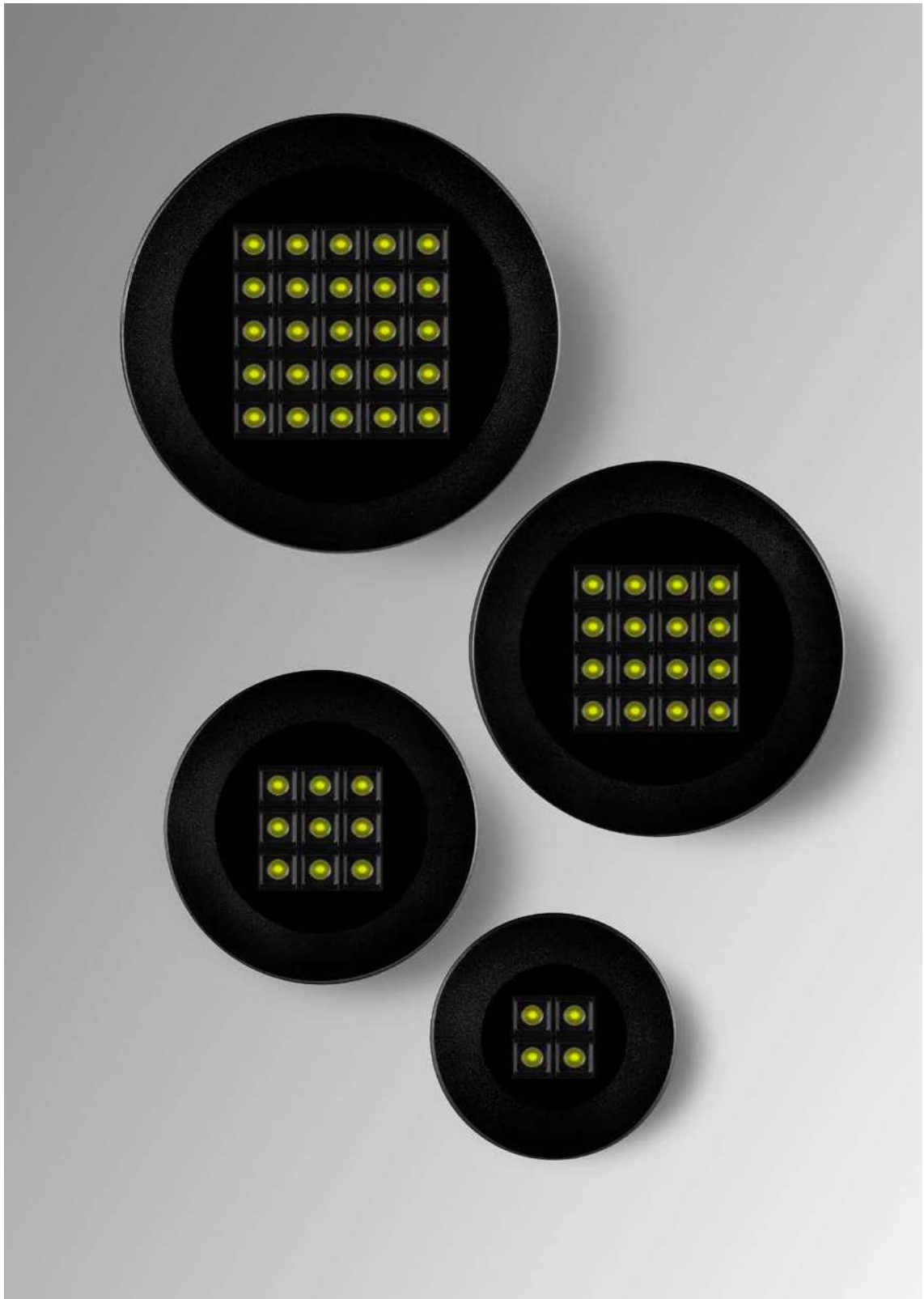



Hydrofloor Vetro

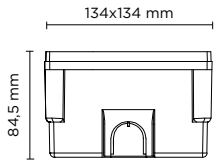

PRODUCT WEIGHT 1,40 kg



Hydrofloor Vetro Medium Square

Code Example

205001.27.10.GL.0

Square ground-recessed trimless uplight for outdoor installation, phospho-chromatised and polyester powder coated die-cast copper-free aluminium body, tempered safety glass, moulded silicone gasket. Built-in LED driver 220-240V 50-60Hz, with 5 CREE XP-G3 LED. IP67 rating.

205001

8W

CCT	Beam Angle	lm	lm/w
.27 2700°K	.10 10°	684	85.5
	.30 30°	650	81.25
	.45 45°	618	77,25
.30 3000°K	.10 10°	720	90.00
	.30 30°	684	85.50
	.45 45°	650	81.25
.40 4000°K	.10 10°	750	93.75
	.30 30°	713	89.13
	.45 45°	677	84.63

Finish

.GL Glass

Dimming

.0 ON/OFF

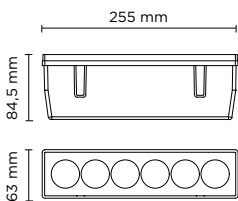

PRODUCT WEIGHT 1,40 kg



Hydrofloor Vetro Linear

Code Example

205002.27.10.GL.0

Linear ground-recessed trimless uplight for outdoor installation, phospho-chromatised and polyester powder coated die-cast copper-free aluminium body, tempered safety glass, moulded silicone gasket. Built-in LED driver 220-240V 50-60Hz, with 6 CREE XP-G3 LED. IP67 rating.

205002

10W

CCT	Beam Angle	lm	lm/w
.27 2700°K	.10 10°	855	57.00
	.30 30°	812	54.13
	.45 45°	771	51.40
.30 3000°K	.10 10°	900	90.00
	.30 30°	855	85.50
	.45 45°	812	81.20
.40 4000°K	.10 10°	940	94.00
	.30 30°	893	89.30
	.45 45°	848	84.80

Finish

.GL Glass

Dimming

.0 ON/OFF

.D DALI



Face-Up

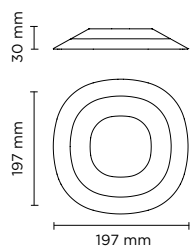

PRODUCT WEIGHT 1.20 kg



Face-Up Mini COB

Code Example

208001 · .27 · .18 · .01 · 0

Accessories p. 111

Uplight for outdoor installation on a ground/floor surface. Phospho-chromatised and polyester powder coated die-cast copper-free aluminium, tempered safety glass and stainless steel screws. With 1 direct 220-240V LUMENS "EDC 38C" COB LED. IP67 rating.

CCT	Beam Angle	lm	lm/w	Finish	Dimming
208001 8W	.27 2700°K	.18 18°	380 47.50	.01 RAL 9006	.0 ON/OFF
		.36 36°	371 46.38	.02 RAL 7016	
		.60 60°	356 44.50	.03 RAL 9005	
.30 3000°K	.18 18°	400 50.00			
	.36 36°	390 48.75			
	.60 60°	375 46.88			
.40 4000°K	.18 18°	410 51.25			
	.36 36°	400 50.00			
	.60 60°	385 48.13			

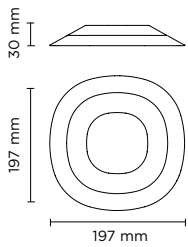

PRODUCT WEIGHT 1,20 kg



Face-Up Mini HP

Uplight for outdoor installation on a ground/floor surface. Phospho-chromatised and polyester powder coated die-cast copper-free aluminium, tempered safety glass and stainless steel screws. Remote constant current max 700mA needed, with 3 CREE XP-G3 LED. IP67 rating.

Code Example

208002, .27, .08, .01, .0

Accessories p. 111

208002

Max 6W

CCT	Beam Angle	Finish	Dimming
.27 2700°K	.08 8°	.01 RAL 9006	.0 ON/OFF
	.20 20°	.02 RAL 7016	
	.40 40°	.03 RAL 9005	
.30 3000°K	.08 8°		
	.20 20°		
	.40 40°		
.40 4000°K	.08 8°		
	.20 20°		
	.40 40°		

CCT	Beam Angle	350 mA LED POWER 3W		500 mA LED POWER 4.5W		700 mA LED POWER 6W	
		lm	lm/w	lm	lm/w	lm	lm/w
2700°K	8°	300	100.00	378	83.75	538	89.70
	20°	287	95.80	360	80.25	512	85.33
	40°	278	92.80	350	77.75	501	83.60
3000°K	8°	306	102.00	387	86.25	546	90.69
	20°	293	97.80	373	82.75	522	87.20
	40°	284	94.80	360	80.25	507	84.60
4000°K	8°	312	104.00	396	87.88	558	93.00
	20°	300	99.80	380	84.50	534	89.00
	40°	290	96.80	369	82.00	518	86.30

Remote Driver Selection

Brand	Manufacturer code	Type	Watt	IP Rate	Number of fixtures
ALVIT Italy	AL1435S-IP	constant current 350mA	14W	IP67	min 1 - max 4
ALVIT Italy	AL1450S-IP	constant current 500mA	14W	IP67	min 1 - max 3
ALVIT Italy	AL1470S-IP	constant current 700mA	14W	IP67	min 1 - max 2
TCI Italy	152014/350	constant current 350mA	17W	IP68	min 1 - max 5
TCI Italy	152014/500	constant current 500mA	24W	IP68	min 1 - max 5
TCI Italy	152014/700	constant current 700mA	30W	IP68	min 1 - max 4

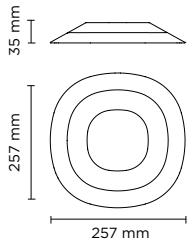

PRODUCT WEIGHT 2,00 kg



Code Example

208003·.27·.18·.01·.0

Accessories p. 111

Face-Up Medium COB

Uplight for outdoor installation on a ground/floor surface. Phospho-chromatised and polyester powder coated die-cast copper-free aluminium, tempered safety glass and stainless steel screws. With 1 direct 220-240V LUMENS "EDC 47C" COB LED. IP67 rating.

208003

15W

CCT	Beam Angle	lm	lm/w	Finish	Dimming
.27 2700°K	.18 18°	950	63.33	.01 RAL 9006	.0 ON/OFF
	.36 36°	931	62.06	.02 RAL 7016	
	.60 60°	912	60.80	.03 RAL 9005	
.30 3000°K	.18 18°	1.000	66.67		
	.36 36°	980	66.34		
	.60 60°	960	64.00		
.40 4000°K	.18 18°	1.050	70.00		
	.36 36°	1.030	68.67		
	.60 60°	1.000	66.67		

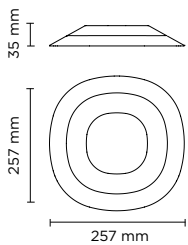

PRODUCT WEIGHT 2,00 kg



Code Example

208004·.27·.08·.01·.0

Accessories p. 111

Face-Up Medium HP

Uplight for outdoor installation on a ground/floor surface. Phospho-chromatised and polyester powder coated die-cast copper-free aluminium, tempered safety glass and stainless steel screws. Remote constant current max 700mA needed, with 6 CREE XP-G3 LED. IP67 rating

208004

Max 12W

CCT	Beam Angle	Finish	Dimming
.27 2700°K	.08 8°	.01 RAL 9006	.0 ON/OFF
	.20 20°	.02 RAL 7016	
	.40 40°	.03 RAL 9005	
.30 3000°K	.08 8°		
	.20 20°		
	.40 40°		
.40 4000°K	.08 8°		
	.20 20°		
	.40 40°		

CCT	Beam Angle	350 mA LED POWER 6W		500 mA LED POWER 9W		700 mA LED POWER 12W	
		lm	lm/w	lm	lm/w	lm	lm/w
2700°K	8°	600	100.00	756	83.75	1.076	89.70
	20°	574	95.80	720	80.25	1.024	85.33
	40°	556	92.80	700	77.75	1.002	83.60
3000°K	8°	612	102.00	774	86.25	1.092	90.69
	20°	586	97.80	746	82.75	1.044	87.20
	40°	568	94.80	720	80.25	1.014	84.60
4000°K	8°	624	104.00	792	87.88	1.116	93.00
	20°	600	99.80	760	84.50	1.068	89.00
	40°	580	96.80	738	82.00	1.136	86.30

Remote Driver Selection

Brand	Manufacturer code	Type	Watt	IP Rate	Number of fixtures
ALVIT Italy	AL1435S-IP	constant current 350mA	14W	IP67	min 1 - max 2
ALVIT Italy	AL1450S-IP	constant current 500mA	14W	IP67	1
ALVIT Italy	AL1470S-IP	constant current 700mA	14W	IP67	1
TCI Italy	152014/350	constant current 350mA	17W	IP68	min 1 - max 2
TCI Italy	152014/500	constant current 500mA	24W	IP68	min 1 - max 2
TCI Italy	152014/700	constant current 700mA	30W	IP68	min 1 - max 2

INTEGRATED ACCESSORIES

208001.27.18.01.0. _ _

Built-in accessories to be requested when ordering
example 208001.27.18.01.0.HC

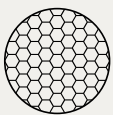

.HC

HONEYCOMB

A honeycomb structure designed to shield the light beam, reduce glare, and eliminate direct exposure to the light source.

ACCESSORIES NOT INCLUDED

Accessories to be ordered separately.



SPIKE

Ground-mounted installation accessory,
Available for:

AC122

FOR ALL FACE-UP MINI ITEMS

AC123

FOR ALL FACE-UP MEDIUM ITEMS



Hydrofloor Nano Linear

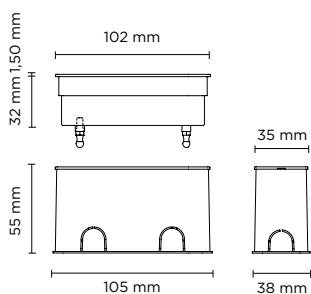

PRODUCT WEIGHT 0,50 kg



Code Example

209001.27.08.SS.0

Accessories p. 116

Hydrofloor Nano Linear HP

Linear shape ground-recessed luminaire for outdoor installation. Body in hard anodized aluminum with phospho-chromatised and polyester powder coating and frontal cover in stainless steel AISI 316L, tempered safety glass. Remote constant current max 700mA driver needed, with 3 CREE XP-G2 LED. IP68 rating.

209001

Max 6W

CCT	Beam Angle	Finish	Dimming
.27 2700°K	.08 8°	.SS Stainless Steel	.0 ON/OFF
	.32 32°		
	.45 45°		
.30 3000°K	.08 8°		
	.32 32°		
	.45 45°		
.40 4000°K	.08 8°		
	.32 32°		
	.45 45°		

CCT	Beam Angle	350 mA LED POWER 3W		500 mA LED POWER 4,5W		700 mA LED POWER 6W	
		lm	lm/w	lm	lm/w	lm	lm/w
2700°K	8°	300	100.00	378	83.75	538	89.70
	32°	287	95.80	360	80.25	512	85.33
	45°	278	92.80	350	77.75	501	83.60
3000°K	8°	306	102.00	387	86.25	546	90.69
	32°	293	97.80	373	82.75	522	87.20
	45°	284	94.80	360	80.25	507	84.60
4000°K	8°	312	104.00	396	87.88	558	93.00
	32°	300	99.80	380	84.50	534	89.00
	45°	290	96.80	369	82.00	518	86.30

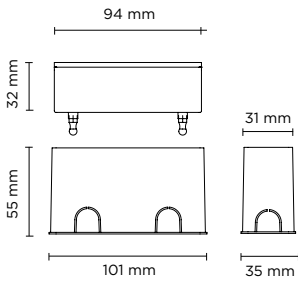

Code Example

209004.27.08.GL.0

Accessories p. 116

209004

Max 6W

Hydrofloor Nano Linear Trimless

Trimless version, all other details are same as model 209001

Finish

.GL Clear Glass

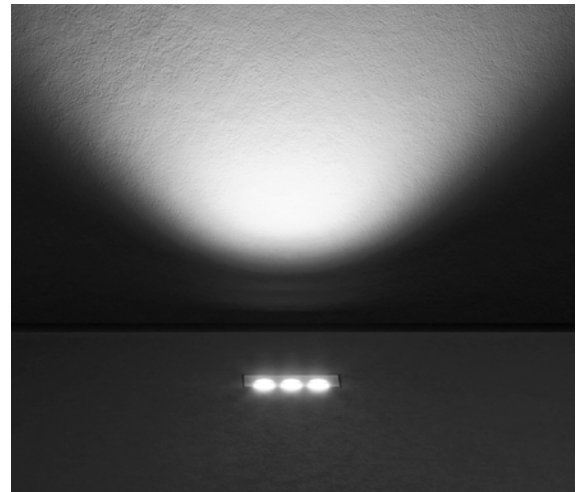

Remote Driver Selection

Brand	Manufacturer code	Type	Watt	IP Rate	Number of fixtures
ALVIT Italy	AL1435S-IP	constant current 350mA	14W	IP67	min 1 - max 4
ALVIT Italy	AL1450S-IP	constant current 500mA	14W	IP67	min 1 - max 3
ALVIT Italy	AL1470S-IP	constant current 700mA	14W	IP67	min 1 - max 2
TCI Italy	152014/350	constant current 350mA	17W	IP68	min 1 - max 5
TCI Italy	152014/500	constant current 500mA	24W	IP68	min 1 - max 5
TCI Italy	152014/700	constant current 700mA	30W	IP68	min 1 - max 4

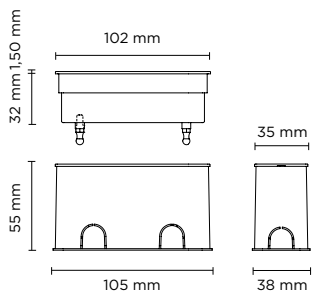

PRODUCT WEIGHT 0,50 kg



Code Example

209002, .27, .WW, .SS, .0

Accessories p. 116

Hydrofloor Nano Linear Wall-Washer

Linear shape ground-recessed luminaire for outdoor installation. Body in hard anodized aluminum with phospho-chromatised and polyester powder coating and frontal cover in stainless steel AISI 316L, tempered safety glass. Remote constant current 500mA driver needed, with 16 x mid-power SAMSUNG 2835 LED. IP68 rating.

209002

6W

CCT	Beam Angle	Im	Im/w	Finish	Dimming
.27 2700°K	.WW Wall Washer	450	75.00	.SS Stainless Steel	.0 ON/OFF
.30 3000°K	.WW Wall Washer	470	78.34		
.40 4000°K	.WW Wall Washer	490	81.67		

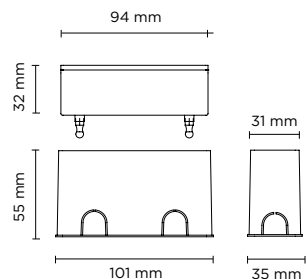

Code Example

209005, .27, .WW, .GL, .0

Accessories p. 116

Hydrofloor Nano Linear Trimless Wall-Washer

Trimless version, all other details are same as model 209002

Finish

.GL Clear Glass

209005

6W

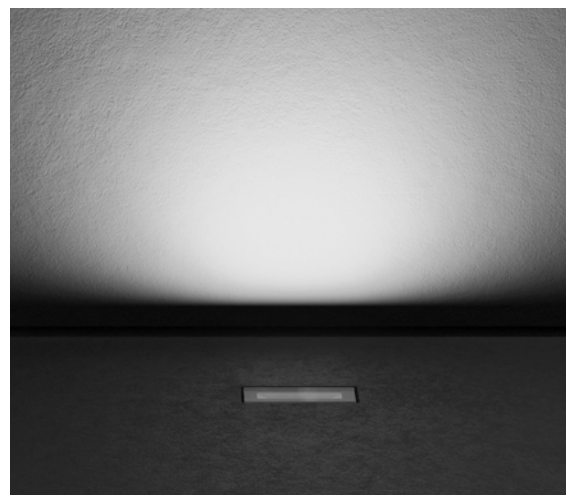

Remote Driver Selection

Brand	Manufacturer code	Type	Watt	IP Rate	Number of fixtures
ALVIT Italy	AL1450S-IP	constant current 500mA	14W	IP67	min 1 - max 2
TCI Italy	152014/500	constant current 500mA	24W	IP68	min 1 - max 3

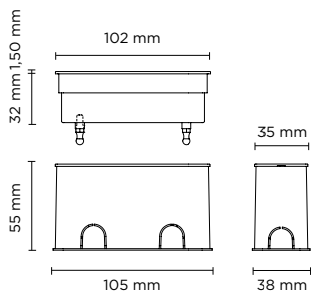

PRODUCT WEIGHT 0,50 kg



Code Example

209003.27.BL.SS.0

Accessories p. 116

Hydrofloor Nano Linear Blade

Linear shape ground-recessed luminaire for outdoor installation. Body in hard anodized aluminum with phospho-chromatised and polyester powder coating and frontal cover in stainless steel AISI 316L, tempered safety glass. Asymmetric radial beam distribution. Remote constant current max 700mA driver needed, with 3 CREE XP-G2 LED. IP68 rating.

209003

Max 6W

CCT	Beam Angle	Finish	Dimming
.27 2700°K	.BL 20°x100°	.SS Stainless Steel	.0 ON/OFF
.30 3000°K	.BL 20°x100°		
.40 4000°K	.BL 20°x100°		

CCT	Beam Angle	350 mA LED POWER 3W		500 mA LED POWER 4,5W		700 mA LED POWER 6W	
		lm	lm/w	lm	lm/w	lm	lm/w
2700°K	20°x100°	210	70.00	315	70.00	420	70.00
3000°K	20°x100°	220	73.33	330	73.33	440	73.33
4000°K	20°x100°	230	76.66	345	76.66	460	76.66

Remote Driver Selection

Brand	Manufacturer code	Type	Watt	IP Rate	Number of fixtures
ALVIT Italy	AL1435S-IP	constant current 350mA	14W	IP67	min 1 - max 4
ALVIT Italy	AL1450S-IP	constant current 500mA	14W	IP67	min 1 - max 3
ALVIT Italy	AL1470S-IP	constant current 700mA	14W	IP67	min 1 - max 2
TCI Italy	152014/350	constant current 350mA	17W	IP68	min 1 - max 5
TCI Italy	152014/500	constant current 500mA	24W	IP68	min 1 - max 5
TCI Italy	152014/700	constant current 700mA	30W	IP68	min 1 - max 4

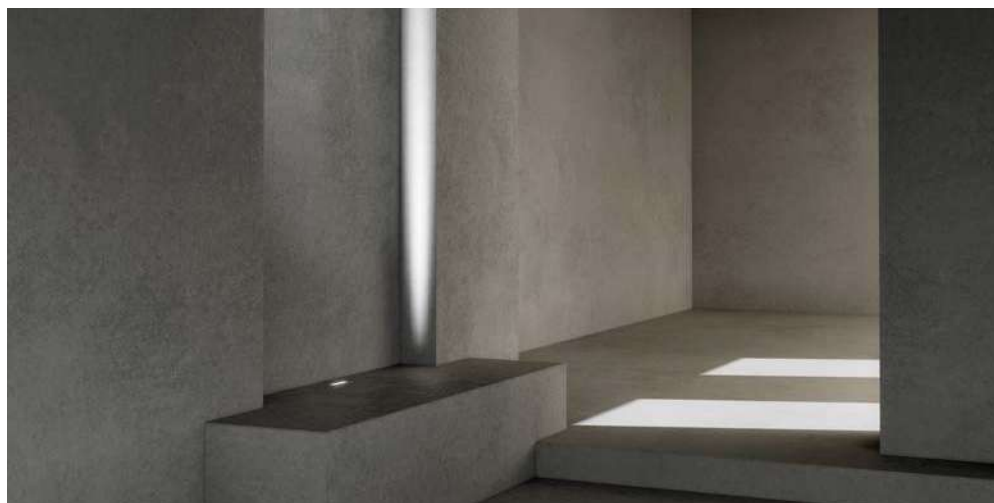

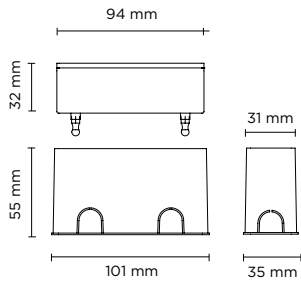

Code Example

209006.27.BL.GL.0

Accessories p. 116

Hydrofloor Nano Linear Trimless Blade

Trimless version, all other details are same as model 209003

Finish

.GL Clear Glass

209006

Max 6W

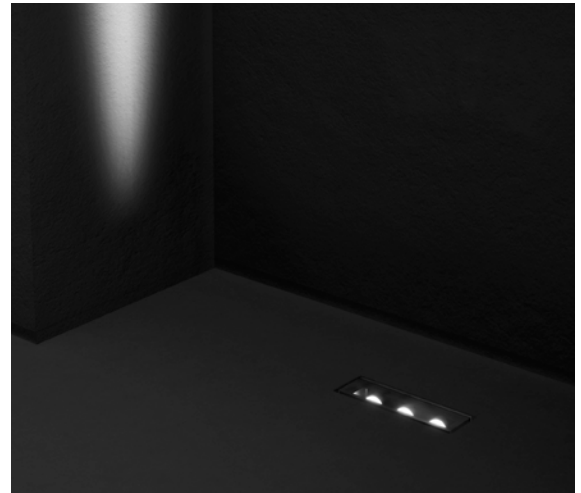

Remote Driver Selection

Brand	Manufacturer code	Type	Watt	IP Rate	Number of fixtures
ALVIT Italy	AL1435S-IP	constant current 350mA	14W	IP67	min 1 - max 4
ALVIT Italy	AL1450S-IP	constant current 500mA	14W	IP67	min 1 - max 3
ALVIT Italy	AL1470S-IP	constant current 700mA	14W	IP67	min 1 - max 2
TCI Italy	152014/350	constant current 350mA	17W	IP68	min 1 - max 5
TCI Italy	152014/500	constant current 500mA	24W	IP68	min 1 - max 5
TCI Italy	152014/700	constant current 700mA	30W	IP68	min 1 - max 4

INTEGRATED ACCESSORIES

209001.27.08.SS.0.__

Built-in accessories to be requested when ordering
example 209001.27.08.SS.0.HC

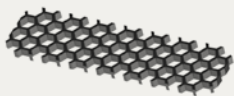

.HC

HONEYCOMB

A honeycomb structure designed to shield the light beam, reduce glare, and eliminate direct exposure to the light source.
Available for:

HYDROFLOOR NANO LINEAR HP



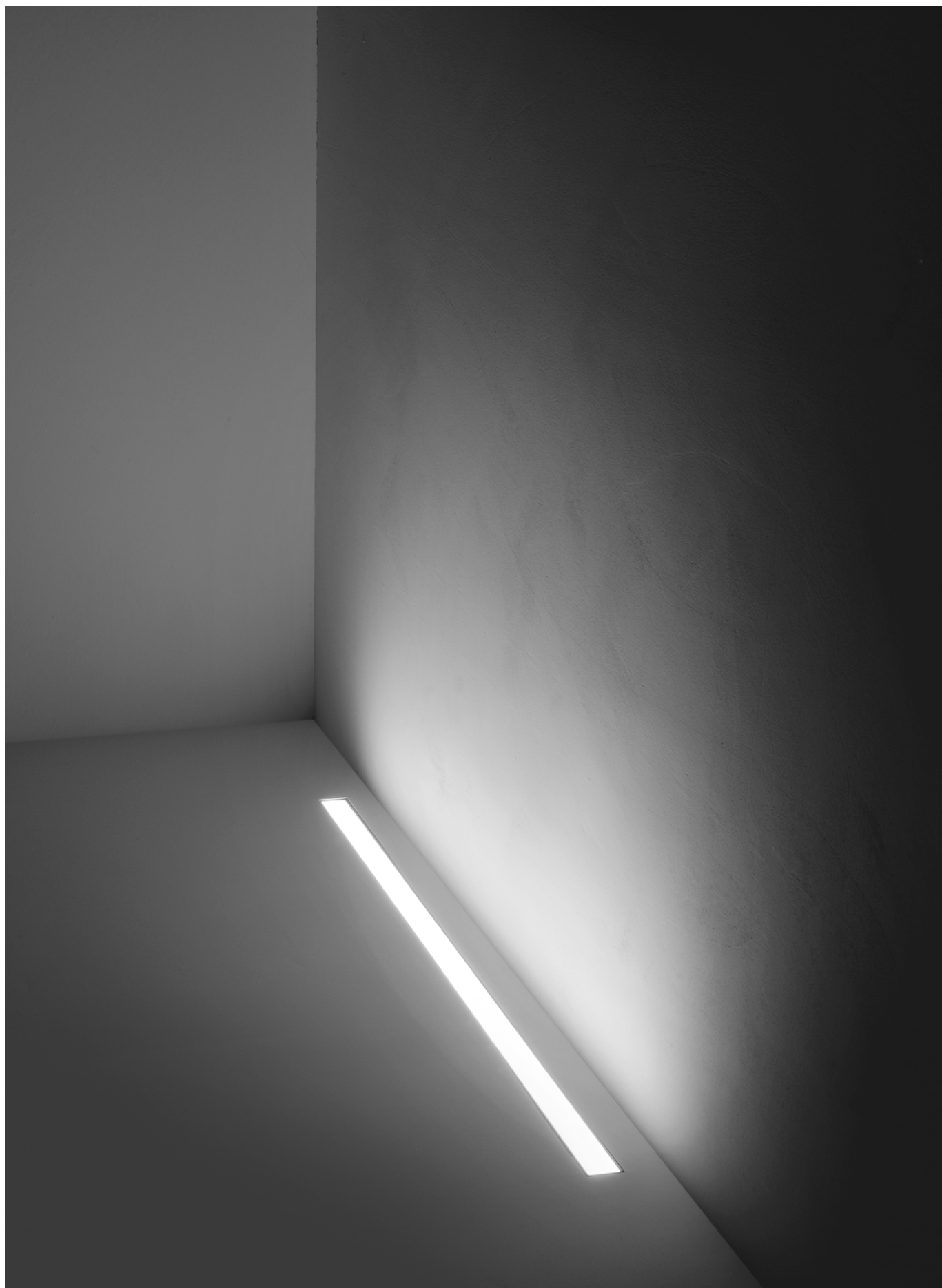

Line Vetro

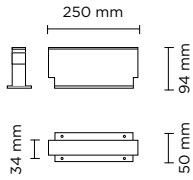

PRODUCT WEIGHT 1,00 kg



Line Vetro Slim 250

Code Example

204004·.30·.90·OP·0

Accessories p. 120

Linear slim ground-recessed luminaire for outdoor installation, length 250 mm, anodized extruded aluminum body, opal resin diffuser, anodized aluminum housing for recess. 24V DC remote driver needed, Low power 18 Epistar SMD5050 LED. IP67 rating.

204004

3,5W

CCT	Beam Angle	lm	lm/w	Finish	Dimming
.30 3000°K	.90 90°	75	21.43	.OP <input type="checkbox"/> Opal	.0 ON/OFF

Remote Driver Selection

Brand	Manufacturer code	Type	Watt	IP Rate	Number of fixtures
Meanwell	LPV-20-24	constant voltage 24V DC	20W	IP67	min 1 - max 4
Meanwell	LPV-35-24	constant voltage 24V DC	35W	IP67	min 1 - max 7

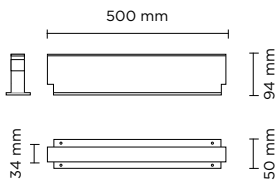

PRODUCT WEIGHT 2,10 kg



Line Vetro Slim 500

Code Example

204005·.30·.90·OP·0

Accessories p. 120

Linear slim ground-recessed luminaire for outdoor installation, length 500 mm, anodized extruded aluminum body, opal resin diffuser, anodized aluminum housing for recess. 24V DC remote driver needed, Low power 32 Epistar SMD5050 LED. IP67 rating.

204005

7W

CCT	Beam Angle	lm	lm/w	Finish	Dimming
.30 3000°K	.90 90°	150	21.43	.OP <input type="checkbox"/> Opal	.0 ON/OFF

Remote Driver Selection

Brand	Manufacturer code	Type	Watt	IP Rate	Number of fixtures
Meanwell	LPV-20-24	constant voltage 24V DC	20W	IP67	min 1 - max 2
Meanwell	LPV-35-24	constant voltage 24V DC	35W	IP67	min 1 - max 3
Meanwell	LPV-60-24	constant voltage 24V DC	60W	IP67	min 1 - max 7

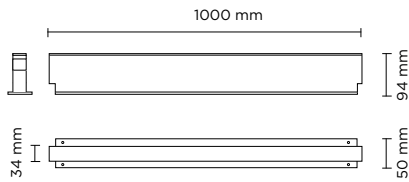

PRODUCT WEIGHT 4,20 kg



Line Vetro Slim 1000

Code Example

204003 .30 .90 .OP .0

Linear slim ground-recessed luminaire for outdoor installation, length 1.000mm, anodized extruded aluminum body, opal resin diffuser, anodized aluminum housing for recess. 24V DC remote driver needed, Low power 72 Epistar SMD5050 LED. IP67 rating.

Accessories p. 120

	CCT	Beam Angle	lm	lm/w	Finish	Dimming
204003	.30 3000°K	.90 90°	300	20.00	.OP <input type="checkbox"/> Opal	.0 ON/OFF
15W						

Remote Driver Selection

Brand	Manufacturer code	Type	Watt	IP Rate	Number of fixtures
Meanwell	LPV-20-24	constant voltage 24V DC	20W	IP67	1
Meanwell	LPV-35-24	constant voltage 24V DC	35W	IP67	min 1 - max 2
Meanwell	LPV-60-24	constant voltage 24V DC	60W	IP67	min 1 - max 3
Meanwell	LPV-100-24	constant voltage 24V DC	100W	IP67	min 1 - max 5

ACCESSORIES NOT INCLUDED

Accessories to be ordered separately.



.AC129

LEADER CABLE

Female Connector. Compatible for all products of the series.



.AC130

JUMPER CABLE

1 meter (male+female connector). Compatible for all products of the series.



.AC131

END CAP

Terminator (male). Compatible for all products of the series.

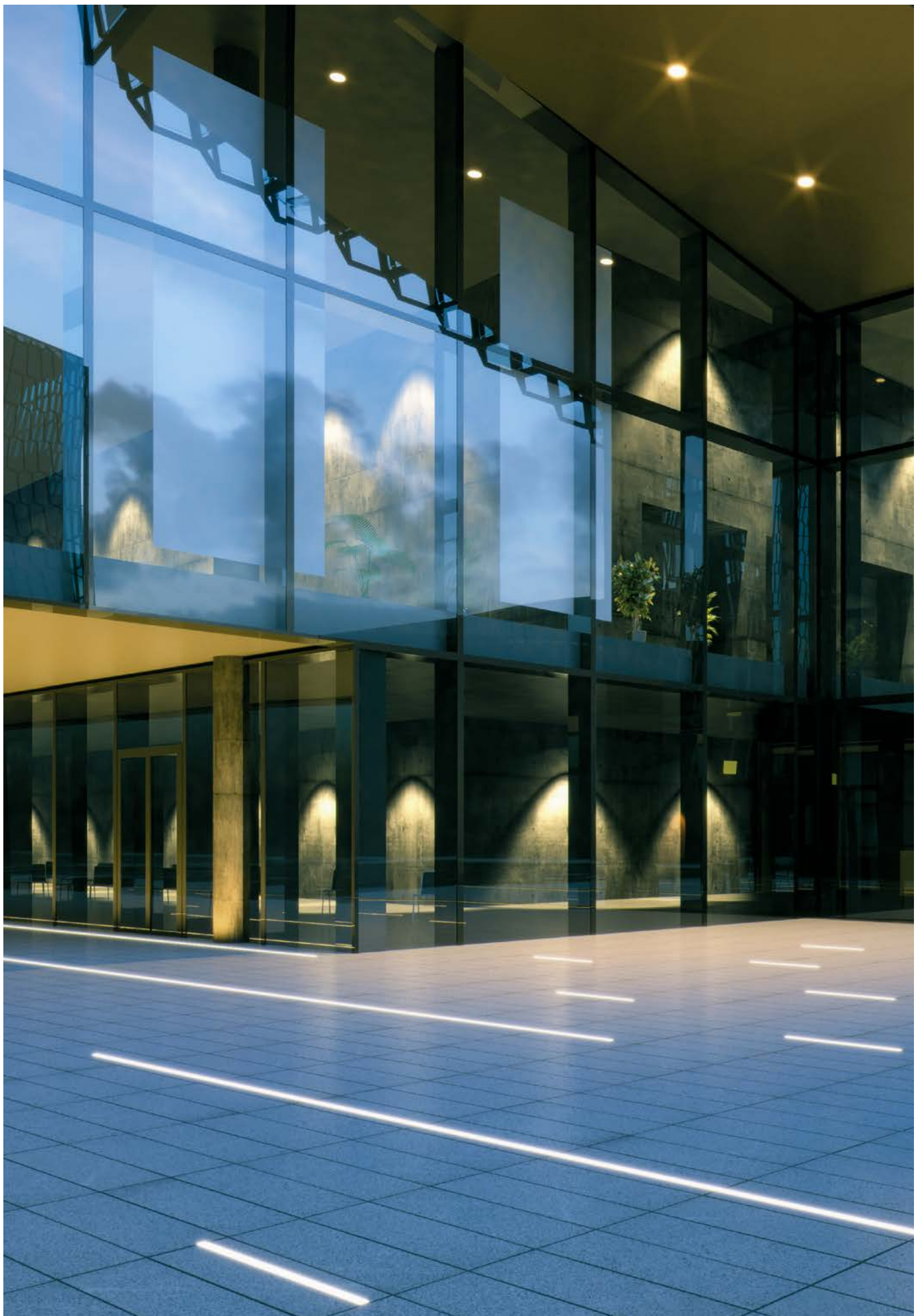

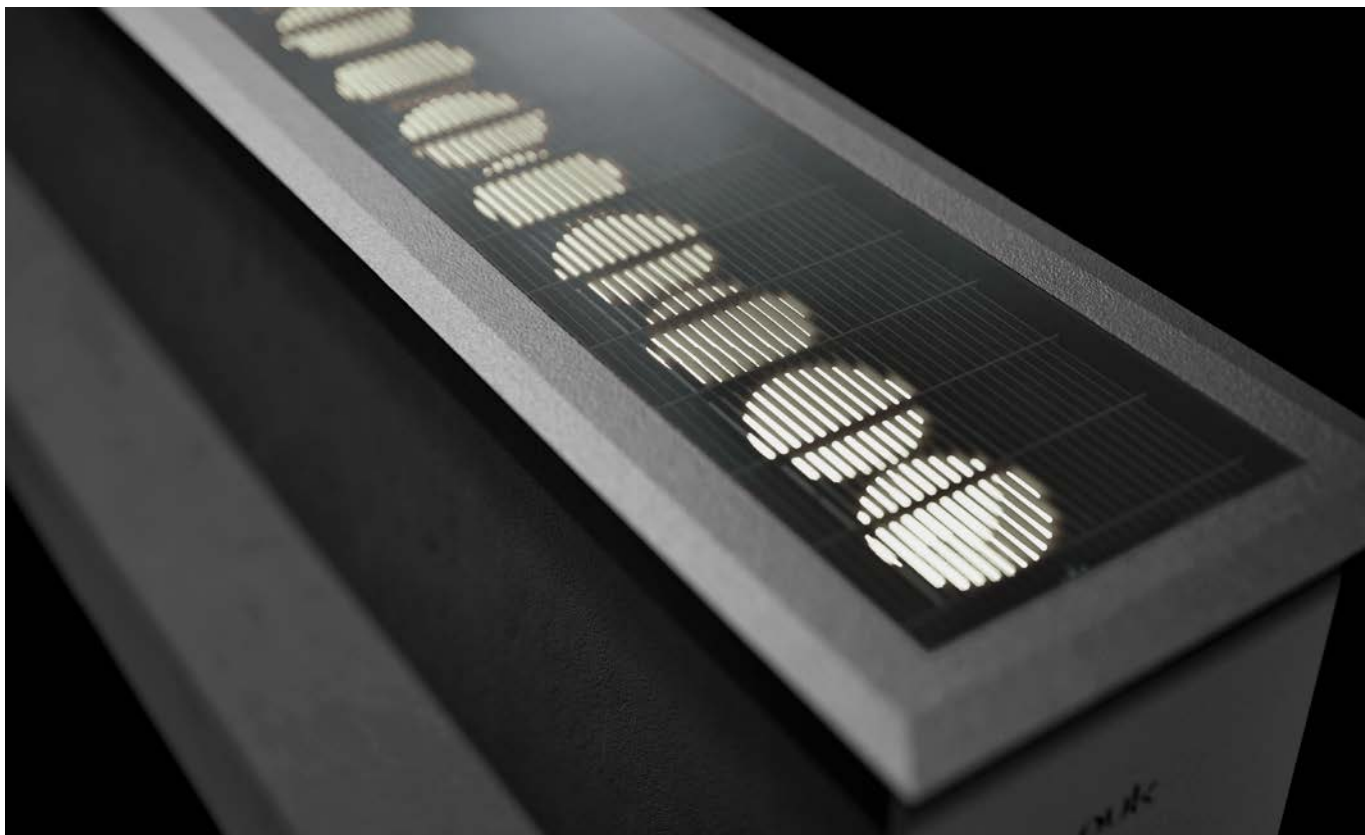

Lineaground HP

LUMINAIRE

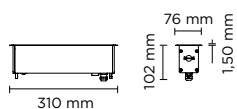

RECESS HOUSING

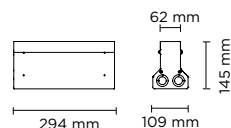

PRODUCT WEIGHT 3,00 kg

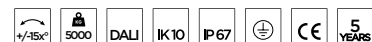

Lineaground 300 HP

Code Example

201101.27.15.01.0

Accessories p. 133

Linear shape ground-recessed luminaire for outdoor installation, length 310mm, made in phospho-chromatised and polyester powder coated extruded copper-free aluminium, with tempered safety glass, moulded silicone gaskets, extruded aluminum back box. Light source tilt system +/- 15deg from outside. Built-in LED driver 220-240V 50-60Hz, with 12 x SAMSUNG 3030 LED. IP67 rating.

201101

12W

CCT	Beam Angle	lm	lm/w
.27 2700°K	.15 15°	900	75.00
	.35 35°	870	72.50
	.55 55°	840	70.00
	.WW Asym. Wall Washer	870	72.50
.30 3000°K	.15 15°	930	77.50
	.35 35°	900	75.00
	.55 55°	870	72.50
	.WW Asym. Wall Washer	900	75.00
.40 4000°K	.15 15°	960	80.00
	.35 35°	930	77.50
	.55 55°	900	75.00
	.WW Asym. Wall Washer	930	77.50

Finish

.01 Matt Black

Dimming

.0 ON/OFF

.D DALI

LUMINAIRE

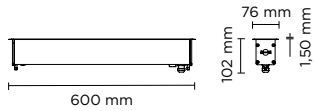

RECESS HOUSING

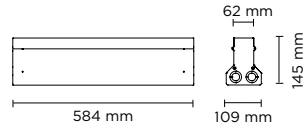

PRODUCT WEIGHT 5,50 kg



Lineaground 600 HP

Code Example

201105 .27 .15 .01 .0

Accessories p. 133

Linear shape ground-recessed luminaire for outdoor installation, length 600mm, made in phospho-chromatised and polyester powder coated extruded copper-free aluminium, with tempered safety glass, moulded silicone gaskets, extruded aluminum back box. Light source tilt system +/- 15deg from outside. Built-in LED driver 220-240V 50-60Hz, with 24 x SAMSUNG 3030 LED. IP67 rating.

201105

24W

CCT	Beam Angle	lm	lm/w	Finish	Dimming
.27 2700°K	.15 15°	1.800	75.00	.01 Matt Black	.0 ON/OFF
	.35 35°	1.740	72.50		.D DALI
	.55 55°	1.680	70.00		
	.WW <small>Asym. Wall Washer</small>	1.740	72.50		
.30 3000°K	.15 15°	1.860	77.50	.01 Matt Black	.0 ON/OFF .D DALI
	.35 35°	1.800	75.00		
	.55 55°	1.740	72.50		
	.WW <small>Asym. Wall Washer</small>	1.800	75.00		
.40 4000°K	.15 15°	1.920	80.00	.01 Matt Black	.0 ON/OFF .D DALI
	.35 35°	1.860	77.50		
	.55 55°	1.800	75.00		
	.WW <small>Asym. Wall Washer</small>	1.860	77.50		

LUMINAIRE

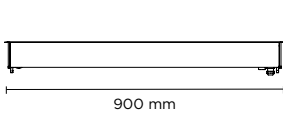

RECESS HOUSING

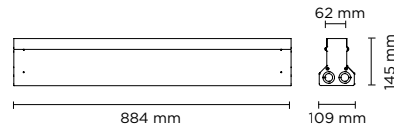

PRODUCT WEIGHT 7,00 kg



Lineaground 900 HP

Code Example

201109 .27 .15 .01 .0

Accessories p. 133

Linear shape ground-recessed luminaire for outdoor installation, length 900mm, made in phospho-chromatised and polyester powder coated extruded copper-free aluminium, with tempered safety glass, moulded silicone gaskets, extruded aluminum back box. Light source tilt system +/- 15deg from outside. Built-in LED driver 220-240V 50-60Hz, with 36 x SAMSUNG 3030 LED. IP67 rating.

201109

36W

CCT	Beam Angle	lm	lm/w	Finish	Dimming
.27 2700°K	.15 15°	2.700	75.00	.01 Matt Black	.0 ON/OFF .D DALI
	.35 35°	2.610	72.50		
	.55 55°	2.520	70.00		
	.WW <small>Asym. Wall Washer</small>	2.610	72.50		
.30 3000°K	.15 15°	2.790	77.50	.01 Matt Black	.0 ON/OFF .D DALI
	.35 35°	2.700	75.00		
	.55 55°	2.610	72.50		
	.WW <small>Asym. Wall Washer</small>	2.700	75.00		
.40 4000°K	.15 15°	2.880	80.00	.01 Matt Black	.0 ON/OFF .D DALI
	.35 35°	2.790	77.50		
	.55 55°	2.700	75.00		
	.WW <small>Asym. Wall Washer</small>	2.790	77.50		

LUMINAIRE

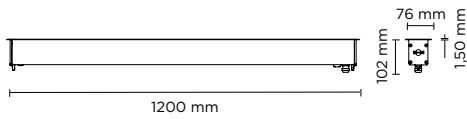

RECESS HOUSING

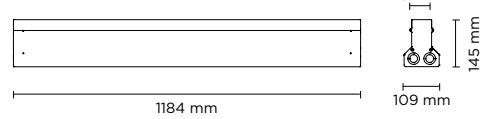

PRODUCT WEIGHT 9,50 kg





Lineaground 1200 HP

Code Example

201113 · .27 · .15 · .01 · .0

Accessories p. 133

Linear shape ground-recessed luminaire for outdoor installation, length 1200mm, made in phosphochromatised and polyester powder coated extruded copper-free aluminium, with tempered safety glass, moulded silicone gaskets, extruded aluminum back box. Light source tilt system +/- 15deg from outside. Built-in LED driver 220-240V 50-60Hz, with 48 x SAMSUNG 3030 LED. IP67 rating.

CCT	Beam Angle	lm	lm/w	Finish	Dimming
201113 48W	.27 2700°K	.15 15°	3.600 75.00	.01  Matt Black	.0 ON/OFF .D DALI
		.35 35°	3.480 72.50		
		.55 55°	3.360 70.00		
		.WW <small>Asym. Wall Washer</small>	3.480 72.50		
.30 3000°K	.15 15°	3.720 77.50	.01  Matt Black	.0 ON/OFF .D DALI	
		.35 35°			3.600 75.00
		.55 55°			3.480 72.50
		.WW <small>Asym. Wall Washer</small>			3.600 75.00
.40 4000°K	.15 15°	3.840 80.00	.01  Matt Black	.0 ON/OFF .D DALI	
		.35 35°			3.720 77.50
		.55 55°			3.600 75.00
		.WW <small>Asym. Wall Washer</small>			3.720 77.50

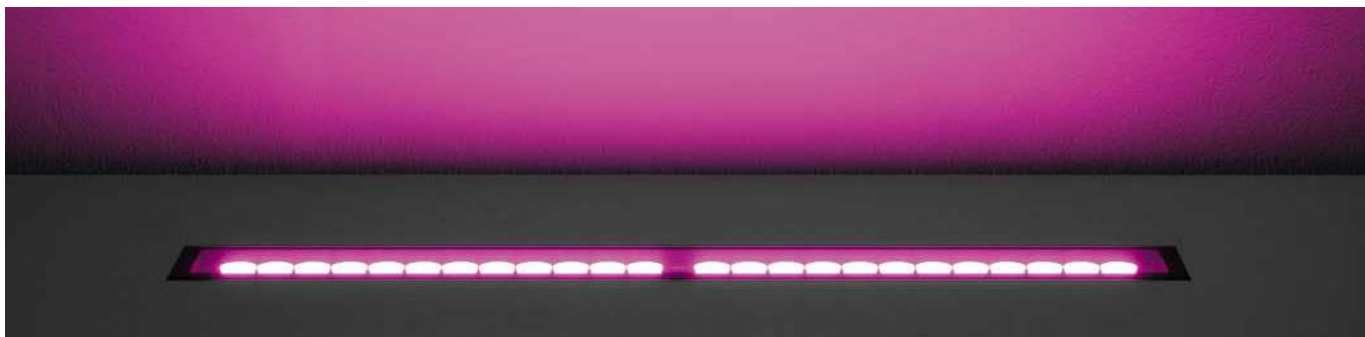

Lineaground RGBW

LUMINAIRE

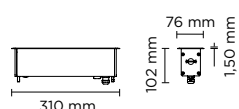

RECESS HOUSING

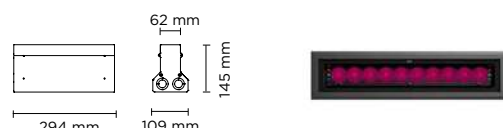

PRODUCT WEIGHT 3,00 kg



Lineaground 300 HP DMX RGBW

Code Example

201102.RW.15.01.D

Accessories p. 133

Linear shape ground-recessed luminaire for outdoor installation, length 310mm, made in phospho-chromatised and polyester powder coated extruded copper-free aluminium, with tempered safety glass, moulded silicone gaskets, extruded aluminum back box. Light source tilt system +/- 15deg from outside. Remote 24V DC power supply needed, DMX interface integrated, with 12 x RGBW(3000K) 3535 LED. IP67 rating.

201102

10W

CCT	Beam Angle	lm	lm/w
.RW RGBW	.15 15°	380	38.00
	.30 30°	365	36.50
	.60 60°	335	33.50
	.E6 10X60° elliptical	365	36.50

Finish

.01 Matt Black

Dimming

.D DALI

.X DMX

LUMINAIRE

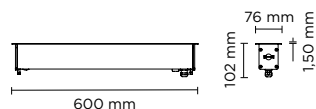

RECESS HOUSING



PRODUCT WEIGHT 5,50 kg



Lineaground 600 HP DMX RGBW

Code Example

201106.RW.15.01.D

Accessories p. 133

Linear shape ground-recessed luminaire for outdoor installation, length 600mm, made in phospho-chromatised and polyester powder coated extruded copper-free aluminium, with tempered safety glass, moulded silicone gaskets, extruded aluminum back box. Light source tilt system +/- 15deg from outside. Built-in LED driver 220-240V 50-60Hz, DMX interface integrated, with 24 x RGBW(3000K) 3535 LED. IP67 rating.

201106

20W

CCT	Beam Angle	lm	lm/w
.RW RGBW	.15 15°	760	38.00
	.30 30°	730	36.50
	.60 60°	670	33.50
	.E6 10X60° elliptical	730	36.50

Finish

.01 Matt Black

Dimming

.D DALI

.X DMX

LUMINAIRE

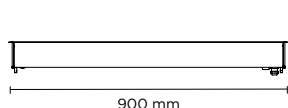

RECESS HOUSING

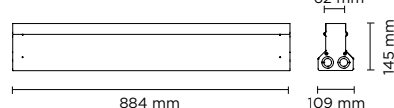

PRODUCT WEIGHT 7,00 kg



Lineaground 900 HP DMX RGBW

Code Example

201110·RW·15·01·D

Accessories p. 133

Linear shape ground-recessed luminaire for outdoor installation, length 900mm, made in phospho-chromatised and polyester powder coated extruded copper-free aluminium, with tempered safety glass, moulded silicone gaskets, extruded aluminum back box. Light source tilt system +/- 15deg from outside. Built-in LED driver 220-240V 50-60Hz, DMX interface integrated, with 36 x RGBW(3000K) 3535 LED. IP67 rating.

201110
30W

CCT	Beam Angle	lm	lm/w	Finish	Dimming
.RW RGBW	.15 15°	1.140	38.00	.01 Matt Black	.D DALI
	.30 30°	1.095	36.50		.X DMX
	.60 60°	1.005	33.50		
	.E6 10X60° elliptical	1.095	36.50		

LUMINAIRE

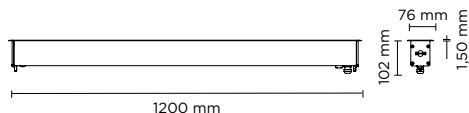

RECESS HOUSING

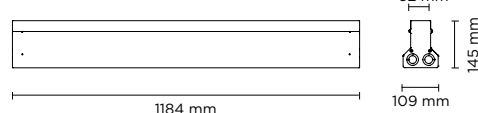

PRODUCT WEIGHT 9,50 kg



Lineaground 1200 HP DMX RGBW

Code Example

201114·RW·15·01·D

Accessories p. 133

Linear shape ground-recessed luminaire for outdoor installation, length 1200mm, made in phospho-chromatised and polyester powder coated extruded copper-free aluminium, with tempered safety glass, moulded silicone gaskets, extruded aluminum back box. Light source tilt system +/- 15deg from outside. Built-in LED driver 220-240V 50-60Hz, DMX interface integrated, with 48 x RGBW(3000K) 3535 LED. IP67 rating.

201114
40W

CCT	Beam Angle	lm	lm/w	Finish	Dimming
.RW RGBW	.15 15°	1.520	38.00	.01 Matt Black	.D DALI
	.30 30°	1.460	36.50		.X DMX
	.60 60°	1.340	33.50		
	.E6 10X60° elliptical	1.460	36.50		

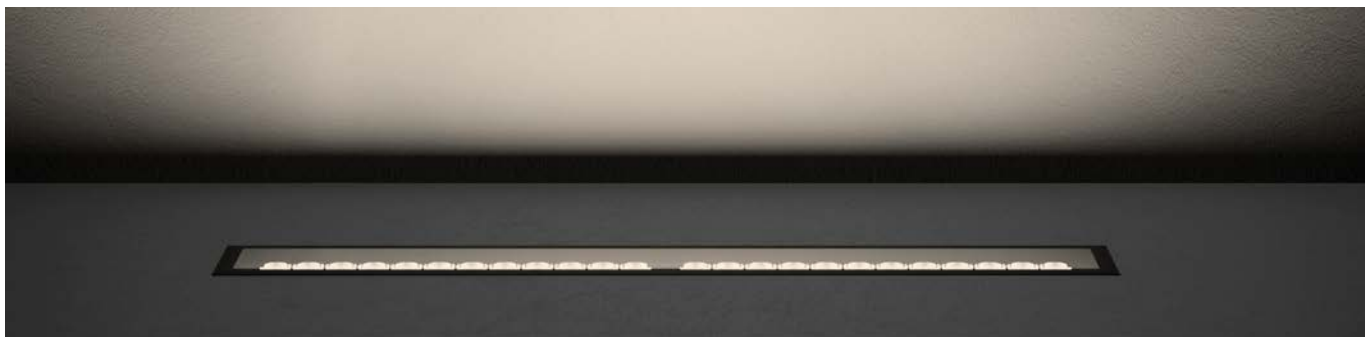

Lineaground Tunable-White

LUMINAIRE

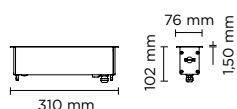

RECESS HOUSING

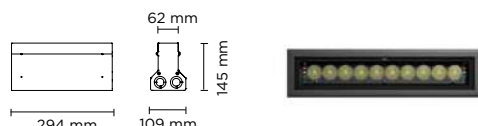

PRODUCT WEIGHT 3,00 kg



Lineaground 300 HP DMX Tunable-White

Code Example

201103.TW.15.01.D

Accessories p. 133

Linear shape ground-recessed luminaire for outdoor installation, length 310mm, made in phospho-chromatised and polyester powder coated extruded copper-free aluminium, with tempered safety glass, moulded silicone gaskets, extruded aluminum back box. Light source tilt system +/- 15deg from outside. Remote 24V DC power supply needed, DMX interface integrated, with 12 x Tunable White 3535 LED (2700K-5600K). IP67 rating.

201103
10W

CCT	Beam Angle	lm	lm/w
.TW 2700°K 5600°K	.15 15°	650	65.00
	.30 30°	635	63.50
	.60 60°	620	62.00
	.E6 10X60° elliptical	635	63.50

Finish	Dimming
.01 Matt Black	.D DALI .X DMX

LUMINAIRE

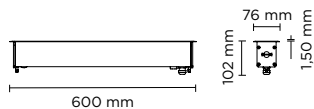

RECESS HOUSING



PRODUCT WEIGHT 5,50 kg



Lineaground 600 HP DMX Tunable-White

Code Example

201107.TW.15.01.D

Accessories p. 133

Linear shape ground-recessed luminaire for outdoor installation, length 600mm, made in phospho-chromatised and polyester powder coated extruded copper-free aluminium, with tempered safety glass, moulded silicone gaskets, extruded aluminum back box. Light source tilt system +/- 15deg from outside. Built-in LED driver 220-240V 50-60Hz, DMX interface integrated, with 24 x Tunable White 3535 LED (2700K-5600K). IP67 rating.

201107
20W

CCT	Beam Angle	lm	lm/w
.TW 2700°K 5600°K	.15 15°	1.300	65.00
	.30 30°	1.270	63.50
	.60 60°	1.240	62.00
	.E6 10X60° elliptical	1.270	63.50

Finish	Dimming
.01 Matt Black	.D DALI .X DMX

LUMINAIRE

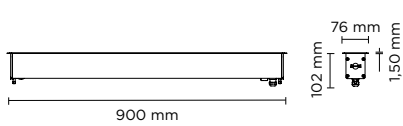

RECESS HOUSING

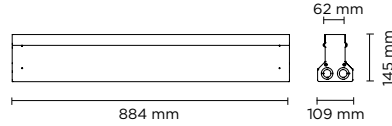

PRODUCT WEIGHT 7,00 kg



Lineaground 900 HP DMX Tunable-White

Code Example

20111 J .TW J .15 J .01 J .D

Accessories p. 133

Linear shape ground-recessed luminaire for outdoor installation, length 900mm, made in phosphochromatised and polyester powder coated extruded copper-free aluminium, with tempered safety glass, moulded silicone gaskets, extruded aluminum back box. Light source tilt system +/- 15deg from outside. Built-in LED driver 220-240V 50-60Hz, DMX interface integrated, with 36 x Tunable White 3535 LED (2700K-5600K). IP67 rating.

CCT	Beam Angle	Im	Im/w	Finish	Dimming	
					.D	.X
.TW 2700°K 5600°K	.15 15°	1.950	65.00	.01 Matt Black	.D	DALI
	.30 30°	1.905	63.50		.X	DMX
	.60 60°	1.860	62.00			
	.E6 10X60° elliptical	1.905	63.50			

20111
30W

LUMINAIRE

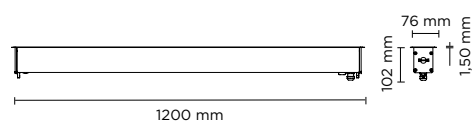

RECESS HOUSING

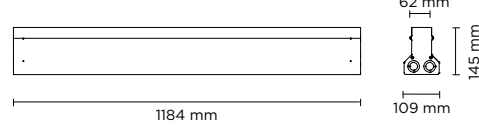

PRODUCT WEIGHT 9,50 kg



Lineaground 1200 HP DMX Tunable-White

Code Example

201115 J .TW J .15 J .01 J .D

Accessories p. 133

Linear shape ground-recessed luminaire for outdoor installation, length 1200mm, made in phosphochromatised and polyester powder coated extruded copper-free aluminium, with tempered safety glass, moulded silicone gaskets, extruded aluminum back box. Light source tilt system +/- 15deg from outside. Built-in LED driver 220-240V 50-60Hz, DMX interface integrated, with 48 x Tunable White 3535 LED (2700K-5600K). IP67 rating.

CCT	Beam Angle	Im	Im/w	Finish	Dimming	
					.D	.X
.TW 2700°K 5600°K	.15 15°	2.600	65.00	.01 Matt Black	.D	DALI
	.30 30°	2.540	63.50		.X	DMX
	.60 60°	2.480	62.00			
	.E6 10X60° elliptical	2.540	63.50			

201115
40W

Lineaground Diffused

LUMINAIRE

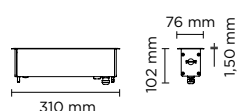

RECESS HOUSING



PRODUCT WEIGHT 3,00 kg

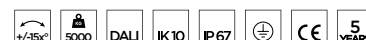

Code Example

201104 .27 .DF .01 .0

Accessories p. 133

Lineaground 300 Diffused

Linear shape ground-recessed luminaire for outdoor installation, length 310mm, made in phospho-chromatised and polyester powder coated extruded copper-free aluminium, with tempered safety glass, moulded silicone gaskets, extruded aluminum back box. Light source tilt system +/- 15deg from outside. Built-in LED driver 220-240V 50-60Hz, with 12 x SAMSUNG 3030 LED. IP67 rating.

201104

8W

CCT	Beam Angle	lm	lm/w	Finish	Dimming
.27 2700°K	.DF Diffused	300	37.50	.01 Matt Black	.0 ON/OFF .D DALI
.30 3000°K	.DF Diffused	310	38.75		
.40 4000°K	.DF Diffused	330	41.25		

LUMINAIRE

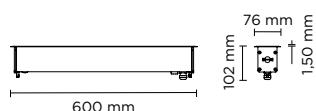

RECESS HOUSING



PRODUCT WEIGHT 5,50 kg

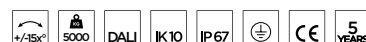

Code Example

201108 .27 .DF .01 .0

Accessories p. 133

Lineaground 600 Diffused

Linear shape ground-recessed luminaire for outdoor installation, length 600mm, made in phospho-chromatised and polyester powder coated extruded copper-free aluminium, with tempered safety glass, moulded silicone gaskets, extruded aluminum back box. Light source tilt system +/- 15deg from outside. Built-in LED driver 220-240V 50-60Hz, with 24 x SAMSUNG 3030 LED. IP67 rating.

201108

12W

CCT	Beam Angle	lm	lm/w	Finish	Dimming
.27 2700°K	.DF Diffused	500	41.66	.01 Matt Black	.0 ON/OFF .D DALI
.30 3000°K	.DF Diffused	520	43.33		
.40 4000°K	.DF Diffused	550	45.83		

LUMINAIRE

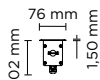
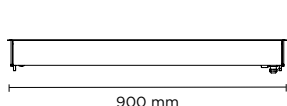

RECESS HOUSING

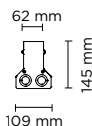
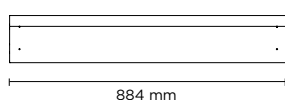

PRODUCT WEIGHT 7,00 kg

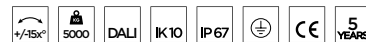

Lineaground 900 Diffused

Code Example

201112 · .27 · .DF · .01 · .O

Accessories p. 133

Linear shape ground-recessed luminaire for outdoor installation, length 900mm, made in phospho-chromatised and polyester powder coated extruded copper-free aluminium, with tempered safety glass, moulded silicone gaskets, extruded aluminum back box. Light source tilt system +/- 15deg from outside. Built-in LED driver 220-240V 50-60Hz, with 36 x SAMSUNG 3030 LED. IP67 rating.

	CCT	Beam Angle	lm	lm/w	Finish	Dimming	
201112 17W	.27	2700°K	.DF Diffused	780	45.88	.01 Matt Black	.O ON/OFF
	.30	3000°K	.DF Diffused	800	47.06		.D DALI
	.40	4000°K	.DF Diffused	830	48.80		

LUMINAIRE

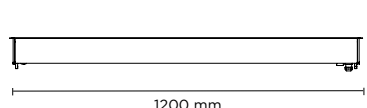

RECESS HOUSING

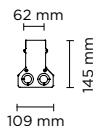
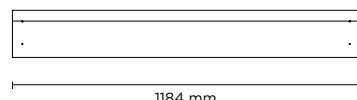

PRODUCT WEIGHT 9,50 kg

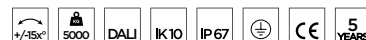

Lineaground 1200 Diffused

Code Example

201116 · .27 · .DF · .01 · .O

Accessories p. 133

Linear shape ground-recessed luminaire for outdoor installation, length 1200mm, made in phospho-chromatised and polyester powder coated extruded copper-free aluminium, with tempered safety glass, moulded silicone gaskets, extruded aluminum back box. Light source tilt system +/- 15deg from outside. Built-in LED driver 220-240V 50-60Hz, with 48 x SAMSUNG 3030 LED. IP67 rating.

	CCT	Beam Angle	lm	lm/w	Finish	Dimming	
201116 24W	.27	2700°K	.DF Diffused	1.010	42.08	.01 Matt Black	.O ON/OFF
	.30	3000°K	.DF Diffused	1.050	43.75		.D DALI
	.40	4000°K	.DF Diffused	1.100	45.83		

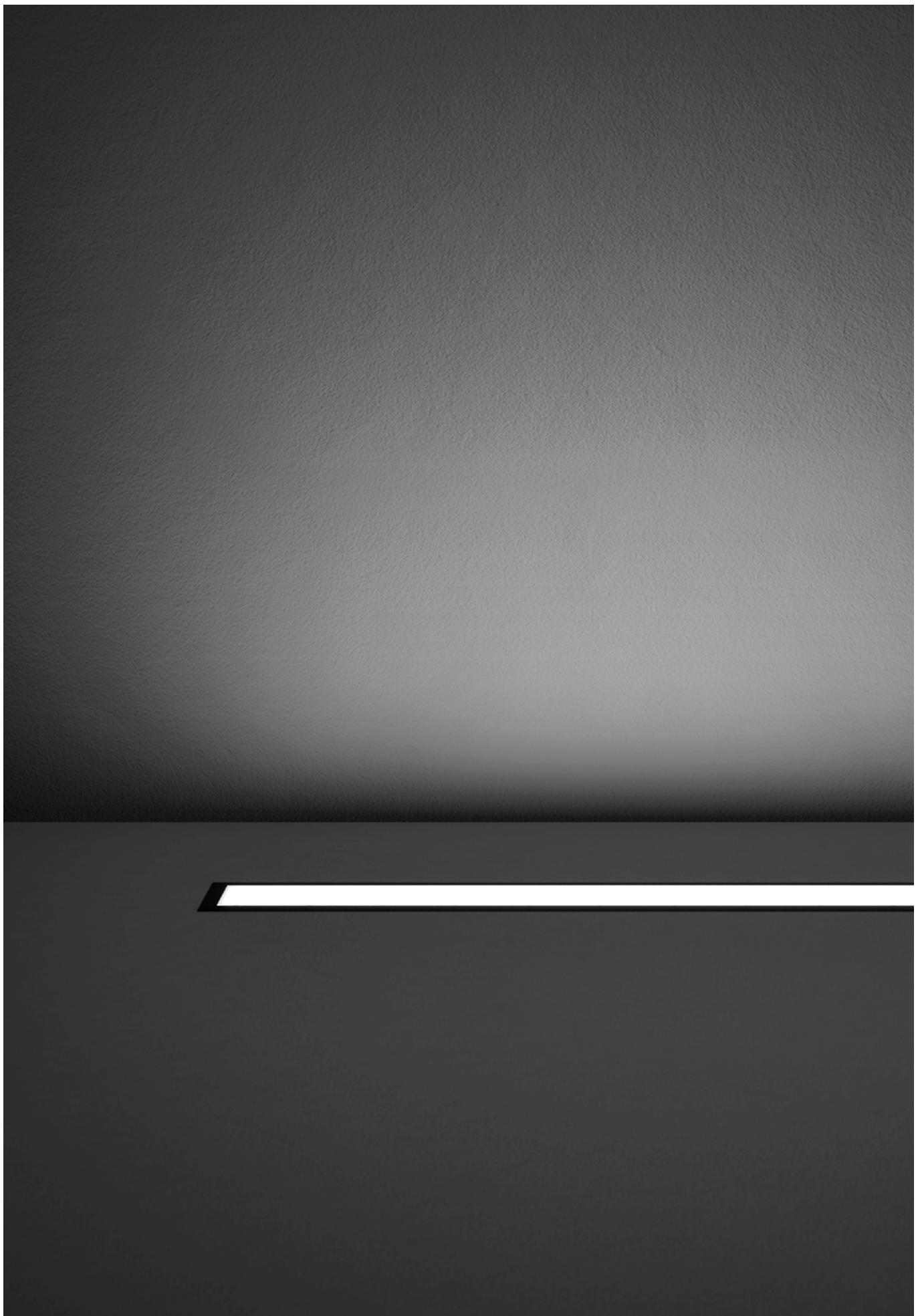

PRODUCT OVERVIEW

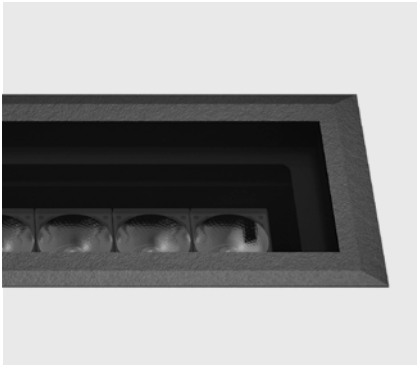

NO EXPOSED SCREWS ONCE THE PRODUCT IS INSTALLED

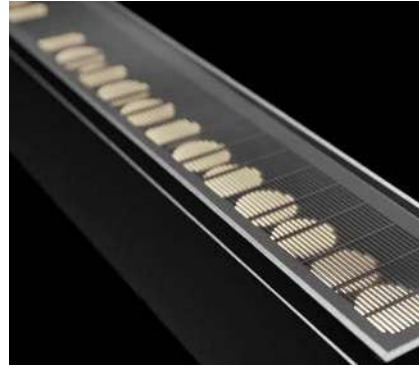

PLENTY OF SOLUTIONS AS ANTI-GLARE ACCESSORIES



only 12 mm
REDUCED WIDTH AT 12 MM FOR BETTER AESTHETIC IMPACT



VARIETY OF LIGHT SOURCE & MODELS



SPECIAL TILT SYSTEM INTEGRATED ALLOWING ON SITE ADJUSTMENT +/- 15 DEG WITHOUT OPENING THE LUMINAIRE

LIGHT BEAM OPTIONS

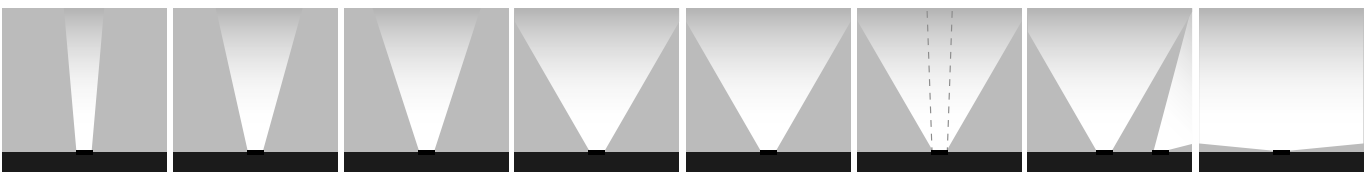

NARROW 15° MEDIUM 30° MEDIUM WIDE 35° WIDE FLOOD 55° WIDE FLOOD 60° 10x60° ELLIPTICAL ASYMMETRIC WALL-WASHER DIFFUSED

Lineaground "Continuous Line" System

201100

EXAMPLE OF A 3 UNITS SYSTEM

201105L
Linea ground 600HP - LEFT

201105X
Linea ground 600HP -
INTERMEDIATE

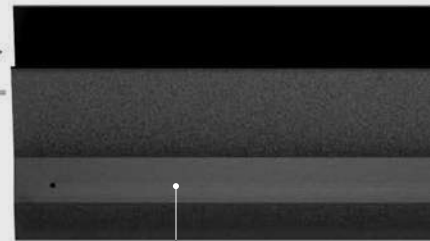

Recessed housing
included with
201105L

Recessed housing
included with
201105L

Alignment kit
included with
any lineaground
"continuous
line" model

201105R
Linea ground 600HP - RIGHT



Alignment kit
included with
any lineaground
"continuous
line" model

Recessed housing
included with 201105L



Lineaground “Continuous Line” System

201100

201101L	Lineaground 300 Hp - Left	201106R	Lineaground 600 Hp Dmx Rgbw - Right
201101R	Lineaground 300 Hp - Right	201106X	Lineaground 600 Hp Dmx Rgbw - Intermediate
201101X	Lineaground 300 Hp - Intermediate	201107L	Lineaground 600 Hp Dmx Tunable-White - Left
201102L	Lineaground 300 Hp Dmx Rgbw - Left	201107R	Lineaground 600 Hp Dmx Tunable-White - Right
201102R	Lineaground 300 Hp Dmx Rgbw - Right	201107X	Lineaground 600 Hp Dmx Tunable-White Intermediate
201102X	Lineaground 300 Hp Dmx Rgbw - Intermediate	201108L	Lineaground 600 Diffused - Left
201103L	Lineaground 300 Hp Dmx Tunable-White - Left	201108R	Lineaground 600 Diffused - Right
201103R	Lineaground 300 Hp Dmx Tunable-White - Right	201108X	Lineaground 600 Diffused Intermediate
201103X	Lineaground 300 Hp Dmx Tunable-White Intermediate	201109L	Lineaground 900 Hp - Left
201104L	Lineaground 300 Diffused - Left	201109R	Lineaground 900 Hp - Right
201104R	Lineaground 300 Diffused - Right	201109X	Lineaground 900 Hp - Intermediate
201104X	Lineaground 300 Diffused - Intermediate	201110L	Lineaground 900 Hp Dmx Rgbw - Left
201105L	Lineaground 600 Hp - Left	201110R	Lineaground 900 Hp Dmx Rgbw - Right
201105R	Lineaground 600 Hp - Right	201110X	Lineaground 900 Hp Dmx Rgbw Intermediate
201105X	Lineaground 600 Hp - Intermediate	201111L	Lineaground 900 Hp Dmx Tunable-White - Left
201106L	Lineaground 600 Hp Dmx Rgbw - Left	201111R	Lineaground 900 Hp Dmx Tunable-White - Right



ACCESSORIES

ACCESSORIES LINEAGROUND LINEAGROUND TRIMLESS LINEAGROUND CONTINUOUS LINE

201111X	Lineaground 900 Hp Dmx Tunable-White Intermediate
201112L	Lineaground 900 Diffused - Left
201112R	Lineaground 900 Diffused - Right
201112X	Lineaground 900 Diffused - Intermediate
201113L	Lineaground 1200 Hp - Left
201113R	Lineaground 1200 Hp - Right
201113X	Lineaground 1200 Hp - Intermediate
201114L	Lineaground 1200 Hp Dmx Rgbw - Left
201114R	Lineaground 1200 Hp Dmx Rgbw - Right
201114X	Lineaground 1200 Hp Dmx Rgbw - Intermediate
201115L	Lineaground 1200 Hp Dmx Tunable-White Left
201115R	Lineaground 1200 Hp Dmx Tunable-White - Right
201115X	Lineaground 1200 Hp Dmx Tunable-White Intermediate
201116L	Lineaground 1200 Diffused - Left
201116R	Lineaground 1200 Diffused - Right
201116X	Lineaceiling 1200 Diffused - Intermediate

.ML	Microouvre 300. Built-in accessories to be requested when ordering example 201101.27.15.01.0. ML
.ML	Microouvre 600. Built-in accessories to be requested when ordering example 201105.27.15.01.0. ML
.ML	Microouvre 900. Built-in accessories to be requested when ordering example 201109.27.15.01.0. ML
.ML	Microouvre 1200. Built-in accessories to be requested when ordering example 201113.27.15.01.0. ML
AC133	Feed Cable 1 Mt. On/Off
AC134	Feed Cable 1 Mt. DALI
AC135	Jumper Cable 2 Mt. On/Off
AC136	Jumper Cable 2 Mt. DALI
AC137	Jumper Cable 4 Mt. On/Off
AC138	Jumper Cable 4 Mt. DALI
AC139	End Cap On/Off
AC140	End Cap DALI



Lineaground Trimless HP

LUMINAIRE



RECESS HOUSING

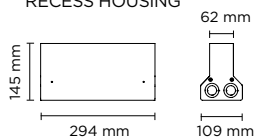

PRODUCT WEIGHT 3,00 kg

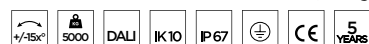

Code Example

201201.**27**.**15**.**GL**.**0**

Accessories p. 149

Lineaground 300 Trimless HP

Trimless version of linear shape ground-recessed luminaire for outdoor installation, length 294mm, made in phospho-chromatised and polyester powder coated extruded copper-free aluminium, with tempered safety glass, moulded silicone gaskets, extruded aluminum back box. Light source tilt system +/- 15deg from outside. Built-in LED driver 220-240V 50-60Hz, with 12 x SAMSUNG 3030 LED. IP67 rating.

201201

12W

CCT	Beam Angle	lm	lm/w
.27 2700°K	.15 15°	900	75.00
	.35 35°	870	72.50
	.55 55°	840	70.00
	.WW Asym. Wall Washer	870	72.50
.30 3000°K	.15 15°	930	77.50
	.35 35°	900	75.00
	.55 55°	870	72.50
	.WW Asym. Wall Washer	900	75.00
.40 4000°K	.15 15°	960	80.00
	.35 35°	930	77.50
	.55 55°	900	75.00
	.WW Asym. Wall Washer	930	77.50

Finish

.GL Clear Glass

Dimming

.0 ON/OFF

.D DALI

LUMINAIRE

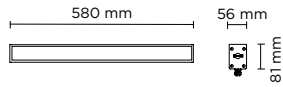

RECESS HOUSING



PRODUCT WEIGHT 5,50 kg



Lineaground 600 Trimless HP

Code Example

201205 .27 .15 .GL .0

Accessories p. 149

Trimless version of linear shape ground-recessed luminaire for outdoor installation, length 590mm, made in phospho-chromatised and polyester powder coated extruded copper-free aluminium, with tempered safety glass, moulded silicone gaskets, extruded aluminum back box. Light source tilt system +/- 15deg from outside. Built-in LED driver 220-240V 50-60Hz, with 24 x SAMSUNG 3030 LED. IP67 rating.

201205

24W

CCT	Beam Angle	Im	Im/w	Finish	Dimming
.27 2700°K	.15 15°	1.800	75.00	.GL <input type="checkbox"/> Clear Glass	.0 ON/OFF
	.35 35°	1.740	72.50		.D DALI
	.55 55°	1.680	70.00		
	.WW Asym. Wall Washer	1.740	72.50		
.30 3000°K	.15 15°	1.860	77.50	.GL <input type="checkbox"/> Clear Glass	.0 ON/OFF
	.35 35°	1.800	75.00		
	.55 55°	1.740	72.50		
	.WW Asym. Wall Washer	1.800	75.00		
.40 4000°K	.15 15°	1.920	80.00	.GL <input type="checkbox"/> Clear Glass	.0 ON/OFF
	.35 35°	1.860	77.50		
	.55 55°	1.800	75.00		
	.WW Asym. Wall Washer	1.860	77.50		

LUMINAIRE

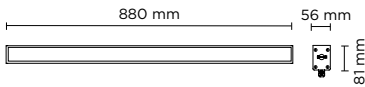

RECESS HOUSING

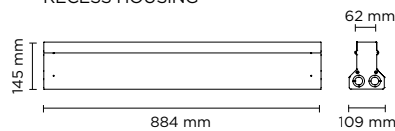

PRODUCT WEIGHT 7,00 kg



Lineaground Trimless 900 HP

Code Example

201209 .27 .15 .GL .0

Accessories p. 149

Trimless version of linear shape ground-recessed luminaire for outdoor installation, length 890mm, made in phospho-chromatised and polyester powder coated extruded copper-free aluminium, with tempered safety glass, moulded silicone gaskets, extruded aluminum back box. Light source tilt system +/- 15deg from outside. Built-in LED driver 220-240V 50-60Hz, with 36 x SAMSUNG 3030 LED. IP67 rating.

201209

36W

CCT	Beam Angle	Im	Im/w	Finish	Dimming	
.27 2700°K	.15 15°	2.700	75.00	.GL <input type="checkbox"/> Clear Glass	.0 ON/OFF	
	.35 35°	2.610	72.50			.D DALI
	.55 55°	2.520	70.00			
	.WW Asym. Wall Washer	2.610	72.50			
.30 3000°K	.15 15°	2.790	77.50	.GL <input type="checkbox"/> Clear Glass	.0 ON/OFF	
	.35 35°	2.700	75.00			
	.55 55°	2.610	72.50			
	.WW Asym. Wall Washer	2.700	75.00			
.40 4000°K	.15 15°	2.880	80.00	.GL <input type="checkbox"/> Clear Glass	.0 ON/OFF	
	.35 35°	2.790	77.50			
	.55 55°	2.700	75.00			
	.WW Asym. Wall Washer	2.790	77.50			

LUMINAIRE

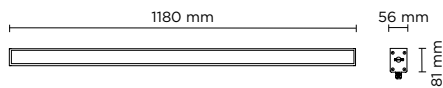

RECESS HOUSING

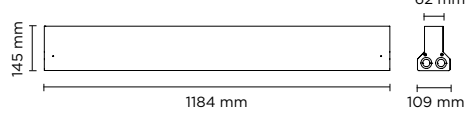

PRODUCT WEIGHT 9,50 kg



Lineaground 1200 Trimless HP

Code Example

201213 .27 .15 .GL .0

Accessories p. 149

Trimless version of linear shape ground-recessed luminaire for outdoor installation, length 1190mm, made in phospho-chromatised and polyester powder coated extruded copper-free aluminium, with tempered safety glass, moulded silicone gaskets, extruded aluminium back box. Light source tilt system +/- 15deg from outside. Built-in LED driver 220-240V 50-60Hz, with 48 x SAMSUNG 3030 LED. IP67 rating.

201213
48W

CCT	Beam Angle	lm	lm/w
.27 2700°K	.15 15°	3.600	75.00
	.35 35°	3.480	72.50
	.55 55°	3.360	70.00
	.WW <small>Asym. Wall Washer</small>	3.480	72.50
.30 3000°K	.15 15°	3.720	77.50
	.35 35°	3.600	75.00
	.55 55°	3.480	72.50
	.WW <small>Asym. Wall Washer</small>	3.600	75.00
.40 4000°K	.15 15°	3.840	80.00
	.35 35°	3.720	77.50
	.55 55°	3.600	75.00
	.WW <small>Asym. Wall Washer</small>	3.720	77.50

Finish

.GL Clear Glass

Dimming

.0 ON/OFF

.D DALI



Lineaground Trimless RGBW

LUMINAIRE

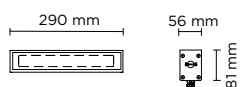

RECESS HOUSING

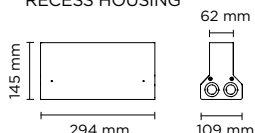

PRODUCT WEIGHT 3,00 kg



Lineaground 300 Trimless HP DMX RGBW

Code Example

201202.RW.15.GL.D

Accessories p. 149

Trimless version of linear shape ground-recessed luminaire for outdoor installation, length 294mm, made in phospho-chromatised and polyester powder coated extruded copper-free aluminium, with tempered safety glass, moulded silicone gaskets, extruded aluminum back box. Light source tilt system +/- 15deg from outside. Remote 24V DC power supply needed, DMX interface integrated, with 12 x RGBW(3000K) 3535 LED. IP67 rating.

201202
10W

CCT	Beam Angle	lm	lm/w	Finish	Dimming
.RW RGBW	.15 15°	380	38.00	.GL <input type="checkbox"/> Clear Glass	.D DALI
	.30 30°	365	36.50		.X DMX
	.60 60°	335	33.50		
	.E6 10X60° elliptical	365	36.50		

LUMINAIRE

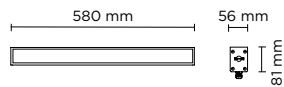

RECESS HOUSING

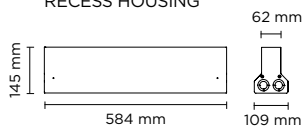

PRODUCT WEIGHT 5,50 kg



Lineaground 600 Trimless HP DMX RGBW

Code Example

201206.RW.15.GL.O

Accessories p. 149

Trimless version of linear shape ground-recessed luminaire for outdoor installation, length 590mm, made in phospho-chromatised and polyester powder coated extruded copper-free aluminium, with tempered safety glass, moulded silicone gaskets, extruded aluminum back box. Light source tilt system +/- 15deg from outside. Built-in LED driver 220-240V 50-60Hz, DMX interface integrated, with 24 x RGBW(3000K) 3535 LED. IP67 rating.

201206
20W

CCT	Beam Angle	lm	lm/w	Finish	Dimming
.RW RGBW	.15 15°	760	38.00	.GL <input type="checkbox"/> Clear Glass	.D DALI
	.30 30°	730	36.50		.X DMX
	.60 60°	670	33.50		
	.E6 10X60° elliptical	730	36.50		

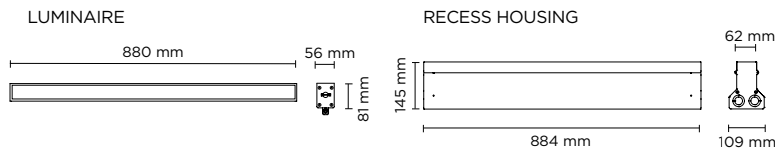

PRODUCT WEIGHT 7,00 kg



Lineaground 900 Trimless HP DMX RGBW

Code Example

201210.RW.15.GL.D

Accessories p. 149

Trimless version of linear shape ground-recessed luminaire for outdoor installation, length 890mm, made in phospho-chromatised and polyester powder coated extruded copper-free aluminium, with tempered safety glass, moulded silicone gaskets, extruded aluminum back box. Light source tilt system +/- 15deg from outside. Built-in LED driver 220-240V 50-60Hz, DMX interface integrated, with 36 x RGBW(3000K) 3535 LED. IP67 rating.

CCT	Beam Angle	lm	lm/w	Finish	Dimming
201210 30W	.15 15°	1.140	38.00	.GL <input type="checkbox"/> Clear Glass	.D DALI
	.30 30°	1.095	36.50		.X DMX
	.60 60°	1.005	33.50		
	.E6 10X60° elliptical	1.095	36.50		

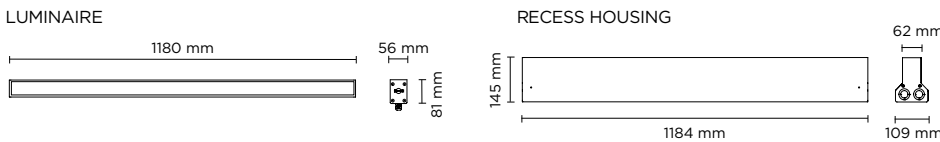

PRODUCT WEIGHT 9,50 kg



Lineaground 1200 Trimless HP DMX RGBW

Code Example

201214.RW.15.GL.D

Accessories p. 149

Trimless version of linear shape ground-recessed luminaire for outdoor installation, length 1190mm, made in phospho-chromatised and polyester powder coated extruded copper-free aluminium, with tempered safety glass, moulded silicone gaskets, extruded aluminum back box. Light source tilt system +/- 15deg from outside. Built-in LED driver 220-240V 50-60Hz, DMX interface integrated, with 48 x RGBW(3000K) 3535 LED. IP67 rating.

CCT	Beam Angle	lm	lm/w	Finish	Dimming
201214 40W	.15 15°	1.520	38.00	.GL <input type="checkbox"/> Clear Glass	.D DALI
	.30 30°	1.460	36.50		.X DMX
	.60 60°	1.340	33.50		
	.E6 10X60° elliptical	1.460	36.50		

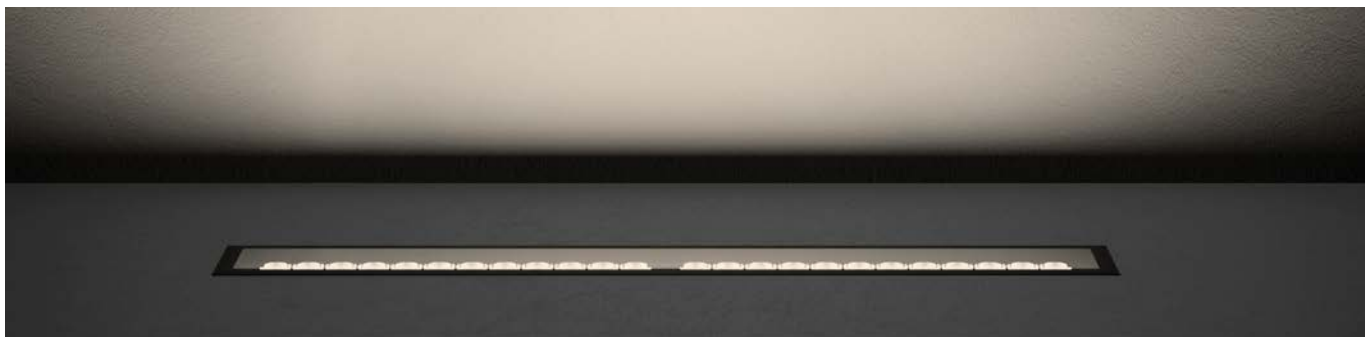

Lineaground Trimless Tunable-White

LUMINAIRE

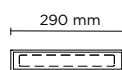

RECESS HOUSING

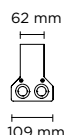
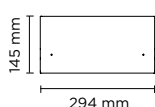

PRODUCT WEIGHT 3,00 kg



Code Example

201203 .TW .15 .GL .D

Accessories p. 149

Lineaground 300 Trimless HP DMX Tunable-White

Trimless version of linear shape ground-recessed luminaire for outdoor installation, length 294mm, made in phospho-chromatised and polyester powder coated extruded copper-free aluminium, with tempered safety glass, moulded silicone gaskets, extruded aluminum back box. Light source tilt system +/- 15deg from outside. Remote 24V DC power supply needed, DMX interface integrated, with 12 x Tunable White 3535 LED (2700K-5590K). IP67 rating.

201203
10W

CCT	Beam Angle	lm	lm/w	Finish	Dimming
.TW 2700°K 5600°K	.15 15°	650	65.00	.GL <input type="checkbox"/> Clear Glass	.D DALI .X DMX
	.30 30°	635	63.50		
	.60 60°	620	62.00		
	.E6 10X60° elliptical	635	63.50		

LUMINAIRE

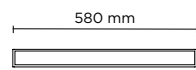

RECESS HOUSING

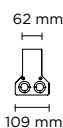
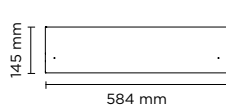

PRODUCT WEIGHT 5,50 kg



Code Example

201207 .TW .15 .GL .D

Accessories p. 149

Lineaground 600 Trimless HP DMX Tunable-White

Trimless version of linear shape ground-recessed luminaire for outdoor installation, length 590mm, made in phospho-chromatised and polyester powder coated extruded copper-free aluminium, with tempered safety glass, moulded silicone gaskets, extruded aluminum back box. Light source tilt system +/- 15deg from outside. Built-in LED driver 220-240V 50-60Hz, DMX interface integrated, with 24 x Tunable White 3535 LED (2700K-5590K). IP67 rating.

201207
20W

CCT	Beam Angle	lm	lm/w	Finish	Dimming
.TW 2700°K 5600°K	.15 15°	1.300	65.00	.GL <input type="checkbox"/> Clear Glass	.D DALI .X DMX
	.30 30°	1.270	63.50		
	.60 60°	1.240	62.00		
	.E6 10X60° elliptical	1.270	63.50		

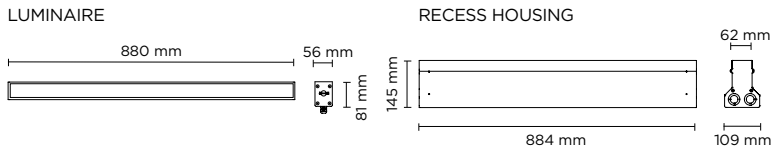

PRODUCT WEIGHT 7,00 kg



Lineaground 900 Trimless HP DMX Tunable-White

Code Example

201211.TW.15.GL.D

Accessories p. 149

Trimless version of linear shape ground-recessed luminaire for outdoor installation, length 890mm, made in phospho-chromatised and polyester powder coated extruded copper-free aluminium, with tempered safety glass, moulded silicone gaskets, extruded aluminum back box. Light source tilt system +/- 15deg from outside. Built-in LED driver 220-240V 50-60Hz, DMX interface integrated, with 36 x Tunable White 3535 LED (2700K-5590K). IP67 rating.

CCT	Beam Angle	lm	lm/w	Finish	Dimming	
201211 30W	.TW 2700°K 5600°K	.15 15°	1.950	65.00	.GL <input type="checkbox"/> Clear Glass	.D DALI
		.30 30°	1.905	63.50		.X DMX
		.60 60°	1.860	62.00		
		.E6 10X60° elliptical	1.905	63.50		

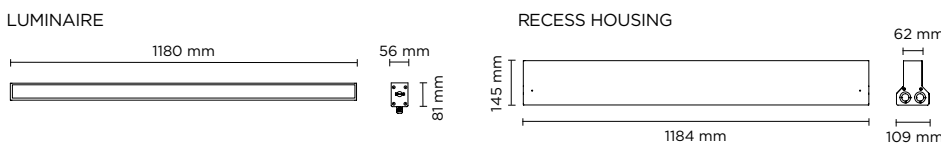

PRODUCT WEIGHT 9,50 kg



Lineaground 1200 Trimless HP DMX Tunable-White

Code Example

201215.TW.15.GL.D

Accessories p. 149

Trimless version of linear shape ground-recessed luminaire for outdoor installation, length 1190mm, made in phospho-chromatised and polyester powder coated extruded copper-free aluminium, with tempered safety glass, moulded silicone gaskets, extruded aluminum back box. Light source tilt system +/- 15deg from outside. Built-in LED driver 220-240V 50-60Hz, DMX interface integrated, with 48 x Tunable White 3535 LED (2700K-5590K). IP67 rating.

CCT	Beam Angle	lm	lm/w	Finish	Dimming	
201215 40W	.TW 2700°K 5600°K	.15 15°	2.600	65.00	.GL <input type="checkbox"/> Clear Glass	.D DALI
		.30 30°	2.540	63.50		.X DMX
		.60 60°	2.480	62.00		
		.E6 10X60° elliptical	2.540	63.50		

Lineaground Trimless Diffused

LUMINAIRE

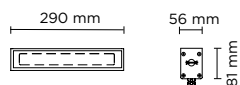

RECESS HOUSING

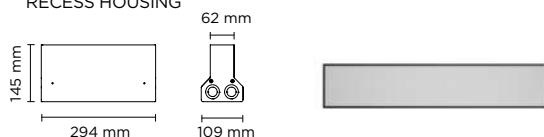

PRODUCT WEIGHT 3,00 kg



Code Example

201204.27.DF.GL.0

Accessories p. 149

Lineaground 300 Trimless Diffused

Trimless version of linear shape ground-recessed luminaire for outdoor installation, length 294mm, made in phospho-chromatised and polyester powder coated extruded copper-free aluminium, with tempered safety glass, moulded silicone gaskets, extruded aluminum back box. Light source tilt system +/- 15deg from outside. Built-in LED driver 220-240V 50-60Hz, with 12 x SAMSUNG 3030 LED. IP67 rating.

201204

8W

CCT	Beam Angle	lm	lm/w
.27 2700°K	.DF Diffused	300	37.50
.30 3000°K	.DF Diffused	310	38.75
.40 4000°K	.DF Diffused	330	41.25

Finish

.GL Clear Glass

Dimming

.0 ON/OFF

.D DALI

LUMINAIRE

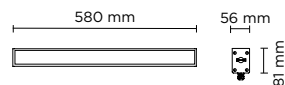

RECESS HOUSING



PRODUCT WEIGHT 5,50 kg

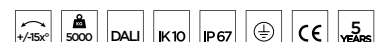

Code Example

201208.27.DF.GL.0

Accessories p. 149

Lineaground 600 Trimless Diffused

Trimless version of linear shape ground-recessed luminaire for outdoor installation, length 590mm, made in phospho-chromatised and polyester powder coated extruded copper-free aluminium, with tempered safety glass, moulded silicone gaskets, extruded aluminum back box. Light source tilt system +/- 15deg from outside. Built-in LED driver 220-240V 50-60Hz, with 24 x SAMSUNG 3030 LED. IP67 rating.

201208

12W

CCT	Beam Angle	lm	lm/w
.27 2700°K	.DF Diffused	500	41.66
.30 3000°K	.DF Diffused	520	43.33
.40 4000°K	.DF Diffused	550	45.83

Finish

.GL Clear Glass

Dimming

.0 ON/OFF

.D DALI

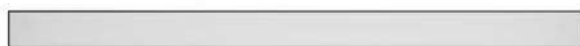
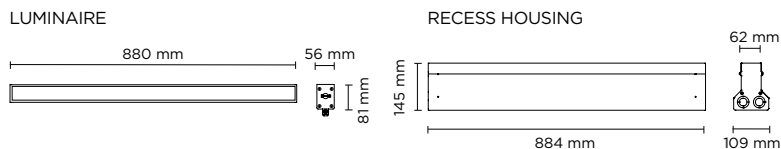

PRODUCT WEIGHT 7,00 kg

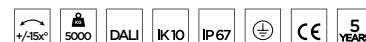

Lineaground 900 Trimless Diffused

Code Example

201212, .27, .DF, .GL, .O

Accessories p. 149

Trimless version of linear shape ground-recessed luminaire for outdoor installation, length 890mm, made in phospho-chromatised and polyester powder coated extruded copper-free aluminium, with tempered safety glass, moulded silicone gaskets, extruded aluminum back box. Light source tilt system +/- 15deg from outside. Built-in LED driver 220-240V 50-60Hz, with 36 x SAMSUNG 3030 LED. IP67 rating.

	CCT	Beam Angle	lm	lm/w	Finish	Dimming
201212	.27 2700°K	.DF Diffused	780	45.88	.GL <input type="checkbox"/> Clear Glass	.O ON/OFF
17W	.30 3000°K	.DF Diffused	800	47.06		.D DALI
	.40 4000°K	.DF Diffused	830	48.80		

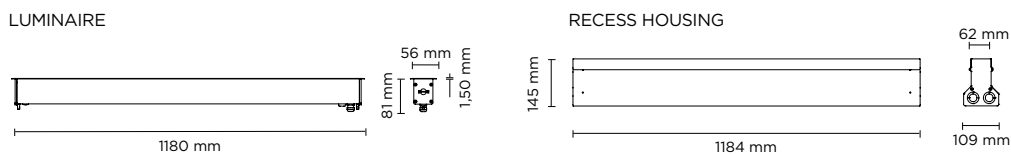

PRODUCT WEIGHT 9,50 kg

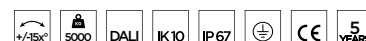

Lineaground 1200 Trimless Diffused

Code Example

201216, .27, .DF, .GL, .O

Accessories p. 149

Trimless version of linear shape ground-recessed luminaire for outdoor installation, length 1190mm, made in phospho-chromatised and polyester powder coated extruded copper-free aluminium, with tempered safety glass, moulded silicone gaskets, extruded aluminum back box. Light source tilt system +/- 15deg from outside. Built-in LED driver 220-240V 50-60Hz, with 48 x SAMSUNG 3030 LED. IP67 rating.

	CCT	Beam Angle	lm	lm/w	Finish	Dimming
201216	.27 2700°K	.DF Diffused	1.010	42.08	.GL <input type="checkbox"/> Clear Glass	.O ON/OFF
24W	.30 3000°K	.DF Diffused	1.050	43.75		.D DALI
	.40 4000°K	.DF Diffused	1.100	45.83		

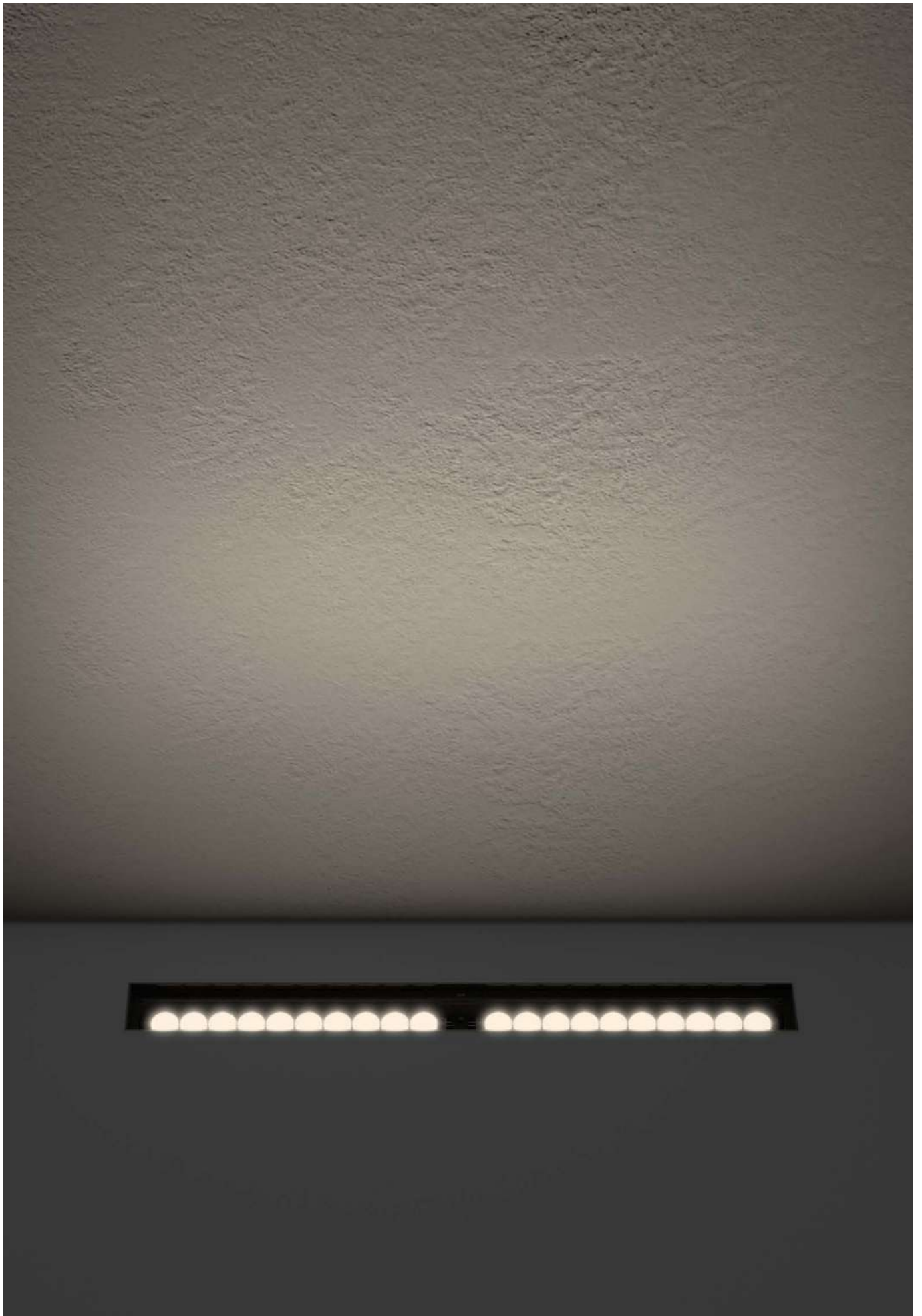

PRODUCT OVERVIEW



NO EXPOSED SCREWS ONCE THE PRODUCT IS INSTALLED



PLENTY OF SOLUTIONS AS ANTI-GLARE ACCESSORIES



CONTINUOUS LINE OF LIGHT (END TO END INSTALLATION)

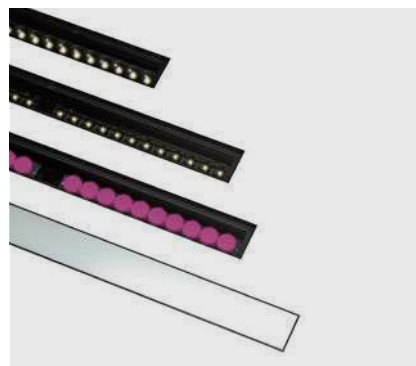

VARIETY OF LIGHT SOURCE & MODELS



SPECIAL TILT SYSTEM INTEGRATED ALLOWING ON SITE ADJUSTMENT +/- 15 DEG WITHOUT OPENING THE LUMINAIRE

LIGHT BEAM OPTIONS

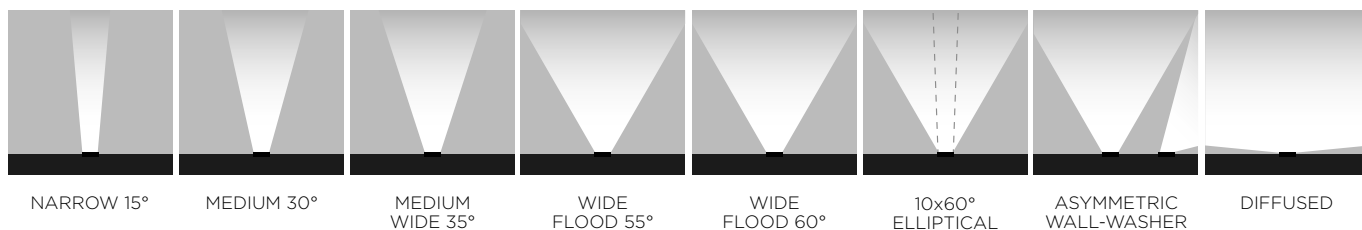

INTEGRATED ACCESSORIES

201201.27.15.GL.0.---

Built-in accessories to be requested when ordering
example 201201.27.15.GL.7.HC



.ML

MICROLOUVRE

Anti-glare grid that sections the light beam into microcells, adding visual comfort without compromising the quality or homogeneity of the light.

Available for:

- LINEAGROUND TRIMLESS HP ITEMS
- LINEAGROUND TRIMLESS HP DMX RGBW ITEMS
- LINEAGROUND TRIM. HP DMX TUN. WHITE ITEMS

ACCESSORIES NOT INCLUDED

Accessories to be ordered separately.



AC133

FEED CABLE 1 MT. ON/OFF

Initial cable 3 core, to start an in-line installation, cable length 1 meter. Open wires for mains connection and IP68 connector for fixture connection. Available for:
Compatible for all products of the series.



AC137

JUMPER CABLE 4 MT. ON/OFF

4 meters length extension, 3 core cable with male and female IP68 connectors (end to end).
Compatible for all products of the series.



AC134

FEED CABLE 1 MT. DALI

Initial cable 5 core, to start an in-line DALI installation, cable length 1 meter. Open wires for mains connection and IP68 connector for fixture connection. Available for:
- LINEAGROUND TRIMLESS HP ITEMS
- LINEAGROUND TRIMLESS DIFFUSED ITEMS



AC138

JUMPER CABLE 4 MT. DALI

4 meters length extension, 5 core DALI cable with male and female IP68 connectors (end to end). Available for:
- LINEAGROUND TRIMLESS HP ITEMS
- LINEAGROUND TRIMLESS DIFFUSED ITEMS



AC135

JUMPER CABLE 2 MT. ON/OFF

2 meters length extension, 3 core cable with male and female IP68 connectors (end to end).
Compatible for all products of the series.



AC139

JUMPER CABLE 2 MT. ON/OFF

End cap for connectors, to terminate the in-line installation of light fixture equipped with 3 core cable.
Compatible for all products of the series.



AC136

JUMPER CABLE 2 MT. DALI

2 meters length extension, 5 core DALI cable with male and female IP68 connectors (end to end). Available for:
- LINEAGROUND TRIMLESS HP ITEMS
- LINEAGROUND TRIMLESS DIFFUSED ITEMS



AC140

END CAP DALI

End cap for connectors, to terminate the in-line installation of light fixture equipped with 5 core cable (DALI). Available for:
- LINEAGROUND TRIMLESS HP ITEMS
- LINEAGROUND TRIMLESS DIFFUSED ITEMS



AC141

KIT "CONTINUOUS LINE" FOR LINEAGROUND TRIMLESS

Alignment rods + securing screws, to allow create "Continuous line" system joining various Lineaground Trimless units together. Available for:
ALL LINEAGROUND TRIMLESS ITEMS

UN
DER
WA
TER





Scuba

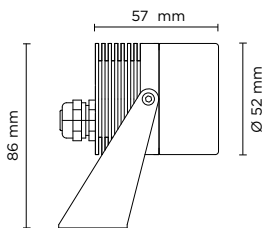

PRODUCT WEIGHT 1,50 kg



Code Example

301001,**.27**,**.10**,**.SS**,**.0**

Accessories p. 155

301001
1,5W

Scuba Micro

Small underwater projector, surface mounted, completely made in stainless steel AISI 316L, silicone o-rings, 350/500mA remote driver needed, with 1 CREE XP-G3 LED. IP 68 rating.

CCT	Beam Angle	lm	lm/w	Finish	Dimming
.27 2700°K	.10 10°	137	91.33	.SS Stainless Steel	.0 ON/OFF
	.30 30°	130	86.67		
	.45 45°	124	82.67		
.30 3000°K	.10 10°	144	96.00	.SS Stainless Steel	.0 ON/OFF
	.30 30°	137	91.34		
	.45 45°	130	86.67		
.40 4000°K	.10 10°	150	100.00	.SS Stainless Steel	.0 ON/OFF
	.30 30°	143	95.34		
	.45 45°	136	90.67		

Remote Driver Selection

Brand	Manufacturer code	Type	Watt	IP Rate	Number of fixtures
TCI Italy	122086	constant current 350 MA	4W	IP20	min 1 - max 2
TCI Italy	122204	constant current 350 MA/500 MA	25W - 35W	IP20	min 1 - max 16
Meanwell	LPC-20-350	constant current 350 MA	16.8W	IP67	min 4 - max 12
Meanwell	LPC-20-700	constant current 700 MA	21W	IP67	min 4 - max 8
Meanwell	LPF-25-48	constant current 530 MA	25W	IP67	min 10 - max 16

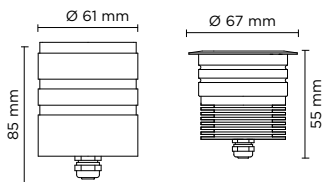

PRODUCT WEIGHT 1,50 kg



Scuba Micro Recess

Small underwater luminaire, wall-recessed, completely made in stainless steel AISI 316L, silicone o-rings, acetal resin housing for recess. 350/500mA remote driver needed, with 1 CREE XP-G3 LED. IP 68 rating.

Code Example

301002.**27**.**10**.**SS**.**0**

Accessories p. 155

301002
1,5W

CCT	Beam Angle	lm	lm/w	Finish	Dimming
.27 2700°K	.10 10°	137	91.33	.SS Stainless Steel	.0 ON/OFF
	.30 30°	130	86.67		
	.45 45°	124	82.67		
.30 3000°K	.10 10°	144	96.00	.SS Stainless Steel	.0 ON/OFF
	.30 30°	137	91.34		
	.45 45°	130	86.67		
.40 4000°K	.10 10°	150	100.00	.SS Stainless Steel	.0 ON/OFF
	.30 30°	143	95.34		
	.45 45°	136	90.67		

Remote Driver Selection

Brand	Manufacturer code	Type	Watt	IP Rate	Number of fixtures
TCI Italy	122086	constant current 350 MA	4W	IP20	min 1 - max 2
TCI Italy	122204	constant current 350 MA/500 MA	25W - 35W	IP20	min 1 - max 16
Meanwell	LPC-20-350	constant current 350 MA	16.8W	IP67	min 4 - max 12
Meanwell	LPC-20-700	constant current 700 MA	21W	IP67	min 4 - max 8
Meanwell	LPF-25-48	constant current 530 MA	25W	IP67	min 10 - max 16

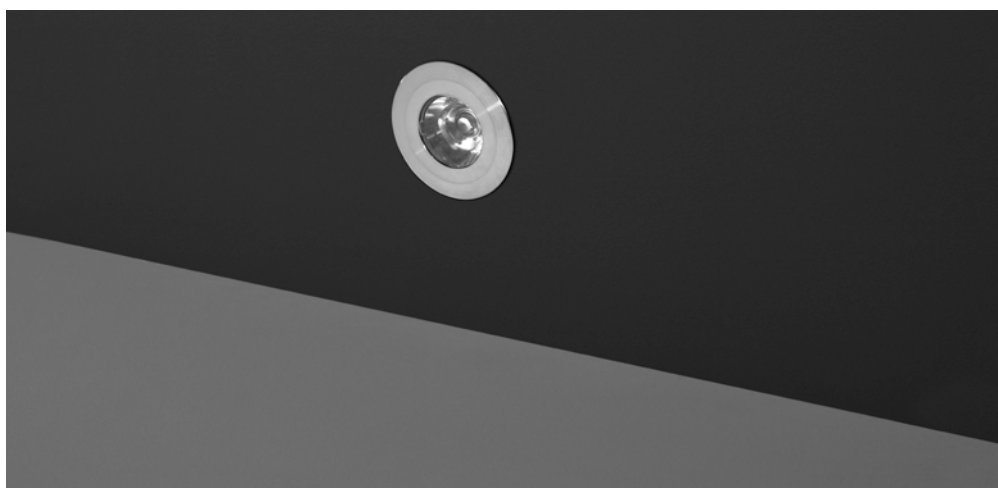

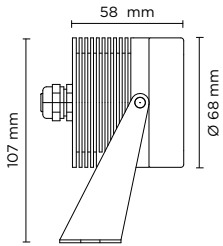

PRODUCT WEIGHT 2,00 kg



Code Example

301003.**.27**.**.10**.**SS**.**.0**

Accessories p. 155

Scuba Mini

Small underwater projector, surface mounted, completely made in stainless steel AISI 316L, silicone o-rings, 350/500mA remote driver needed, with 4 CREE XP-G3 LED. IP 68 rating.

301003
6W

CCT	Beam Angle	lm	lm/w	Finish	Dimming
.27 2700°K	.10 10°	547	91.17	.SS Stainless Steel	.0 ON/OFF
	.30 30°	521	86.83		
.30 3000°K	.10 10°	576	96.00		
	.30 30°	548	91.34		
.40 4000°K	.10 10°	600	100.00		
	.30 30°	570	95.00		

Remote Driver Selection

Brand	Manufacturer code	Type	Watt	IP Rate	Number of fixtures
TCI Italy	127711	constant current 500 MA	12W	IP20	1
TCI Italy	122204	constant current 350 MA/500 MA	25W - 35W	IP20	min 1 - max 4
Meanwell	LPC-20-350	constant current 350 MA	16.8W	IP67	min 1 - max 2
Meanwell	LPC-20-700	constant current 700 MA	21W	IP67	min 1 - max 2
Meanwell	LPF-25-48	constant current 530 MA	25W	IP67	min 3 - max 4

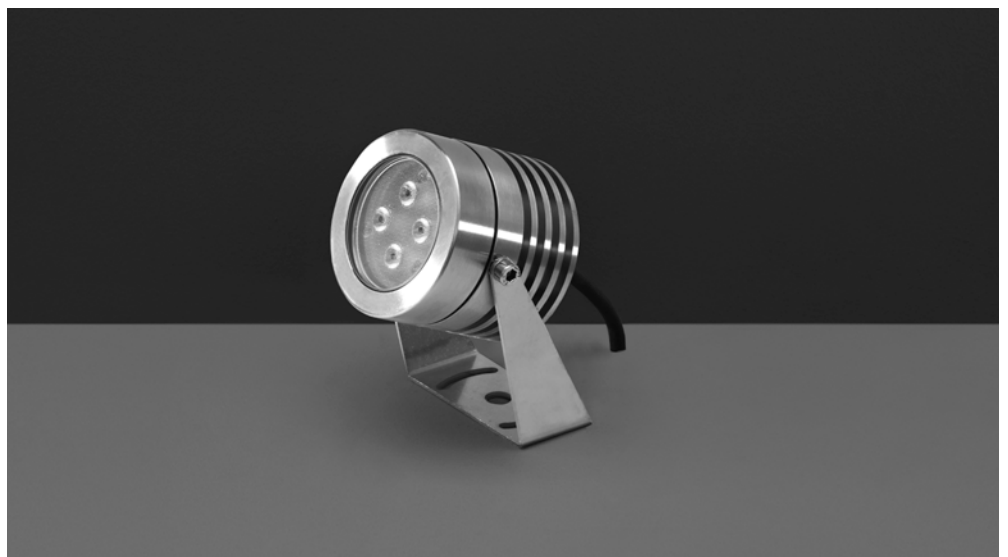

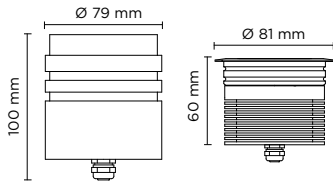

PRODUCT WEIGHT 2,00 kg



Scuba Mini Recess

Small underwater luminaire, wall-recessed, completely made in stainless steel AISI 316L, silicone o-rings, acetal resin housing for recess. 350/500mA remote driver needed, with 4 CREE XP-G3 LED. IP 68 rating.

Code Example

301004, **.27**, **.10**, **SS**, **.0**

Accessories p. 155

301004
6W

CCT	Beam Angle	lm	lm/w	Finish	Dimming
.27 2700°K	.10 10°	547	91.17	.SS Stainless Steel	.0 ON/OFF
	.30 30°	521	86.83		
.30 3000°K	.10 10°	576	96.00	.SS Stainless Steel	.0 ON/OFF
	.30 30°	548	91.34		
.40 4000°K	.10 10°	600	100.00	.SS Stainless Steel	.0 ON/OFF
	.30 30°	570	95.00		

Remote Driver Selection

Brand	Manufacturer code	Type	Watt	IP Rate	Number of fixtures
TCI Italy	127711	constant current 500 MA	12W	IP20	1
TCI Italy	122204	constant current 350 MA/500 MA	25W - 35W	IP20	min 1 - max 4
Meanwell	LPC-20-350	constant current 350 MA	16.8W	IP67	min 1 - max 2
Meanwell	LPC-20-700	constant current 700 MA	21W	IP67	min 1 - max 2
Meanwell	LPF-25-48	constant current 530 MA	25W	IP67	min 3 - max 4

ACCESSORIES NOT INCLUDED

Accessories to be ordered separately.



AC024

SPIKE

Ground-mounted installation accessory.

Available for:

- SCUBA MICRO
- SCUBA MINI



Pool

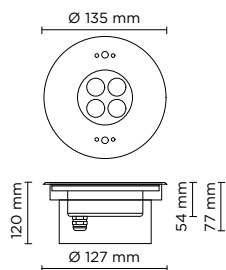

PRODUCT WEIGHT 1,30 kg



Code Example

303004, .30, .30, SS, .0

Pool Mini

Swimming-pool underwater luminaire, round shape, wall-recessed, completely made in stainless steel AISI 316L, polypropylene housing for recess. 24V remote driver needed, with 4 OSRAM LED. IP 68 rating.

303004
8W

CCT	Beam Angle	lm	lm/w	Finish	Dimming
.30 3000°K	.30 30°	415	51.87	.SS Stainless Steel	.0 ON/OFF

Remote Driver Selection

Brand	Manufacturer code	Type	Watt	IP Rate	Number of fixtures
Meanwell	LPV-20-24	constant voltage 24V DC	20W	IP67	min 1 - max 2
Meanwell	LPV-35-24	constant voltage 24V DC	35W	IP67	min 1 - max 3
Meanwell	LPV-60-24	constant voltage 24V DC	60W	IP67	min 1 - max 6
Meanwell	LPV-100-24	constant voltage 24V DC	100W	IP67	min 1 - max 11

THIS LUMINAIRE IS SUITABLE ONLY FOR UNDERWATER INSTALLATION

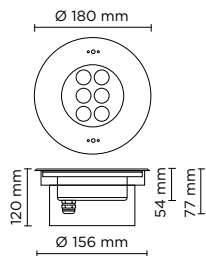

PRODUCT WEIGHT 2,00 kg



Code Example

303001, 30, 30, SS, 0

Pool Medium

Swimming-pool underwater luminaire, round shape, wall-recessed, completely made in stainless steel AISI 316L, polypropylene housing for recess. 24V remote driver needed, with 6 OSRAM LED. IP 68 rating.

CCT	Beam Angle	lm	lm/w	Finish	Dimming
.30 3000°K	.30 30°	1.200	100.00	.SS Stainless Steel	.0 ON/OFF

303001

12W

Remote Driver Selection

Brand	Manufacturer code	Type	Watt	IP Rate	Number of fixtures
Meanwell	LPV-20-24	constant voltage 24V DC	20W	IP67	1
Meanwell	LPV-35-24	constant voltage 24V DC	35W	IP67	min 1 - max 2
Meanwell	LPV-60-24	constant voltage 24V DC	60W	IP67	min 1 - max 4
Meanwell	LPV-100-24	constant voltage 24V DC	100W	IP67	min 1 - max 7

THIS LUMINAIRE IS SUITABLE ONLY FOR UNDERWATER INSTALLATION

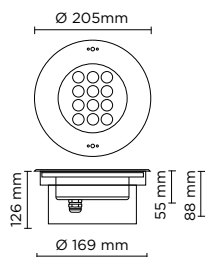

PRODUCT WEIGHT 3,80 kg



Code Example

303002, 30, 30, SS, 0

Pool Maxi

Swimming-pool underwater luminaire, round shape, wall-recessed, completely made in stainless steel AISI 316L, polypropylene housing for recess. 24V remote driver needed, with 12 OSRAM LED. IP 68 rating.

CCT	Beam Angle	lm	lm/w	Finish	Dimming
.30 3000°K	.30 30°	2.000	83.34	.SS Stainless Steel	.0 ON/OFF

303002

24W

Remote Driver Selection

Brand	Manufacturer code	Type	Watt	IP Rate	Number of fixtures
Meanwell	LPV-35-24	constant voltage 24V DC	35W	IP67	1
Meanwell	LPV-60-24	constant voltage 24V DC	60W	IP67	min 1 - max 2
Meanwell	LPV-100-24	constant voltage 24V DC	100W	IP67	min 1 - max 3

THIS LUMINAIRE IS SUITABLE ONLY FOR UNDERWATER INSTALLATION

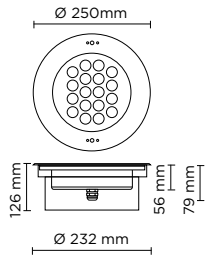

PRODUCT WEIGHT 3,80 kg

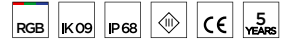

Code Example

303003 . 30 . 30 . SS . 0

Pool Mega

Swimming-pool underwater luminaire, round shape, wall-recessed, completely made in stainless steel AISI 316L, polypropylene housing for recess. 24V remote driver needed, with 18 OSRAM LED. IP 68 rating.

303003
36W

CCT	Beam Angle	lm	lm/w	Finish	Dimming
.30 3000°K	.30 30°	2.900	80.56	.SS Stainless Steel	.0 ON/OFF

Remote Driver Selection

Brand	Manufacturer code	Type	Watt	IP Rate	Number of fixtures
Meanwell	LPV-60-24	constant voltage 24V DC	60W	IP67	1
Meanwell	LPV-100-24	constant voltage 24V DC	100W	IP67	min 1 - max 2

⚠ THIS LUMINAIRE IS SUITABLE ONLY FOR UNDERWATER INSTALLATION



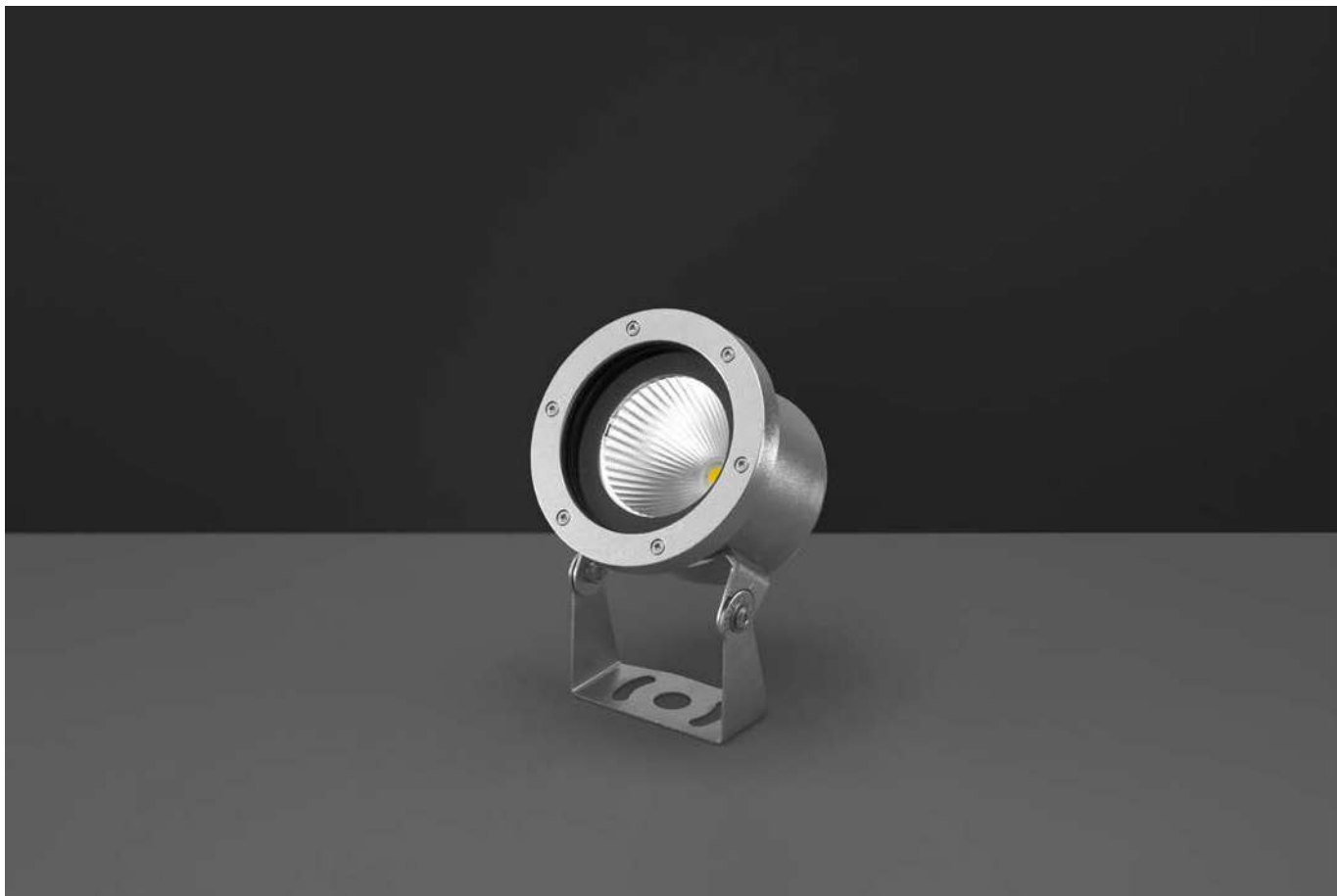

Dive

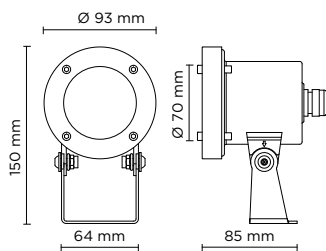

PRODUCT WEIGHT 1,10 kg

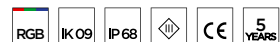

Dive Mini

Underwater projector, surface mounted, completely made in stainless steel AISI 316L, silicone gasket, 24V DC remote driver needed, with 1 x COB LED. IP 68 rating.

Code Example

305001 .30 .30 .SS .0

305001
8W

CCT	Beam Angle	lm	lm/w	Finish	Dimming
.30 3000°K	.30 30°	607	75.87	.SS Stainless Steel	.0 ON/OFF

Remote Driver Selection

Brand	Manufacturer code	Type	Watt	IP Rate	Number of fixtures
Meanwell	LPV-20-24	constant voltage 24V DC	20W	IP67	min 1 - max 2
Meanwell	LPV-35-24	constant voltage 24V DC	35W	IP67	min 1 - max 3
Meanwell	LPV-60-24	constant voltage 24V DC	60W	IP67	min 1 - max 6

THIS LUMINAIRE IS SUITABLE ONLY FOR UNDERWATER INSTALLATION

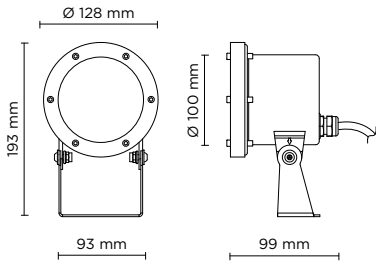

PRODUCT WEIGHT 1,60 kg



Dive Medium

Underwater projector, surface mounted, completely made in stainless steel AISI 316L, silicone gasket, 24V DC remote driver needed, with 1 x COB LED. IP 68 rating.

Code Example

305002.30.30.SS.0

305002

16W

CCT	Beam Angle	lm	lm/w	Finish	Dimming
.30 3000°K	.30 30°	1.183	73.94	.SS Stainless Steel	.0 ON/OFF

Remote Driver Selection

Brand	Manufacturer code	Type	Watt	IP Rate	Number of fixtures
Meanwell	LPV-20-24	constant voltage 24V DC	20W	IP67	1
Meanwell	LPV-60-24	constant voltage 24V DC	60W	IP67	min 1 - max 3

THIS LUMINAIRE IS SUITABLE ONLY FOR UNDERWATER INSTALLATION

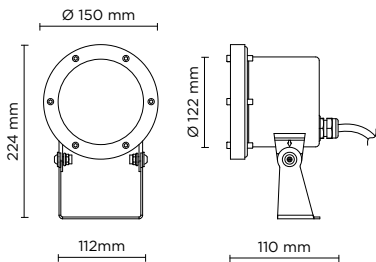

PRODUCT WEIGHT 2,00 kg



Dive Maxi

Underwater projector, surface mounted, completely made in stainless steel AISI 316L, silicone gasket, 24V DC remote driver needed, with 1 x COB LED. IP 68 rating.

Code Example

305003.30.30.SS.0

305003

20W

CCT	Beam Angle	lm	lm/w	Finish	Dimming
.30 3000°K	.30 30°	1.478	73.90	.SS Stainless Steel	.0 ON/OFF

Remote Driver Selection

Brand	Manufacturer code	Type	Watt	IP Rate	Number of fixtures
Meanwell	LPV-35-24	constant voltage 24V DC	35W	IP67	1
Meanwell	LPV-60-24	constant voltage 24V DC	60W	IP67	min 1 - max 2
Meanwell	LPV-100-24	constant voltage 24V DC	120W	IP67	min 1 - max 4

THIS LUMINAIRE IS SUITABLE ONLY FOR UNDERWATER INSTALLATION



Hydroflex Underwater

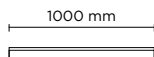

Hydroflex Side 1000 Underwater

Code Example

306001.30.DF.OP.O

Accessories p. 165

1.000 mm length, 20mm x 12mm section, opal encapsulated flexible LED strip for linear lighting (straight or bended) outdoor and indoor wall-recessed installation; surface mounted version through installation accessories to be ordered separately. LED circuit completely encapsulated with UV and high-temperatures resistant Polyurethane sheath, with white (outside) and milky finish (over light emission), dot free and homogeneous light emission surface. Double power cable with male/female connectors included, suitable for in-line installation. Remote driver 24V DC needed. With nr. 140 low-power SMD3014 Lumileds LED. IP68 rating.

306001
10W

CCT	Beam Angle	lm	lm/w	Finish	Dimming
.30 3000°K	.DF diffused	750	75.00	.OP <input type="checkbox"/> Milky	.0 ON/OFF

Remote Driver Selection

Brand	Manufacturer code	Type	Watt	IP Rate	Number of fixtures
Meanwell	LPV-20-24	constant voltage 24V DC	20W	IP67	1
Meanwell	LPV-35-24	constant voltage 24V DC	35W	IP67	min 1 - max 2
Meanwell	LPV-60-24	constant voltage 24V DC	60W	IP67	min 1 - max 5
Meanwell	LPV-100-24	constant voltage 24V DC	100W	IP67	min 1 - max 9

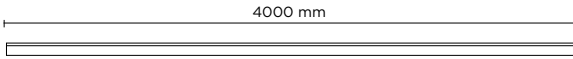

Hydroflex Side 4000 Underwater



Code Example

306002.**30**.**DF**.**OP**.**0**

Accessories p. 165

4.000 mm length, 20mm x 12mm section, opal encapsulated flexible LED strip for linear lighting (straight or bended) outdoor and indoor wall-recessed installation; surface mounted version through installation accessories to be ordered separately. LED circuit completely encapsulated with UV and high-temperatures resistant Polyurethane sheath, with white (outside) and milky finish (over light emission), dot free and homogeneous light emission surface. Double power cable with male/female connectors included, suitable for in-line installation. Remote driver 24V DC needed. With nr. 140 low-power SMD3014 Lumileds LED. IP68 rating.

306002

40W

CCT	Beam Angle	lm	lm/w	Finish	Dimming
.30 3000°K	.DF diffused	3.000	75.00	.OP <input type="checkbox"/> Milky	.0 ON/OFF

Remote Driver Selection

Brand	Manufacturer code	Type	Watt	IP Rate	Number of fixtures
Meanwell	LPV-60-24	constant voltage 24V DC	60W	IP67	1
Meanwell	LPV-100-24	constant voltage 24V DC	100W	IP67	min 1 - max 2

HYDROFLEX SIDE - SIDE SECTION

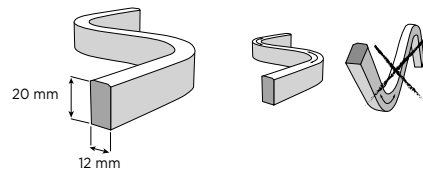
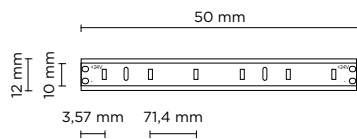
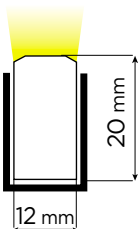

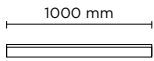

Hydroflex Top 1000 Underwater



Code Example

306003.30.DF.OP.O

Accessories p. 165

1.000 mm length, 16mm x 16mm section, opal encapsulated flexible LED strip for linear lighting (straight or bended), underwater installation version; surface mounted version through installation accessories to be ordered separately. LED circuit completely encapsulated with UV and high-temperatures resistant Polyurethane sheath, with white (outside) and milky finish (over light emission), dot free and homogeneous light emission surface. Double power cable with male/female connectors included, suitable for in-line installation. Remote driver 24V DC needed. With nr. 140 low-power SMD3014 Lumileds LED. IP68 rating.

306003
10W

CCT	Beam Angle	lm	lm/w	Finish	Dimming
.30 3000°K	.DF diffused	750	75.00	.OP <input type="checkbox"/> Milky	.O ON/OFF

Remote Driver Selection

Brand	Manufacturer code	Type	Watt	IP Rate	Number of fixtures
Meanwell	LPV-20-24	constant voltage 24V DC	20W	IP67	1
Meanwell	LPV-35-24	constant voltage 24V DC	35W	IP67	min 1 - max 2
Meanwell	LPV-60-24	constant voltage 24V DC	60W	IP67	min 1 - max 5
Meanwell	LPV-100-24	constant voltage 24V DC	100W	IP67	min 1 - max 9

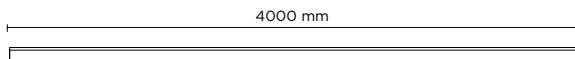

Hydroflex Top 4000 Underwater



Code Example

306004.30.DF.OP.O

Accessories p. 165

4000 mm length, 16mm x 16mm section, opal encapsulated flexible LED strip for linear lighting (straight or bended), underwater installation version; surface mounted version through installation accessories to be ordered separately. LED circuit completely encapsulated with UV and high-temperatures resistant Polyurethane sheath, with white (outside) and milky finish (over light emission), dot free and homogeneous light emission surface. Double power cable with male/female connectors included, suitable for in-line installation. Remote driver 24V DC needed. With nr. 140 low-power SMD3014 Lumileds LED. IP68 rating.

306004
40W

CCT	Beam Angle	lm	lm/w	Finish	Dimming
.30 3000°K	.DF diffused	3.000	75.00	.OP <input type="checkbox"/> Milky	.O ON/OFF

Remote Driver Selection

Brand	Manufacturer code	Type	Watt	IP Rate	Number of fixtures
Meanwell	LPV-60-24	constant voltage 24V DC	60W	IP67	1
Meanwell	LPV-100-24	constant voltage 24V DC	100W	IP67	min 1 - max 2

HYDROFLEX TOP - SIDE SECTION

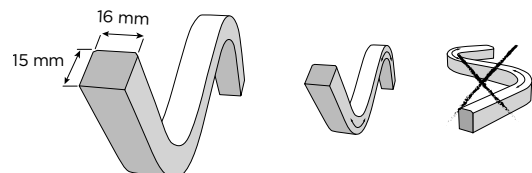
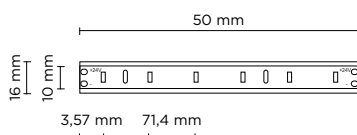
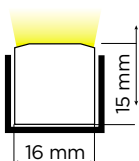

ACCESSORIES NOT INCLUDED

Accessories to be ordered separately.



AC031 **MOUNTING CLIP**

Mounting clip for Hydroflex Side realized in Stainless steel, clip to be applied every 40 cm, to secure with screws. Ideal for bended installation on a wall or ceiling.

Available for:
HYDROFLEX SIDE UNDERWATER



AC032 **ALUMINUM LINEAR PROFILE**

1.000 mm Linear profile for Hydroflex Side, realized in Anodized aluminum.

Available for:
HYDROFLEX SIDE UNDERWATER



AC034 **MOUNTING CLIP**

Mounting clip for Hydroflex Side realized in Stainless steel, clip to be applied every 40 cm, to secure with screws. Ideal for bended installation on a wall or ceiling.

Available for:
HYDROFLEX TOP UNDERWATER



AC035 **ALUMINUM LINEAR PROFILE**

1.000 mm Linear profile for Hydroflex Side, realized in Anodized aluminum.

Available for:
HYDROFLEX TOP UNDERWATER

WALL MOUN TING





Wave

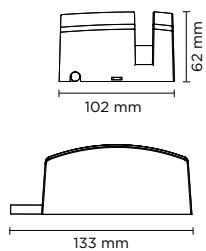

PRODUCT WEIGHT 1,00 kg

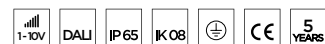

Code Example

401102 .27 .BL .01 .0

Accessories p. 169

Wave 2.0

Surface mounted luminaire for outdoor installation on window sill, with asymmetric 8°x170° "window-washer" light distribution. Phospho-chromatised and polyester powder coated die-cast copper-free aluminium body, tempered safety glass, moulded silicone gasket and stainless steel screws. Built-in LED driver 220-240V 50-60Hz, with 1 x CREE XHP35 LED. IP65 rating.

401102
7W

CCT	Beam Angle	lm	lm/w
.27 2700°K	.BL 8°x170°	553	79.00
.30 3000°K	.BL 8°x170°	582	83.14
.40 4000°K	.BL 8°x170°	600	85.71

Finish	Dimming
.01 RAL 9006	.0 ON/OFF
.02 RAL 7016	.1 1-10V
.03 Matt Black	.D DALI

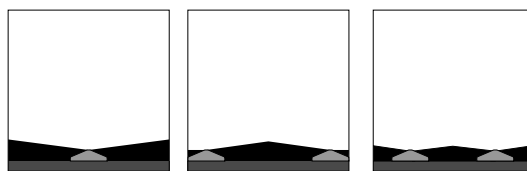

SINGLE INSTALLATION, IN THE MIDDLE. SUGGESTED FOR SMALL / MEDIUM SIZE WINDOWS

DOUBLE INSTALLATION, ON BOTH SIDES. SUGGESTED IN CASE OF HIGH LIGHTING PERFORMANCE NEEDED

DOUBLE INSTALLATION, IN THE MIDDLE. SUGGESTED FOR BIG SIZE WINDOWS

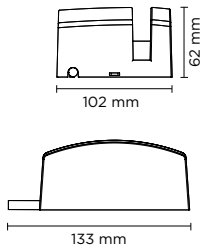

PRODUCT WEIGHT 1,00 kg



Code Example

401102 .RW .BL .01 .X

Accessories p. 169

Wave 2.0 DMX RGBW

Surface mounted luminaire for outdoor installation on window sill, with asymmetric 8°x170° “window-washer” light distribution. Phospho-chromatised and polyester powder coated die-cast copper-free aluminium body, polycarbonate diffuser, moulded silicone gasket and stainless steel screws. Remote 24V DC power supply needed, DMX driver integrated; with 1 x CREE “XML” RGBW LED. IP65 rating.

401102

4,5W

CCT	Beam Angle	lm	lm/w	Finish	Dimming
.RW RGBW	.BL 8°x170°	160	35.55	.01 RAL 9006	X. DMX
				.02 RAL 7016	
				.03 Matt Black	

Remote Driver Selection

Brand	Manufacturer code	Type	Watt	IP Rate	Number of fixtures
Meanwell	LPV-20-24	constant voltage 24V DC	20W	IP67	min 1 - max 3
Meanwell	LPV-35-24	constant voltage 24V DC	35W	IP67	min 1 - max 6



ACCESSORIES

CONTROLLERS, SPLITTERS, ETC...

To be defined together with puk technical department, according to project specifications and after providing installation details.

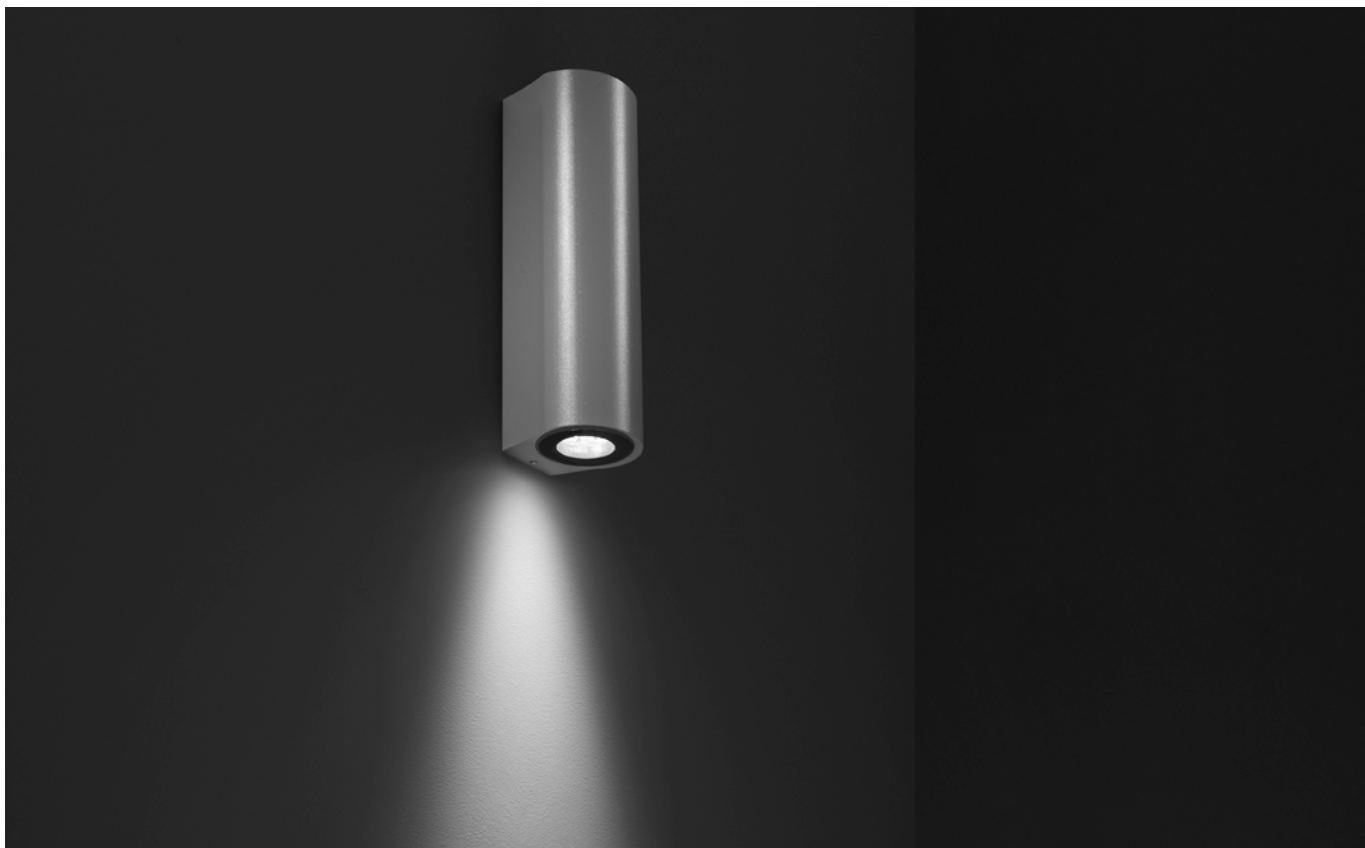

Tech Evo

Momo Design

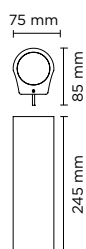

PRODUCT WEIGHT 2,00 kg

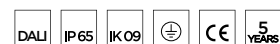

Code Example

402601.30.10.01.0

Tech Evo Mini 01

Wall applique, to be mounted on an outdoor façade/wall, with one side light distribution. Phospho-chromatised and polyester powder coated copper-free extruded aluminium body, tempered safety glass, moulded silicone gasket and stainless steel screws. Built-in LED driver 220-240V 50-60Hz, with 3 CREE XP-G2 LED. IP 65 rating.

402601

5,5 W

CCT	Beam Angle	lm	lm/w	Finish	Dimming
.30 3000°K	.10 10°	550	100.00	.01 RAL 9006	.0 ON/OFF
	.30 30°	520	94.54	.02 RAL 7016	.D DALI
	.45 45°	495	90.00	.03 Matt Black	
.40 4000°K	.10 10°	600	109.09		
	.30 30°	570	103.63		
	.45 45°	540	98.18		

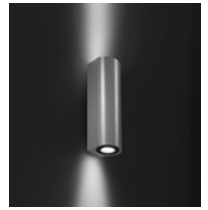
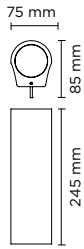

PRODUCT WEIGHT 2,00 kg



Code Example

402602.30.10.01.0

Tech Evo Mini O2

Up & down wall applique for outdoor installation. Phospho-chromatised and polyester powder coated copper-free extruded aluminium body, tempered safety glass, moulded silicone gasket and stainless steel screws. Built-in LED driver 220-240V 50-60Hz, with 2 x 3 CREE XP-G2 LED. IP 65 rating.

402602

11 W

CCT	Beam Angle	lm	lm/w	Finish	Dimming
.30 3000°K	.10 10°	2 x 550	100.00	.01 RAL 9006	.0 ON/OFF
	.30 30°	2 x 520	94.54	.02 RAL 7016	.D DALI
	.45 45°	2 x 495	90.00	.03 Matt Black	
.40 4000°K	.10 10°	2 x 600	109.09		
	.30 30°	2 x 570	103.63		
	.45 45°	2 x 540	98.18		

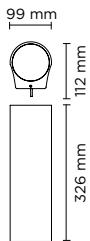

PRODUCT WEIGHT 3,50 kg



Code Example

402603.27.14.01.0

Tech Evo Medium O1

Wall applique, to be mounted on an outdoor façade/wall, with one side light distribution. Phospho-chromatised and polyester powder coated copper-free extruded aluminium body, tempered safety glass, moulded silicone gasket and stainless steel screws. Built-in LED driver 220-240V 50-60Hz, with 1 COB CREE "CXB 1512" LED. IP 65 rating.

402603

15 W

CCT	Beam Angle	lm	lm/w	Finish	Dimming
.27 2700°K	.14 14°	1.853	123.53	.01 RAL 9006	.0 ON/OFF
	.35 35°	1.758	117.20	.02 RAL 7016	.1 1-10V
	.55 55°	1.710	114.00	.03 Matt Black	.D DALI
.30 3000°K	.14 14°	1.951	130.06		
	.35 35°	1.850	123.33		
	.55 55°	1.800	120.00		
.40 4000°K	.14 14°	2.240	149.33		
	.35 35°	2.131	142.06		
	.55 55°	2.046	136.40		

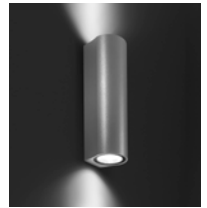
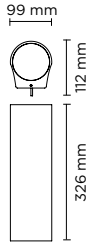

PRODUCT WEIGHT 3,50 kg



Tech Evo Medium O2

Code Example

402604.27.14.01.0

Up & down wall applique for outdoor installation. Phospho-chromatised and polyester powder coated copper-free extruded aluminium body, tempered safety glass, moulded silicone gasket and stainless steel screws. Built-in LED driver 220-240V 50-60Hz, with 2 x 1 COB CREE "CXB 1512" LED. IP 65 rating.

402604

30 W

CCT	Beam Angle	lm	lm/w	Finish	Dimming
.27 2700°K	.14 14°	2x1.853	61.77	.01 RAL 9006	.0 ON/OFF
	.35 35°	2x1.758	58.60	.02 RAL 7016	.1 1-10V
	.55 55°	2x1.710	57.00	.03 Matt Black	.D DALI
.30 3000°K	.14 14°	2x1.951	130.06		
	.35 35°	2x1.850	123.33		
	.55 55°	2x1.800	120.00		
.40 4000°K	.14 14°	2x2.240	149.33		
	.35 35°	2x2.131	142.06		
	.55 55°	2x2.046	136.40		





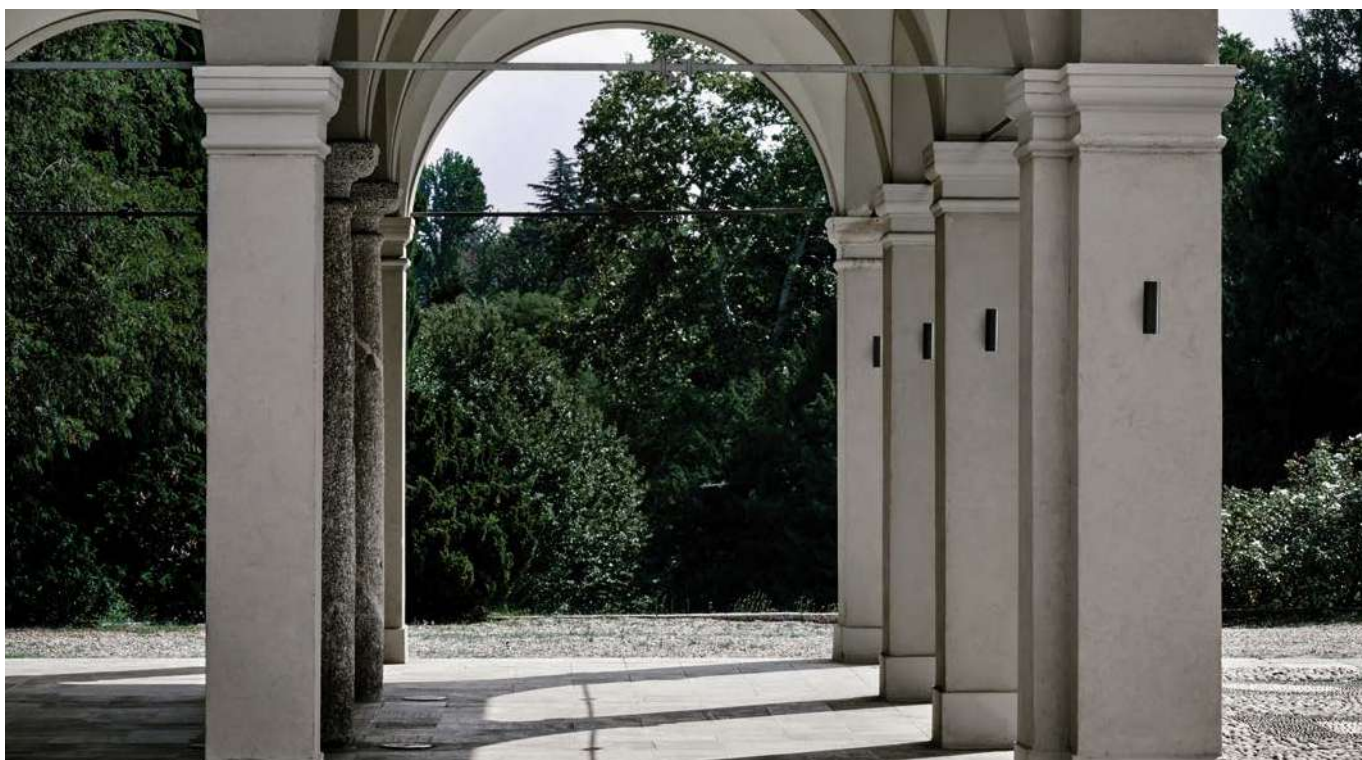

Nanowall

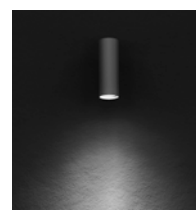
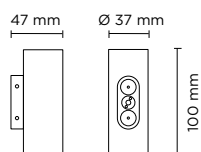

PRODUCT WEIGHT 0,35 kg



Code Example

403105 .27 .08 .01 .0

Accessories p. 189

Nanowall Round XXS 01

Wall applique for outdoor installation on a façade/wall, with one side light only. Body in anodized aluminum with phospho-chromatised and polyester powder coating, tempered safety glass, moulded silicone gasket and stainless steel screws. Constant current 350mA remote driver needed. With 1 x CREE "XP-G2" LED. IP66 rating.

403105

1 W

CCT	Beam Angle	lm	lm/w	Finish	Dimming
.27 2700°K	.08 8°	70	70.00	.01 RAL 9006	.0 ON/OFF
	.32 32°	60	60.00	.02 RAL 7016	
	.45 45°	55	55.00	.03 Matt Black	
.30 3000°K	.08 8°	75	75.00		
	.32 32°	65	65.00		
	.45 45°	60	60.00		
.40 4000°K	.08 8°	80	80.00		
	.32 32°	70	70.00		
	.45 45°	65	65.00		

Remote Driver Selection

Brand	Manufacturer code	Type	Watt	IP Rate	Number of fixtures
ALVIT Italy	AL1435S-IP	Constant current 350mA	14W	IP67	min 1 - max 8
Meanwell	LPC-20-350	Constant current 350mA	16.8W	IP67	min 4 - max 12

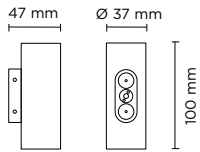

PRODUCT WEIGHT 0,35 kg



Nanowall Round XXS O2

Code Example

403106.**27**.**08**.**01**.**0**

Accessories p. 189

Wall applique for outdoor installation on a façade/wall, with up&down light. Body in anodized aluminum with phospho-chromatised and polyester powder coating, tempered safety glass, moulded silicone gasket and stainless steel screws. Constant current 350mA remote driver needed. With 2 x CREE "XP-G2" LED. IP66 rating.

403106
2x1W

CCT	Beam Angle	lm	lm/w	Finish	Dimming
.27 2700°K	.08 8°	2x70	70.00	.01 RAL 9006	.0 ON/OFF
	.32 32°	2x60	60.00	.02 RAL 7016	
	.45 45°	2x55	55.00	.03 Matt Black	
.30 3000°K	.08 8°	2x75	75.00		
	.32 32°	2x65	65.00		
	.45 45°	2x60	60.00		
.40 4000°K	.08 8°	2x80	80.00		
	.32 32°	2x70	70.00		
	.45 45°	2x65	65.00		

Remote Driver Selection

Brand	Manufacturer code	Type	Watt	IP Rate	Number of fixtures
ALVIT Italy	AL1435S-IP	Constant current 350mA	14W	IP67	min 1 - max 4
Meanwell	LPC-20-350	Constant current 350mA	16.8W	IP67	min 2 - max 6

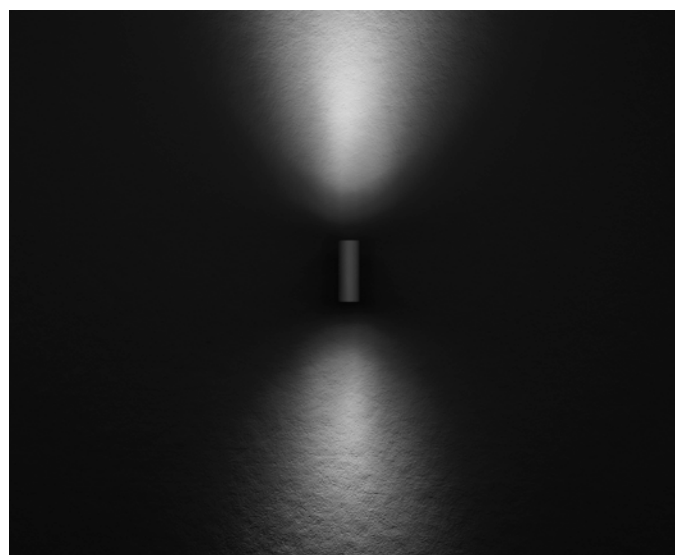
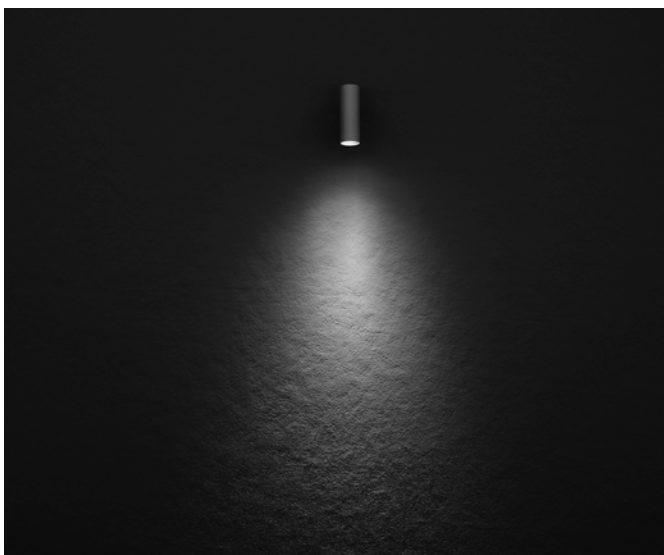

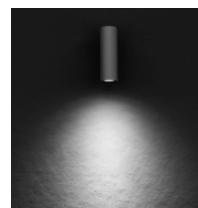
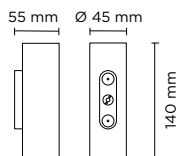

PRODUCT WEIGHT 0,60 kg



Nanowall Round XS 01

Code Example

403107, .27, .10, .01, .0

Accessories p. 189

Wall applique for outdoor installation on a façade/wall, with up&down light. Body in anodized aluminum with phospho-chromatised and polyester powder coating, tempered safety glass, moulded silicone gasket and stainless steel screws. Constant current 350mA remote driver needed. With 2 x CREE "XP-G2" LED. IP66 rating.

403107
Max 2,5W

CCT	Beam Angle	Finish	Dimming
.27 2700°K	.10 10°	.01 RAL 9006	.0 ON/OFF
	.30 30°	.02 RAL 7016	
	.45 45°	.03 Matt Black	
.30 3000°K	.10 10°		
	.30 30°		
	.45 45°		
.40 4000°K	.10 10°		
	.30 30°		
	.45 45°		

CCT	Beam Angle	350 mA LED POWER 1.2W		500 mA LED POWER 1.7W		700 mA LED POWER 2.5W	
		lm	lm/w	lm	lm/w	lm	lm/w
2700°K	10°	131	109.25	186	109.53	274	109.44
	30°	125	104.50	178	104.50	261	104.50
	45°	119	98.95	168	98.91	247	98.80
3000°K	10°	138	115.00	196	115.00	288	115.00
	30°	132	110.00	187	110.00	275	110.00
	45°	125	104.00	177	104.00	260	104.00
4000°K	10°	144	120.00	204	120.00	300	120.00
	30°	137	114.00	194	114.00	285	114.00
	45°	131	109.00	186	109.00	273	109.00

Remote Driver Selection

Brand	Manufacturer code	Type	Watt	IP Rate	Number of fixtures
ALVIT Italy	AL1435S-IP	Constant current 350mA	14W	IP67	min 1 - max 8
ALVIT Italy	AL1450S-IP	Constant current 500mA	14W	IP67	min 1 - max 6
ALVIT Italy	AL1470S-IP	Constant current 700mA	14W	IP67	min 1 - max 4

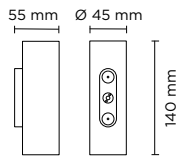

PRODUCT WEIGHT 0,60 kg



Nanowall Round XS 02

Code Example

403108, .27, .10, .01, .0

Accessories p. 189

Wall applique for outdoor installation on a façade/wall, with up&down light. Body in anodized aluminum with phospho-chromatised and polyester powder coating, tempered safety glass, moulded silicone gasket and stainless steel screws. Constant current max 700mA remote driver needed. With 2 x CREE "XP-L" LED. IP66 rating.

403108

Max
2x2,5W

CCT	Beam Angle	Finish	Dimming
.27 2700°K	.10 10°	.01 RAL 9006	.0 ON/OFF
	.30 30°	.02 RAL 7016	
	.45 45°	.03 Matt Black	
.30 3000°K	.10 10°		
	.30 30°		
	.45 45°		
.40 4000°K	.10 10°		
	.30 30°		
	.45 45°		

CCT	Beam Angle	350 mA LED POWER 2x1.2W		500 mA LED POWER 2x1.7W		700 mA LED POWER 2x2.5W	
		lm	lm/w	lm	lm/w	lm	lm/w
2700°K	10°	2x131	109.25	2x186	109.53	2x724	109.44
	30°	2x125	104.50	2x178	104.50	2x261	104.50
	45°	2x119	98.95	2x168	98.91	2x247	98.80
3000°K	10°	2x138	115.00	2x196	115.00	2x288	115.00
	30°	2x132	110.00	2x187	110.00	2x275	110.00
	45°	2x125	104.00	2x177	104.00	2x260	104.00
4000°K	10°	2x144	120.00	2x204	120.00	2x300	120.00
	30°	2x137	114.00	2x194	114.00	2x285	114.00
	45°	2x131	109.00	2x186	109.00	2x273	109.00

Remote Driver Selection

Brand	Manufacturer code	Type	Watt	IP Rate	Number of fixtures
ALVIT Italy	AL1435S-IP	Constant current 350mA	14W	IP67	min 1 - max 4
ALVIT Italy	AL1450S-IP	Constant current 500mA	14W	IP67	min 1 - max 3
ALVIT Italy	AL1470S-IP	Constant current 700mA	14W	IP67	min 1 - max 2

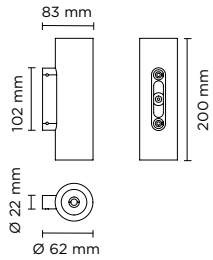

PRODUCT WEIGHT 1,30 kg



Code Example

403101 .27 .20 .01 .0

Accessories p. 189

Nanowall Round Cob 01

Wall applique for outdoor installation on a façade/wall, with one side light only. Body in anodized aluminum with phospho-chromatised and polyester powder coating, tempered safety glass, moulded silicone gasket and stainless steel screws. With 1 direct 220-240V LUMENS "EDC 38C" COB LED. IP66 rating.

403101

8W

CCT	Beam Angle	lm	lm/w	Finish	Dimming
.27 2700°K	.20 20°	380	47.50	.01 RAL 9006	.0 ON/OFF
	.40 40°	371	46.38	.02 RAL 7016	
.30 3000°K	.20 20°	400	50.00	.03 Matt Black	
	.40 40°	390	48.75		
.40 4000°K	.20 20°	410	51.25		
	.40 40°	400	50.00		

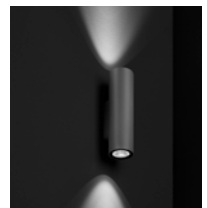
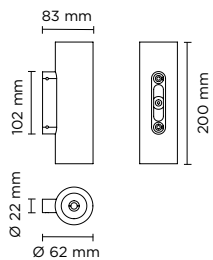

PRODUCT WEIGHT 1,30 kg



Code Example

403102 .27 .20 .01 .0

Accessories p. 189

Nanowall Round Cob 02

Wall applique for outdoor installation on a façade/wall, with up&down light. Body in anodized aluminum with phospho-chromatised and polyester powder coating, tempered safety glass, moulded silicone gasket and stainless steel screws. With 2 x direct 220-240V LUMENS "EDC 38C" COB LED. IP66 rating.

403102

2x8W

CCT	Beam Angle	lm	lm/w	Finish	Dimming
.27 2700°K	.20 20°	2x380	47.50	.01 RAL 9006	.0 ON/OFF
	.40 40°	2x371	46.38	.02 RAL 7016	
.30 3000°K	.20 20°	2x400	50.00	.03 Matt Black	
	.40 40°	2x390	48.75		
.40 4000°K	.20 20°	2x410	51.25		
	.40 40°	2x400	50.00		

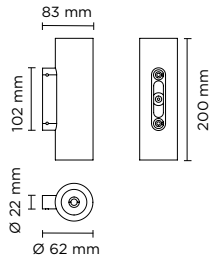

PRODUCT WEIGHT 1,30 kg



Code Example

403103.27.04.01.0

Accessories p. 189

Nanowall Round HP 01

Wall applique for outdoor installation on a façade/wall, with one side light only. Body in anodized aluminum with phospho-chromatised and polyester powder coating, tempered safety glass, moulded silicone gasket and stainless steel screws. Constant current max 700mA remote driver needed. With 1 x CREE "XHP35" LED. IP66 rating.

403103
Max 10W

CCT	Beam Angle	Finish	Dimming
.27 2700°K	.04 4°	.01 RAL 9006	.0 ON/OFF
	.10 10°	.02 RAL 7016	
	.28 28°	.03 Matt Black	
	.55 55°		
	.30 3000°K	.04 4°	
	.10 10°		
	.28 28°		
	.55 55°		
.40 4000°K	.04 4°		
	.10 10°		
	.28 28°		
	.55 55°		

CCT	Beam Angle	350 mA LED POWER 5W		500 mA LED POWER 8W		700 mA LED POWER 10W	
		lm	lm/w	lm	lm/w	lm	lm/w
2700°K	4°	500	100.00	670	83.75	897	89.70
	10°	479	95.80	642	80.25	762	76.20
	28°	464	92.80	622	77.75	836	83.60
	55°	394	78.88	529	66.09	711	71.06
3000°K	4°	510	102.00	690	86.25	907	90.69
	10°	489	97.80	662	82.75	872	87.20
	28°	474	94.80	642	80.25	846	84.60
	55°	403	80.58	546	68.21	719	71.91
4000°K	4°	520	104.00	703	87.88	930	93.00
	10°	499	99.80	676	84.50	890	89.00
	28°	484	96.80	656	82.00	863	86.30
	55°	411	82.28	558	69.70	734	73.36

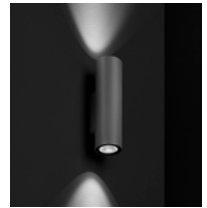

PRODUCT WEIGHT 1,30 kg

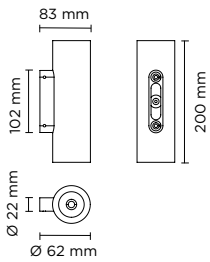

Nanowall Round HP 02

Wall applique for outdoor installation on a façade/wall, with one side light only. Body in anodized aluminum with phospho-chromatised and polyester powder coating, tempered safety glass, moulded silicone gasket and stainless steel screws. Constant current max 700mA remote driver needed. With 2 x CREE "XHP35" LED. IP66 rating.

Code Example

403104 .27 .04 .01 .0

Accessories p. 189

403104
Max
2x10W

CCT	Beam Angle	Finish	Dimming
.27 2700°K	.04 4°	.01 RAL 9006	.0 ON/OFF
	.10 10°	.02 RAL 7016	
	.28 28°	.03 Matt Black	
	.55 55°		
	.30 3000°K	.04 4°	
.30 3000°K	.10 10°		
	.28 28°		
	.55 55°		
	.40 4000°K	.04 4°	
.40 4000°K	.10 10°		
	.28 28°		
	.55 55°		

CCT	Beam Angle	350 mA LED POWER 2x5W		500 mA LED POWER 2x8W		700 mA LED POWER 2x10W	
		lm	lm/w	lm	lm/w	lm	lm/w
2700°K	4°	2 x 500	100.00	2 x 670	83.75	2 x 897	89.70
	10°	2 x 479	95.80	2 x 642	80.25	2 x 762	76.20
	28°	2 x 464	92.80	2 x 622	77.75	2 x 836	83.60
	55°	2 x 394	78.88	2 x 529	65.92	2 x 711	71.06
3000°K	4°	2 x 510	102.00	2 x 690	86.25	2 x 907	90.69
	10°	2 x 489	97.80	2 x 662	82.75	2 x 872	87.20
	28°	2 x 474	94.80	2 x 642	80.25	2 x 846	84.60
	55°	2 x 403	80.58	2 x 546	68.21	2 x 719	71.91
4000°K	4°	2 x 520	104.00	2 x 703	87.88	2 x 930	93.00
	10°	2 x 499	99.80	2 x 676	84.50	2 x 890	89.00
	28°	2 x 484	96.80	2 x 656	82.00	2 x 863	86.30
	55°	2 x 411	82.28	2 x 558	69.70	2 x 734	73.36

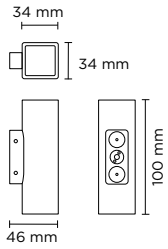

PRODUCT WEIGHT 0,40 kg



Code Example

403109 .27 .08 .01 .0

Accessories p. 189

Nanowall Square XXS 01

Wall applique for outdoor installation on a façade/wall, with one side light only. Body in anodized aluminum with phospho-chromatised and polyester powder coating, tempered safety glass, moulded silicone gasket and stainless steel screws. Constant current 350mA remote driver needed. With 1 x CREE "XP-G2" LED. IP66 rating.

403109
1W

CCT	Beam Angle	Im	Im/w	Finish	Dimming
.27 2700°K	.08 8°	70	70.00	.01 RAL 9006	.0 ON/OFF
	.32 32°	60	60.00	.02 RAL 7016	
	.45 45°	55	55.00	.03 Matt Black	
.30 3000°K	.08 8°	75	75.00		
	.32 32°	65	65.00		
	.45 45°	60	60.00		
.40 4000°K	.08 8°	80	80.00		
	.32 32°	70	70.00		
	.45 45°	65	65.00		

Remote Driver Selection

Brand	Manufacturer code	Type	Watt	IP Rate	Number of fixtures
ALVIT Italy	AL1435S-IP	Constant current 350mA	14W	IP67	min 1 - max 8
Meanwell	LPC-20-350	Constant current 350mA	16.8W	IP67	min 4 - max 12



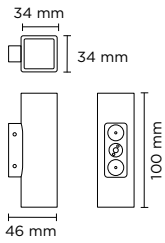

PRODUCT WEIGHT 0,40 kg



Code Example

403110 .27 .08 .01 0

Accessories p. 189

403110
2x1W

Nanowall Square XXS 02

Wall applique for outdoor installation on a façade/wall, with up&down light. Body in anodized aluminum with phospho-chromatised and polyester powder coating, tempered safety glass, moulded silicone gasket and stainless steel screws. Constant current 350mA remote driver needed. With 2 x CREE "XP-G2" LED. IP66 rating.

CCT	Beam Angle	lm	lm/w	Finish	Dimming
.27 2700°K	.08 8°	2x70	70.00	.01 RAL 9006	.0 ON/OFF
	.32 32°	2x60	60.00	.02 RAL 7016	
	.45 45°	2x55	55.00	.03 Matt Black	
.30 3000°K	.08 8°	2x75	75.00		
	.32 32°	2x65	65.00		
	.45 45°	2x60	60.00		
.40 4000°K	.08 8°	2x80	80.00		
	.32 32°	2x70	70.00		
	.45 45°	2x65	65.00		

Remote Driver Selection

Brand	Manufacturer code	Type	Watt	IP Rate	Number of fixtures
ALVIT Italy	AL1435S-IP	Constant current 350mA	14W	IP67	min 1 - max 4
Meanwell	LPC-20-350	Constant current 350mA	16.8W	IP67	min 2 - max 6



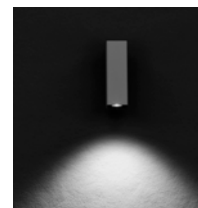
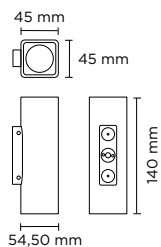

PRODUCT WEIGHT 0,65 kg



Code Example

403111.27.10.01.0

Accessories p. 189

Nanowall Square XS 01

Wall applique for outdoor installation on a façade/wall, with one side light only. Body in anodized aluminum with phospho-chromatised and polyester powder coating, tempered safety glass, moulded silicone gasket and stainless steel screws. Constant current max 700mA remote driver needed. With 1 x CREE "XP-L" LED. IP66 rating.

403111
Max 2,5W

CCT	Beam Angle	Finish	Dimming
.27 2700°K	.10 10°	.01 RAL 9006	.0 ON/OFF
	.30 30°	.02 RAL 7016	
	.45 45°	.03 Matt Black	
.30 3000°K	.10 10°		
	.30 30°		
	.45 45°		
.40 4000°K	.10 10°		
	.30 30°		
	.45 45°		

CCT	Beam Angle	350 mA LED POWER 1.2W		500 mA LED POWER 1.7W		700 mA LED POWER 2.5W	
		lm	lm/w	lm	lm/w	lm	lm/w
2700°K	10°	131	109.25	186	109.52	273	109.44
	30°	125	104.50	178	104.50	261	104.50
	45°	119	98.95	168	98.91	247	98.80
3000°K	10°	138	115.00	196	115.00	288	115.00
	30°	132	110.00	187	110.00	275	110.00
	45°	125	104.00	177	104.00	260	104.00
4000°K	10°	144	120.00	204	120.00	300	120.00
	30°	137	114.00	194	114.00	285	114.00
	45°	131	109.00	186	109.00	273	109.00

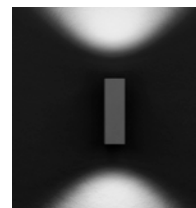
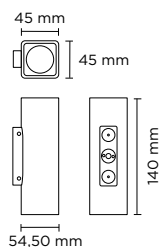

PRODUCT WEIGHT 0,65 kg



Nanowall Square XS 02

Code Example

403112 . 27 . 10 . 01 . 0

Accessories p. 189

Wall applique for outdoor installation on a façade/wall, with up&down light. Body in anodized aluminum with phospho-chromatised and polyester powder coating, tempered safety glass, moulded silicone gasket and stainless steel screws. Constant current max 700mA remote driver needed. With 2 x CREE "XP-L" LED. IP66 rating.

403112
Max
2x2,5W

CCT	Beam Angle	Finish	Dimming
.27 2700°K	.10 10°	.01 RAL 9006	.0 ON/OFF
	.30 30°	.02 RAL 7016	
	.45 45°	.03 Matt Black	
.30 3000°K	.10 10°		
	.30 30°		
	.45 45°		
.40 4000°K	.10 10°		
	.30 30°		
	.45 45°		

CCT	Beam Angle	350 mA LED POWER 2x1.2W		500 mA LED POWER 2x1.7W		700 mA LED POWER 2x2.5W	
		lm	lm/w	lm	lm/w	lm	lm/w
2700°K	10°	2x131	109.25	2x186	109.52	2x273	109.44
	30°	2x125	104.50	2x178	104.50	2x261	104.50
	45°	2x119	98.95	2x168	98.91	2x247	98.80
3000°K	10°	2x138	115.00	2x196	115.00	2x288	115.00
	30°	2x132	110.00	2x187	110.00	2x275	110.00
	45°	2x125	104.00	2x177	104.00	2x260	104.00
4000°K	10°	2x144	120.00	2x204	120.00	2x300	120.00
	30°	2x137	114.00	2x194	114.00	2x285	114.00
	45°	2x131	109.00	2x186	109.00	2x273	109.00

Remote Driver Selection

Brand	Manufacturer code	Type	Watt	IP Rate	Number of fixtures
ALVIT Italy	AL1435S-IP	Constant current 350mA	14W	IP67	min 1 - max 4
ALVIT Italy	AL1450S-IP	Constant current 500mA	14W	IP67	min 1 - max 3
ALVIT Italy	AL1470S-IP	Constant current 700mA	14W	IP67	min 1 - max 2

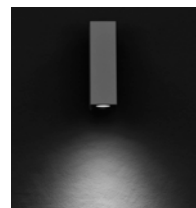
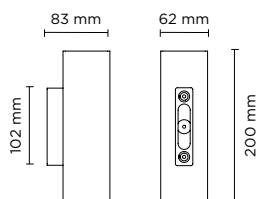

PRODUCT WEIGHT 1,60 kg



Code Example

403113 .27 .20 .01 .0

Accessories p. 189

Nanowall Square Cob 01

Wall applique for outdoor installation on a façade/wall, with one side light only. Body in anodized aluminum with phospho-chromatised and polyester powder coating, tempered safety glass, moulded silicone gasket and stainless steel screws. With 1 direct 220-240V LUMENS "EDC 38C" COB LED. IP66 rating

403113

8W

CCT	Beam Angle	lm	lm/w
.27 2700°K	.20 20°	380	47.50
	.40 40°	371	46.38
.30 3000°K	.20 20°	400	50.00
	.40 40°	390	48.75
.40 4000°K	.20 20°	410	51.25
	.40 40°	400	50.00

Finish

- .01 RAL 9006
- .02 RAL 7016
- .03 Matt Black

Dimming

- .0 ON/OFF

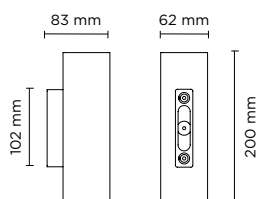

PRODUCT WEIGHT 1,60 kg



Code Example

403114 .27 .20 .01 .0

Accessories p. 189

Nanowall Square Cob 02

Wall applique for outdoor installation on a façade/wall, with up&down light. Body in anodized aluminum with phospho-chromatised and polyester powder coating, tempered safety glass, moulded silicone gasket and stainless steel screws. With 2 x direct 220-240V LUMENS "EDC 38C" COB LED. IP66 rating.

403114

2x8W

CCT	Beam Angle	lm	lm/w
.27 2700°K	.20 20°	2x380	47.50
	.40 40°	2x371	46.38
.30 3000°K	.20 20°	2x400	50.00
	.40 40°	2x390	48.75
.40 4000°K	.20 20°	2x410	51.25
	.40 40°	2x400	50.00

Finish

- .01 RAL 9006
- .02 RAL 7016
- .03 Matt Black

Dimming

- .0 ON/OFF

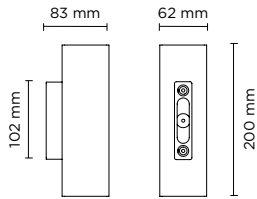

PRODUCT WEIGHT 1,60 kg



Nanowall Square HP 01

Code Example

403115.27.04.01.0

Accessories p. 189

Wall applique for outdoor installation on a façade/wall, with one side light only. Body in anodized aluminum with phospho-chromatised and polyester powder coating, tempered safety glass, moulded silicone gasket and stainless steel screws. Constant current max 700mA remote driver needed. With 1 x CREE "XHP35" LED. IP66 rating.

403115
Max 10W

CCT	Beam Angle	Finish	Dimming
.27 2700°K	.04 4°	.01 RAL 9006	.0 ON/OFF
	.10 10°	.02 RAL 7016	
	.28 28°	.03 Matt Black	
	.55 55°		
.30 3000°K	.04 4°		
	.10 10°		
	.28 28°		
	.55 55°		
.40 4000°K	.04 4°		
	.10 10°		
	.28 28°		
	.55 55°		

CCT	Beam Angle	350 mA LED POWER 5W		500 mA LED POWER 8W		700 mA LED POWER 10W	
		lm	lm/w	lm	lm/w	lm	lm/w
2700°K	4°	500	100.00	670	83.75	897	89.70
	10°	479	95.80	642	80.25	762	76.20
	28°	464	92.80	622	77.75	836	83.60
	55°	394	78.88	529	65.92	711	71.06
3000°K	4°	510	102.00	690	86.25	907	90.69
	10°	489	97.80	662	82.75	872	87.20
	28°	474	94.80	642	80.25	846	84.60
	55°	403	80.58	546	68.21	719	71.91
4000°K	4°	520	104.00	703	87.88	930	93.00
	10°	499	99.80	676	84.50	890	89.00
	28°	484	96.80	656	82.00	863	86.30
	55°	411	82.28	558	69.70	734	73.36

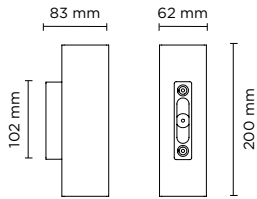

PRODUCT WEIGHT 1,60 kg



Nanowall Square HP 02

Code Example

403116.27.04.01.0

Accessories p. 189

Wall applique for outdoor installation on a façade/wall, with up&down light. Body in anodized aluminum with phospho-chromatised and polyester powder coating, tempered safety glass, moulded silicone gasket and stainless steel screws. Constant current max 700mA remote driver needed. With 2 x CREE "XHP35" LED. IP66 rating.

403116
Max
2x10W

CCT	Beam Angle	Finish	Dimming
.27 2700°K	.04 4°	.01 RAL 9006	.0 ON/OFF
	.10 10°	.02 RAL 7016	
	.28 28°	.03 Matt Black	
	.55 55°		
.30 3000°K	.04 4°		
	.10 10°		
	.28 28°		
	.55 55°		
.40 4000°K	.04 4°		
	.10 10°		
	.28 28°		
	.55 55°		

CCT	Beam Angle	350 mA LED POWER 2x5W		500 mA LED POWER 2x8W		700 mA LED POWER 2x10W	
		lm	lm/w	lm	lm/w	lm	lm/w
2700°K	4°	2 x 500	100.00	2 x 670	83.75	2 x 897	89.70
	10°	2 x 479	95.80	2 x 642	80.25	2 x 762	76.20
	28°	2 x 464	92.80	2 x 622	77.75	2 x 836	83.60
	55°	2 x 394	78.88	2 x 529	66.09	2 x 711	71.06
3000°K	4°	2 x 510	102.00	2 x 690	86.25	2 x 907	90.69
	10°	2 x 489	97.80	2 x 662	82.75	2 x 872	87.20
	28°	2 x 474	94.80	2 x 642	80.25	2 x 846	84.60
	55°	2 x 403	80.58	2 x 546	68.21	2 x 719	71.91
4000°K	4°	2 x 520	104.00	2 x 703	87.88	2 x 930	93.00
	10°	2 x 499	99.80	2 x 676	84.50	2 x 890	89.00
	28°	2 x 484	96.80	2 x 656	82.00	2 x 863	86.30
	55°	2 x 411	82.28	2 x 558	69.70	2 x 734	73.36



INTEGRATED ACCESSORIES

403115 . 27 . 18 . 10 . 01 . _ _

Built-in accessories to be requested when ordering
example 403115.27.18.10.01.0.HC

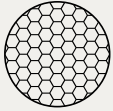

.HC

HONEYCOMB

A honeycomb structure designed to control the light beam, reduce glare, and prevent direct exposure to the light source.

Compatible for all products of the series.



.GS

STANDARD GLARE SHIELD

Minimizes glare and optimizes beam direction for precise lighting.

Available for:

ALL NANOWALL ROUND XS ITEM

ALL NANOWALL ROUND HP ITEM

ALL NANOWALL SQUARE XS ITEM

ALL NANOWALL SQUARE HP ITEM

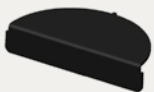

.SC

SUPER CONFORT GLARE SHIELD

Advanced glare-control accessory engineered to significantly reduce direct luminance and improve visual comfort. Optimizes beam uniformity while maintaining precise light distribution.

Available for:

ALL NANOWALL ROUND XS ITEM

ALL NANOWALL ROUND HP ITEM

ALL NANOWALL SQUARE XS ITEM

ALL NANOWALL SQUARE HP ITEM



Tech

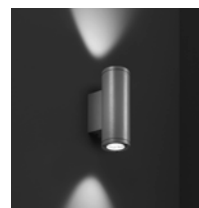
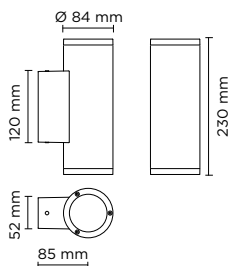

PRODUCT WEIGHT 1,30 kg



Code Example

401001.00.00.01.0

Tech Mini O2 Round GU10

Round up&down luminaire for outdoor installation on a façade/wall. Phospho-chromatised and polyester powder coated die-cast copper-free aluminium body, tempered safety glass, moulded silicone gasket and stainless steel screws. GU10 LED / halogen. IP65 rating.

401001
Max 50W

Light Source	Light Color	Light Beam Option	Finish	Dimming
GU10 LED / HALOGEN	SEE BULB FEATURES	SEE BULB FEATURES	.01 RAL 9006	.0 ON/OFF
			.02 RAL 7016	
			.03 Matt Black	

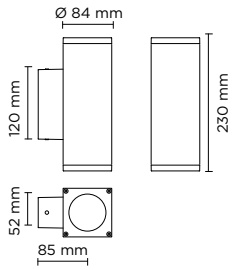

PRODUCT WEIGHT 1,40 kg



Code Example

401002.00.00.01.0

Tech Mini 02 Square GU10

Square up&down luminaire for outdoor installation on a façade/wall. Phospho-chromatised and polyester powder coated die-cast copper-free aluminium body, tempered safety glass, moulded silicone gasket and stainless steel screws. GU10 LED / halogen. IP65 rating.

401002
Max 50W

Light Source	Light Color	Light Beam Option	Finish	Dimming
GU10 LED / HALOGEN	SEE BULB FEATURES	SEE BULB FEATURES	.01 RAL 9006	.0 ON/OFF
			.02 RAL 7016	
			.03 Matt Black	

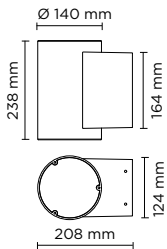

PRODUCT WEIGHT 3,00 kg



Code Example

401012.27.10.01.0

Tech Medium 01 Round

Round wall mounted luminaire for outdoor installation on a façade/wall, with light distribution downward only. Phospho-chromatised and polyester powder coated die-cast copper-free aluminium body, tempered safety glass, moulded silicone gasket and stainless steel screws. Built-in LED driver 220-240V 50-60Hz, with 5 CREE XP-G3 LED. IP65 rating.

401012
8W

CCT	Beam Angle	lm	lm/w	Finish	Dimming
.27 2700°K	.10 10°	684	85.50	.01 RAL 9006	.0 ON/OFF
	.30 30°	650	81.25	.02 RAL 7016	
	.45 45°	618	77.25	.03 Matt Black	
.30 3000°K	.10 10°	720	90.33		
	.30 30°	684	85.50		
	.45 45°	650	81.25		
.40 4000°K	.10 10°	750	93.75		
	.30 30°	713	89.13		
	.45 45°	677	84.63		

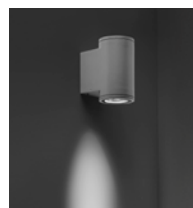
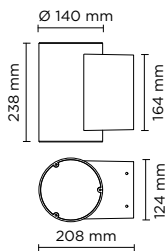

PRODUCT WEIGHT 3,00 kg



Code Example

401017 .30 .10 .01 .0

Tech Medium 01 Round Pro

Round wall mounted luminaire for outdoor installation on a façade/wall, with light distribution downward only. Phospho-chromatised and polyester powder coated die-cast copper-free aluminium body, tempered safety glass, moulded silicone gasket and stainless steel screws. Built-in LED driver 220-240V 50-60Hz, with 5 CREE XP-L LED. IP65 rating.

401017
14W

CCT*	Beam Angle	lm	lm/w	Finish	Dimming
.30 3000°K	.10 10°	1.300	92.86	.01 RAL 9006	.0 ON/OFF
	.30 30°	1.230	87.86	.02 RAL 7016	
	.45 45°	1.170	83.57	.03 Matt Black	

*Other light colors available on request: Neutral-white

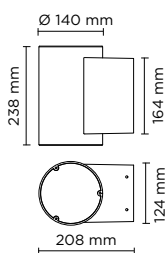

PRODUCT WEIGHT 3,00 kg



Code Example

401004 .27 .10 .01 .0

Tech Medium 02 Round

Round up&down luminaire for outdoor installation on a façade/wall. Phospho-chromatised and polyester powder coated die-cast copper-free aluminium body, tempered safety glass, moulded silicone gasket and stainless steel screws. Built-in LED driver 220-240V 50-60Hz, with 2 x 5 CREE XP-G3 LED. IP65 rating.

401004
2x8W

CCT	Beam Angle	lm	lm/w	Finish	Dimming
.27 2700°K	.10 10°	2 x 684	85.50	.01 RAL 9006	.0 ON/OFF
	.30 30°	2 x 650	81.25		
	.45 45°	2 x 618	77.25		
.30 3000°K	.10 10°	2 x 720	90.00	.02 RAL 7016	.D DALI
	.30 30°	2 x 684	85.50		
	.45 45°	2 x 650	81.25		
.40 4000°K	.10 10°	2 x 750	93.75	.03 Matt Black	
	.30 30°	2 x 713	89.13		
	.45 45°	2 x 677	84.63		

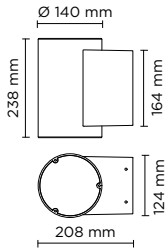

PRODUCT WEIGHT 3,00 kg



Code Example

401016.30.10.01.0

Tech Medium O2 Round Pro

Round up&down luminaire for outdoor installation on a façade/wall. Phospho-chromatised and polyester powder coated die-cast copper-free aluminium body, tempered safety glass, moulded silicone gasket and stainless steel screws. Built-in LED driver 220-240V 50-60Hz, with 2 x 5 CREE XP-L LED. IP65 rating.

401016
2x14W

CCT*	Beam Angle	lm	lm/w	Finish	Dimming
.30 3000°K	.10 10°	2x1.300	92.86	.01 RAL 9006	.0 ON/OFF
	.30 30°	2x1.230	87.86	.02 RAL 7016	
	.45 45°	2x1.170	83.57	.03 Matt Black	

*Other light colors available on request: Neutral-white

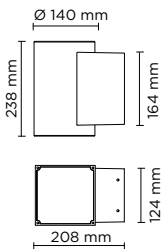

PRODUCT WEIGHT 3,00 kg



Code Example

401014.27.10.01.0

Tech Medium O1 Square

Square wall mounted luminaire for outdoor installation on a façade/wall, with light distribution downward only. Phospho-chromatised and polyester powder coated die-cast copper-free aluminium body, tempered safety glass, moulded silicone gasket and stainless steel screws. Built-in LED driver 220-240V 50-60Hz, with 5 CREE XP-G3 LED. IP65 rating.

401014
8W

CCT	Beam Angle	lm	lm/w	Finish	Dimming
.27 2700°K	.10 10°	684	85.50	.01 RAL 9006	.0 ON/OFF
	.30 30°	650	81.25	.02 RAL 7016	
	.45 45°	618	77.25	.03 Matt Black	
.30 3000°K	.10 10°	720	90.00		
	.30 30°	684	85.50		
	.45 45°	650	81.25		
.40 4000°K	.10 10°	750	93.75		
	.30 30°	713	89.13		
	.45 45°	677	84.63		

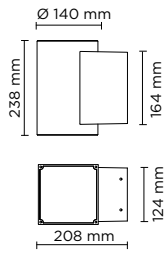

PRODUCT WEIGHT 3,00 kg



Code Example

401019.30.10.01.0

Tech Medium O1 Square Pro

Square wall mounted luminaire for outdoor installation on a façade/wall, with light distribution downward only. Phospho-chromatised and polyester powder coated die-cast copper-free aluminium body, tempered safety glass, moulded silicone gasket and stainless steel screws. Built-in LED driver 220-240V 50-60Hz, with 5 CREE XP-L LED. IP65 rating.

401019
14W

CCT*	Beam Angle	lm	lm/w	Finish	Dimming
.30 3000°K	.10 10°	1.300	92.86	.01 RAL 9006	.0 ON/OFF
	.30 30°	1.230	87.86	.02 RAL 7016	
	.45 45°	1.170	83.57	.03 Matt Black	

*Other light colors available on request: Neutral-white

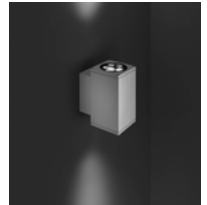
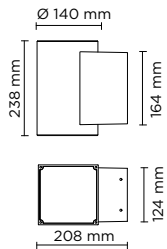

PRODUCT WEIGHT 3,00 kg



Code Example

401006.27.10.01.0

Tech Medium O2 Square

Square up&down luminaire for outdoor installation on a façade/wall. Phospho-chromatised and polyester powder coated die-cast copper-free aluminium body, tempered safety glass, moulded silicone gasket and stainless steel screws. Built-in LED driver 220-240V 50-60Hz, with 2 x 5 CREE XP-G3 LED. IP65 rating.

401006
2x8W

CCT	Beam Angle	lm	lm/w	Finish	Dimming
.27 2700°K	.10 10°	2 x 684	85.50	.01 RAL 9006	.0 ON/OFF
	.30 30°	2 x 650	81.25	.02 RAL 7016	
	.45 45°	2 x 618	77.25	.03 Matt Black	
.30 3000°K	.10 10°	2 x 720	90.00		
	.30 30°	2 x 684	85.50		
	.45 45°	2 x 650	81.25		
.40 4000°K	.10 10°	2 x 750	93.75		
	.30 30°	2 x 713	89.13		
	.45 45°	2 x 677	84.63		

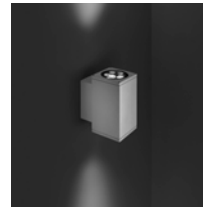
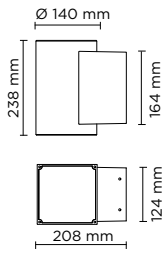

PRODUCT WEIGHT 3,00 kg



Code Example

401018 .30 .10 .01 .0

Tech Medium O2 Square Pro

Square up&down luminaire for outdoor installation on a façade/wall. Phospho-chromatised and polyester powder coated die-cast copper-free aluminium body, tempered safety glass, moulded silicone gasket and stainless steel screws. Built-in LED driver 220-240V 50-60Hz, with 2 x 5 CREE XP-L LED. IP65 rating.

401018
2x14W

CCT*	Beam Angle	lm	lm/w	Finish	Dimming
.30 3000°K	.10 10°	2x1.300	92.86	.01 RAL 9006	.0 ON/OFF
	.30 30°	2x1.230	87.86	.02 RAL 7016	
	.45 45°	2x1.170	83.57	.03 Matt Black	

*Other light colors available on request: Neutral-white

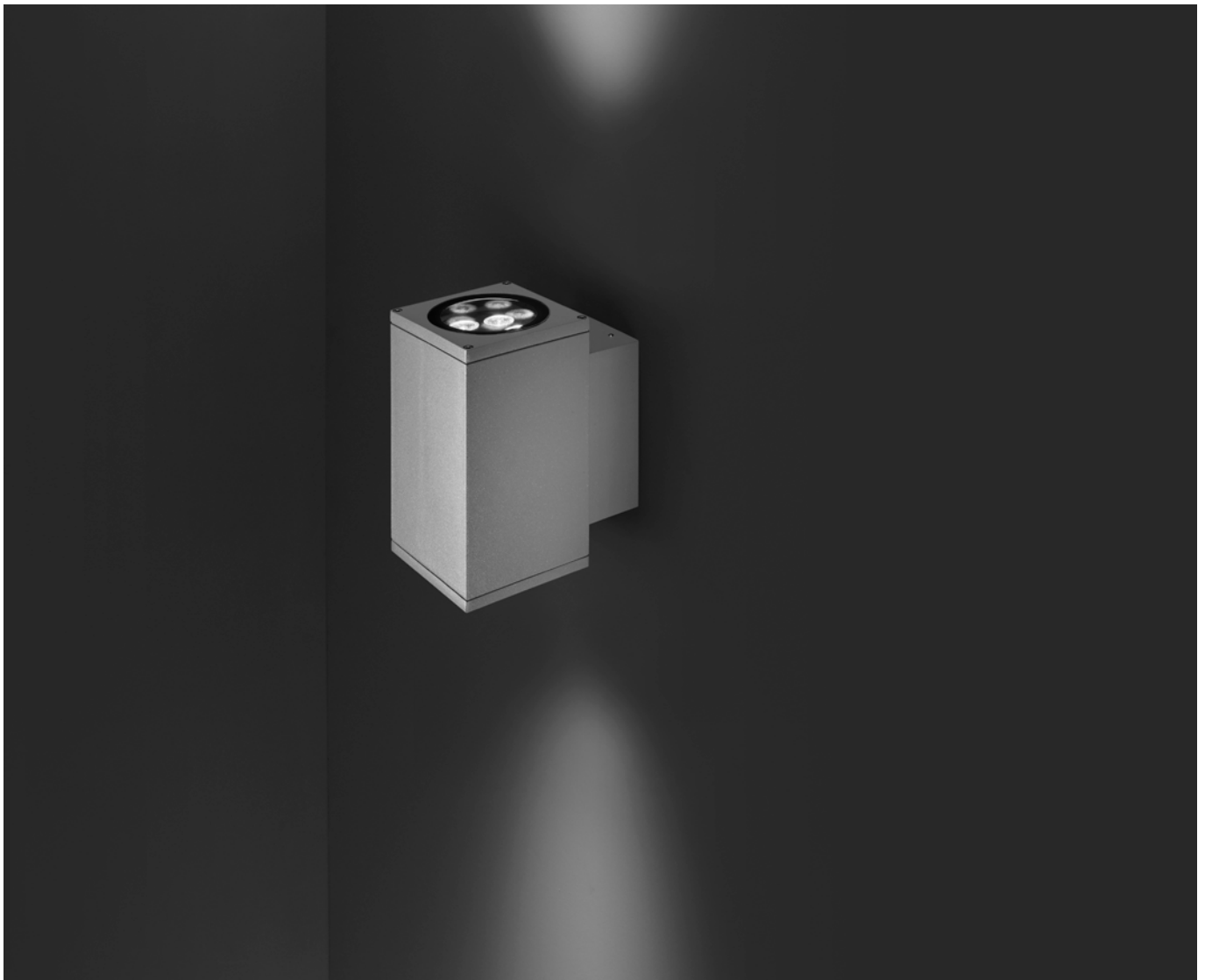



Wallbox

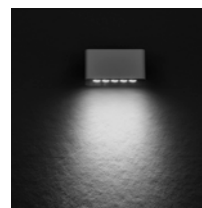
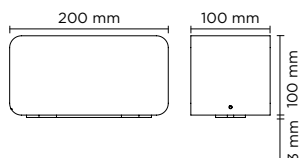

PRODUCT WEIGHT 1,70 kg

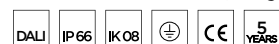

Code Example

403201.27.11.01.0

Wallbox Mini Hp 01

Wall applique for outdoor wall installation, with one side light distribution. Luminaire body is made of extruded copper-free aluminum, secured with die-cast aluminum base, tempered safety glass and stainless steel screws. Built-in LED driver 220-240V 50-60Hz, with nr. 5 CREE XP-G3 LED. IP66 rating.

403201
7W

CCT	Beam Angle	lm	lm/w	Finish	Dimming
.27 2700°K	.11 11°	550	78.57	.01 RAL 9006	.0 ON/OFF
	.30 30°	525	75.00	.02 RAL 7016	.D DALI
	.60 60°	500	71.43	.03 RAL 9005	
	.E1 45°x10°	520	74.28		
.30 3000°K	.11 11°	560	80.00		
	.30 30°	535	76.43		
	.60 60°	510	72.86		
	.E1 45°x10°	530	75.72		
.40 4000°K	.11 11°	570	81.43		
	.30 30°	545	77.86		
	.60 60°	520	74.28		
	.E1 45°x10°	540	77.14		

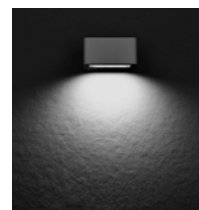
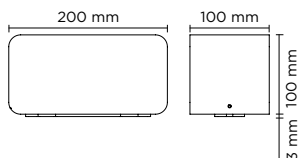

PRODUCT WEIGHT 1,70 kg

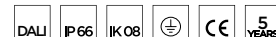

Code Example

403202 .27 .SW .01 .0

Wallbox Mini Symmetric 01

Wall applique for outdoor wall installation, with one side light distribution. Luminaire body is made of extruded copper-free aluminum, secured with die-cast aluminum base, tempered safety glass and stainless steel screws. Symmetrical wide light distribution. Built-in LED driver 220-240V 50-60Hz, with 20 x mid-power SAMSUNG 2835 LED. IP66 rating.

403202

8W

CCT	Beam Angle	Im	Im/w	Finish	Dimming
.27 2700°K	.SW symmetric wide 110°	560	70.00	.01 RAL 9006	.0 ON/OFF
.30 3000°K	.SW symmetric wide 110°	570	71.25	.02 RAL 7016	.D DALI
.40 4000°K	.SW symmetric wide 110°	590	73.75	.03 RAL 9005	

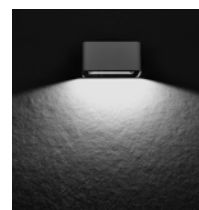
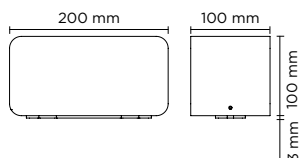

PRODUCT WEIGHT 1,70 kg

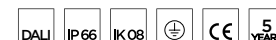

Code Example

403203 .27 .AF .01 .0

Wallbox Mini Asymmetric 01

Wall applique for outdoor wall installation, with one side light distribution. Luminaire body is made of extruded copper-free aluminum, secured with die-cast aluminum base, tempered safety glass and stainless steel screws. Asymmetrical wide light distribution. Built-in LED driver 220-240V 50-60Hz, with 20 x mid-power SAMSUNG 2835 LED. IP66 rating.

403203

8W

CCT	Beam Angle	Im	Im/w	Finish	Dimming
.27 2700°K	.AF asymm. forward 110°x70°	560	70.00	.01 RAL 9006	.0 ON/OFF
	.AB asymm. backward 110°x70°	560	70.00		
.30 3000°K	.AF asymm. forward 110°x70°	570	71.25	.02 RAL 7016	.D DALI
	.AB asymm. backward 110°x70°	570	71.25		
.40 4000°K	.AF asymm. forward 110°x70°	590	73.75	.03 RAL 9005	
	.AB asymm. backward 110°x70°	590	71.25		

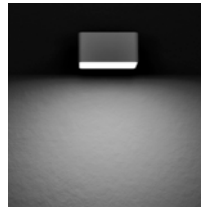
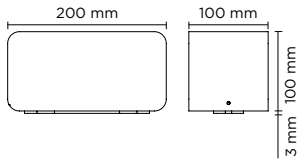

PRODUCT WEIGHT 1,70 kg



Code Example

403204.27.DF.01.0

Wallbox Mini Diffused 01

Wall applique for outdoor wall installation, with one side light distribution. Luminaire body is made of extruded copper-free aluminum, secured with die-cast aluminum base, tempered safety glass and stainless steel screws. Diffused light distribution. Built-in LED driver 220-240V 50-60Hz, with 20 x mid-power SAMSUNG 2835 LED. IP66 rating.

403204

8W

CCT	Beam Angle	lm	lm/w	Finish	Dimming
.27 2700°K	.DF Diffused	200	25.00	.01 RAL 9006	.0 ON/OFF
.30 3000°K	.DF Diffused	210	26.25	.02 RAL 7016	.D DALI
.40 4000°K	.DF Diffused	220	27.50	.03 RAL 9005	

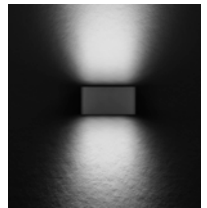
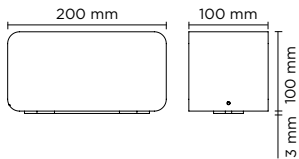

PRODUCT WEIGHT 1,70 kg



Code Example

403205.27.11.01.0

Wallbox Mini Hp 02

Wall applique for outdoor wall installation, with up&down light distribution. Luminaire body is made of extruded copper-free aluminum, secured with die-cast aluminum base, tempered safety glass and stainless steel screws. Built-in LED driver 220-240V 50-60Hz, with nr. 10 CREE XP-G3 LED. IP66 rating.

403205

14W

CCT	Beam Angle	lm	lm/w	Finish	Dimming
.27 2700°K	.11 11°	2x550	78.57	.01 RAL 9006 .02 RAL 7016 .03 RAL 9005	.0 ON/OFF .D DALI
	.30 30°	2x525	75.00		
	.60 60°	2x500	71.43		
	.E1 45°x10°	2x520	74.28		
.30 3000°K	.11 11°	2x560	80.00		
	.30 30°	2x535	76.43		
	.60 60°	2x510	72.86		
	.E1 45°x10°	2x530	75.72		
.40 4000°K	.11 11°	2x570	81.43		
	.30 30°	2x545	77.86		
	.60 60°	2x520	74.28		
	.E1 45°x10°	2x540	77.14		

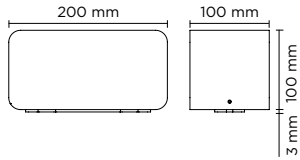

PRODUCT WEIGHT 1,70 kg



Code Example

403206.27.SW.01.0

Wallbox Mini Symmetric 02

Wall applique for outdoor wall installation, with up&down light distribution. Luminaire body is made of extruded copper-free aluminum, secured with die-cast aluminum base, tempered safety glass and stainless steel screws. Symmetrical wide light distribution. Built-in LED driver 220-240V 50-60Hz, with 40 x mid-power SAMSUNG 2835 LED. IP66 rating.

403206

16W

CCT	Beam Angle	Im	Im/w	Finish	Dimming
.27 2700°K	.SW symm. wide 110°	2x560	70.00	.01 RAL 9006	.0 ON/OFF
.30 3000°K	.SW symm. wide 110°	2x570	71.25	.02 RAL 7016	.D DALI
.40 4000°K	.SW symm. wide 110°	2x590	73.75	.03 RAL 9005	

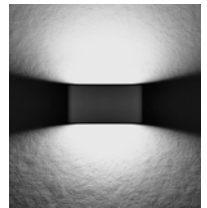
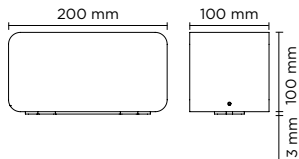

PRODUCT WEIGHT 1,70 kg

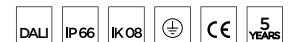

Code Example

403207.27.AF.01.0

Wallbox Mini Asymmetric 02

Wall applique for outdoor wall installation, with up&down light distribution. Luminaire body is made of extruded copper-free aluminum, secured with die-cast aluminum base, tempered safety glass and stainless steel screws. Asymmetrical wide light distribution. Built-in LED driver 220-240V 50-60Hz, with 40 x mid-power SAMSUNG 2835 LED. IP66 rating.

403207

16W

CCT	Beam Angle	Im	Im/w	Finish	Dimming
.27 2700°K	.AF asymm. forward 110°x70°	2x560	70.00	.01 RAL 9006	.0 ON/OFF
	.AB asymm. backward 110°x70°	2x560	70.00		
.30 3000°K	.AF asymm. forward 110°x70°	2x570	71.25	.02 RAL 7016	.D DALI
	.AB asymm. backward 110°x70°	2x570	71.25		
.40 4000°K	.AF asymm. forward 110°x70°	2x590	73.75	.03 RAL 9005	
	.AB asymm. backward 110°x70°	2x590	73.75		

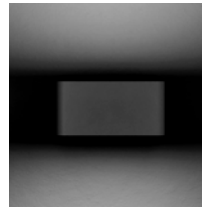
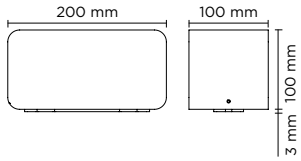

PRODUCT WEIGHT 1,70 kg



Code Example

403208.27.DF.01.0

Wallbox Mini Diffused O2

Wall applique for outdoor wall installation, with up&down light distribution. Luminaire body is made of extruded copper-free aluminum, secured with die-cast aluminum base, tempered safety glass and stainless steel screws. Diffused light distribution. Built-in LED driver 220-240V 50-60Hz, with 40 x mid-power SAMSUNG 2835 LED. IP66 rating.

CCT	Beam Angle	Im	Im/w	Finish	Dimming
403208 16W	.27 2700°K .DF Diffused	2x200	25.00	.01 RAL 9006	.0 ON/OFF
	.30 3000°K .DF Diffused	2x210	26.25	.02 RAL 7016	.D DALI
	.40 4000°K .DF Diffused	2x220	27.50	.03 RAL 9005	

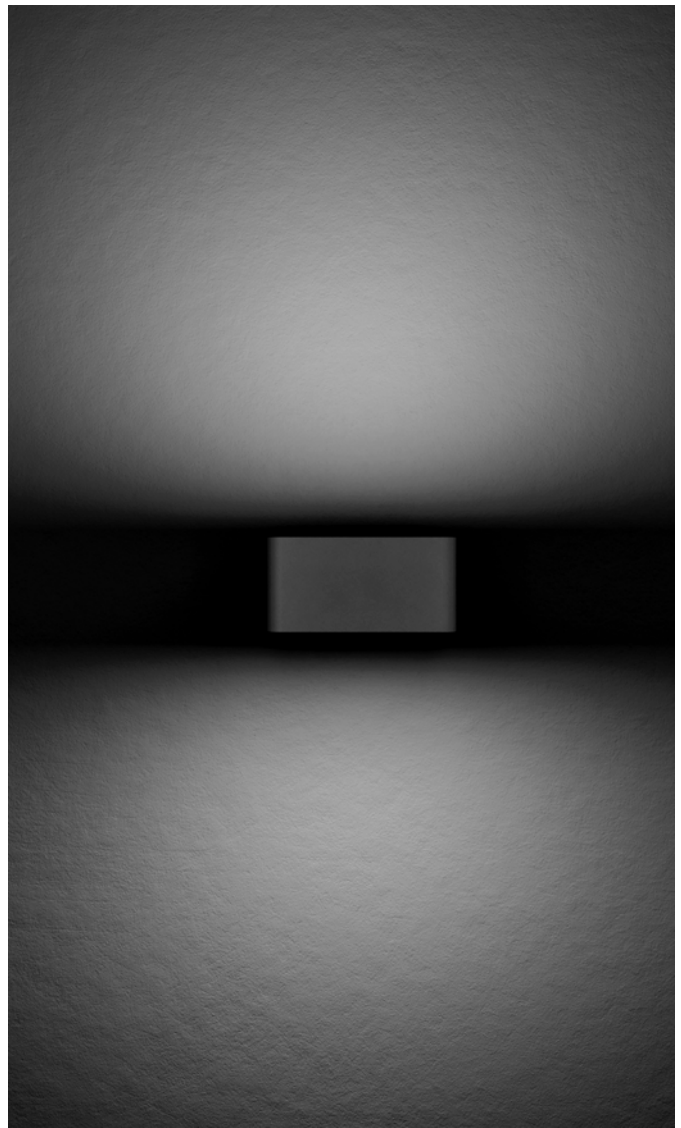
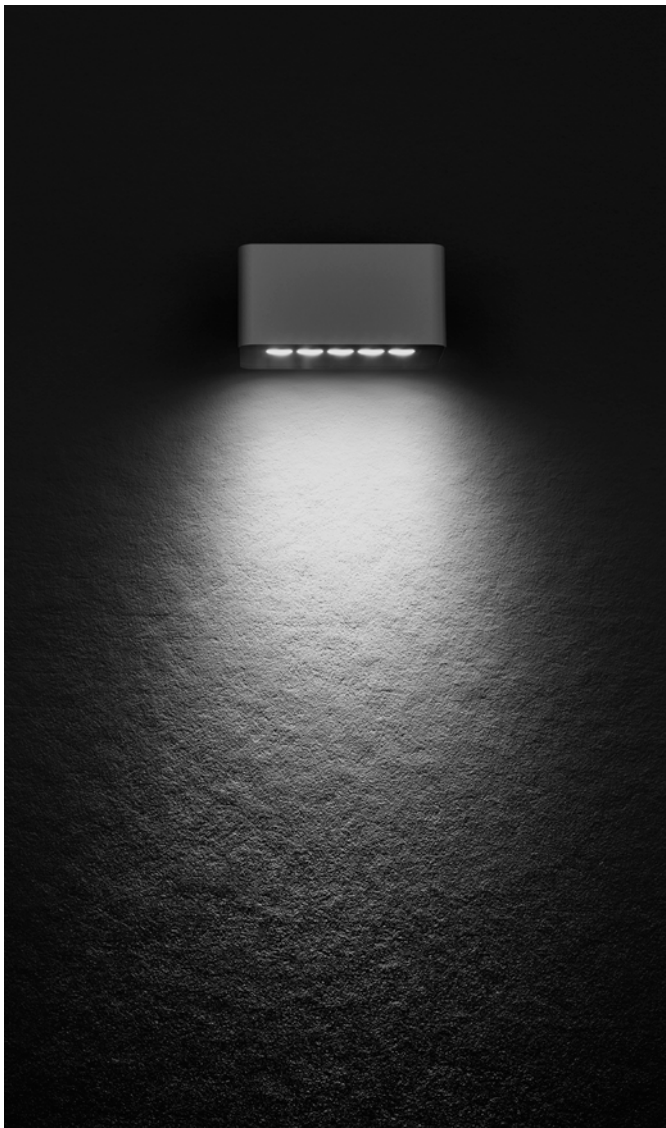

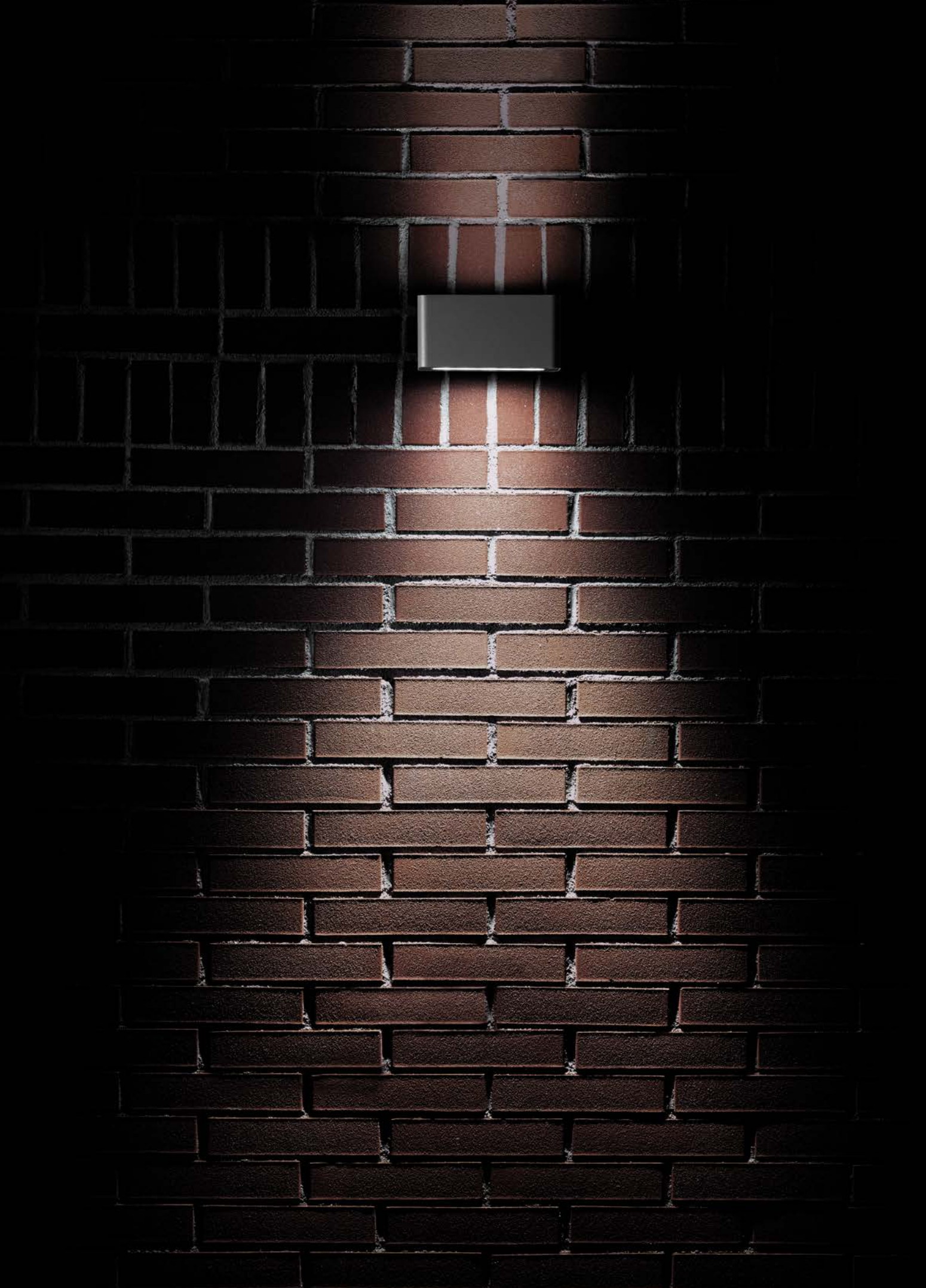



Tag

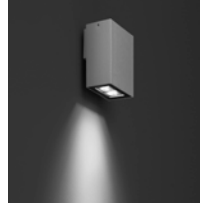
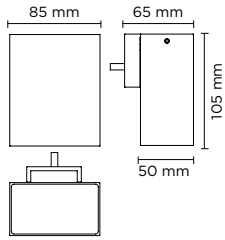

PRODUCT WEIGHT 1,00 kg



Code Example

402501 .30 .15 .01 .0

Tag Mini 01

Wall applique, to be mounted on an outdoor façade/wall, with one side light distribution. Luminaire body is made of extruded copper-free aluminum, secured with die-cast aluminum base, tempered safety glass, moulded silicone gasket and stainless steel screws. Built-in LED driver 220-240V 50-60Hz, with nr. 2 CREE XP-G2 LED. IP65 rating.

402501
4,5W

CCT	Beam Angle	lm	lm/w
.30 3000°K	.15 15°	280	62.22
	.55 55°	270	60.00
.40 4000°K	.15 15°	308	68.44
	.55 55°	292	64.88

Finish	Dimming
.01 RAL 9006	.0 ON/OFF
.02 RAL 7016	
.03 RAL 9005	

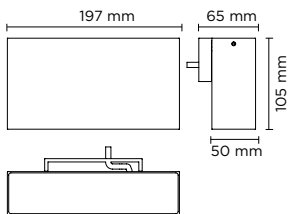

PRODUCT WEIGHT 1,50 kg

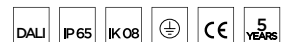

Code Example

402502 .30 .15 .01 .0

Tag Medium 01

Wall applique, to be mounted on an outdoor façade/wall, with one side light distribution. Luminaire body is made of extruded copper-free aluminum, secured with die-cast aluminum base, tempered safety glass, moulded silicone gasket and stainless steel screws. Built-in LED driver 220-240V 50-60Hz, with nr. 6 CREE XP-G2 LED. IP65 rating.

402502
8W

CCT	Beam Angle	lm	lm/w
.30 3000°K	.15 15°	840	105.00
	.55 55°	810	101.25
.40 4000°K	.15 15°	924	115.50
	.55 55°	876	109.50

Finish	Dimming
.01 RAL 9006	.0 ON/OFF
.02 RAL 7016	.D DALI
.03 RAL 9005	

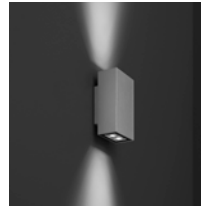
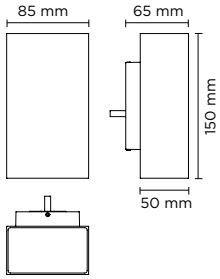

PRODUCT WEIGHT 1,20 kg



Code Example

402503, 30, 15, 01, 0

Tag Mini O2

Wall applique, to be mounted on an outdoor façade/wall, with two sides light distribution (up & down). Luminaire body is made of extruded copper-free aluminum, secured with die-cast aluminum base and aluminum fixing bracket, tempered safety glass, moulded silicone gasket and stainless steel screws. Built-in LED driver 220-240V 50-60Hz, with nr. 2 x 2 CREE XP-G2 LED. IP65 rating.

402503
7W

CCT	Beam Angle	lm	lm/w	Finish	Dimming
.30 3000°K	.15 15°	2 x 280	80.00	.01 RAL 9006	.0 ON/OFF
	.55 55°	2 x 270	77.14	.02 RAL 7016	
.40 4000°K	.15 15°	2 x 308	88.00	.03 RAL 9005	
	.55 55°	2 x 292	83.42		

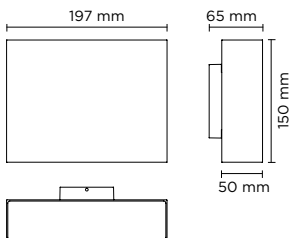

PRODUCT WEIGHT 2,00 kg



Code Example

402504, 30, 15, 01, 0

Tag Medium O2

Wall applique, to be mounted on an outdoor façade/wall, with two sides light distribution (up & down). Luminaire body is made of extruded copper-free aluminum, secured with die-cast aluminum base and aluminum fixing bracket, tempered safety glass, moulded silicone gasket and stainless steel screws. Built-in LED driver 220-240V 50-60Hz, with nr. 2 x 6 CREE XP-G2 LED. IP65 rating.

402504
15W

CCT	Beam Angle	lm	lm/w	Finish	Dimming
.30 3000°K	.15 15°	2 x 840	112.00	.01 RAL 9006	.0 ON/OFF
	.55 55°	2 x 810	108.00	.02 RAL 7016	.D DALI
.40 4000°K	.15 15°	2 x 924	123.20	.03 RAL 9005	
	.55 55°	2 x 876	116.80		



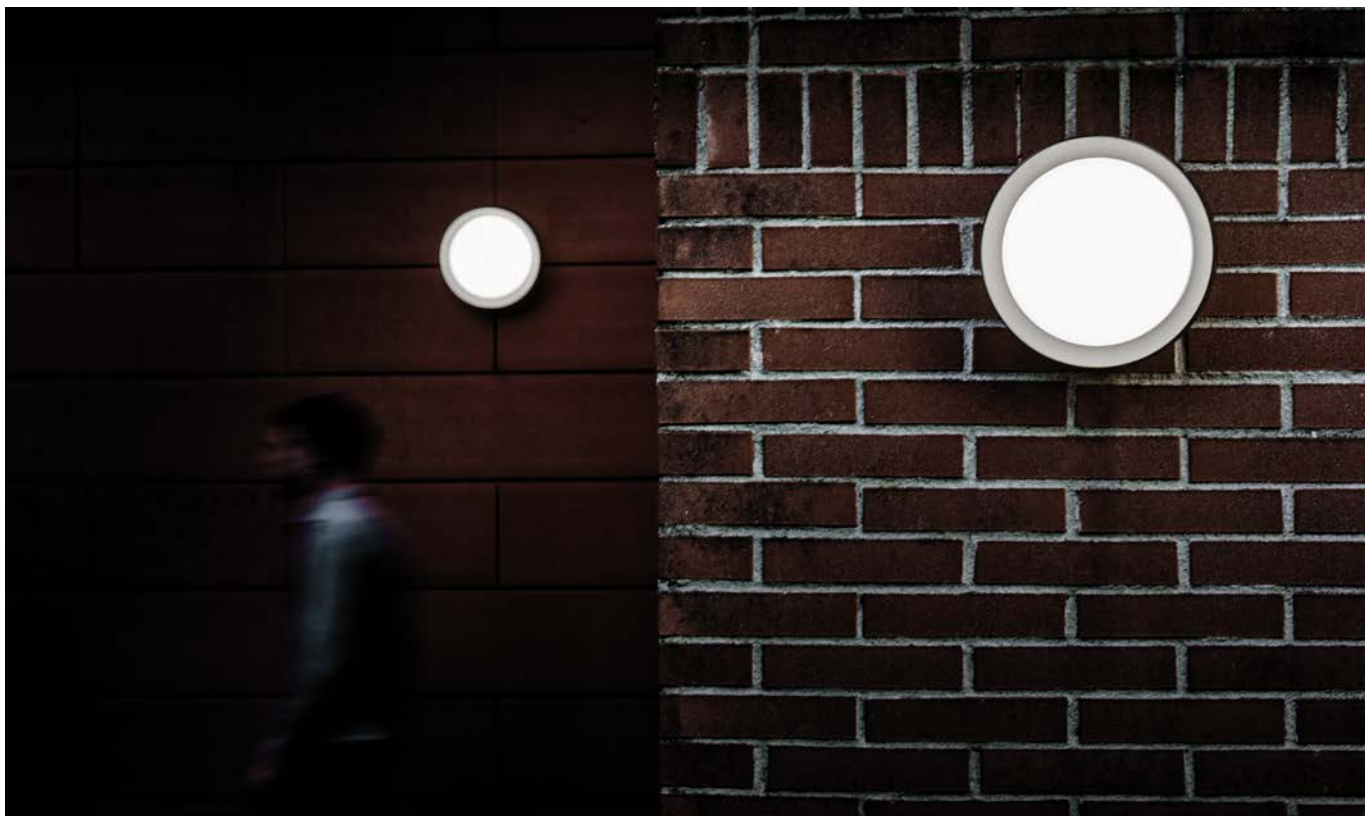

Frame

Nava + Arosio

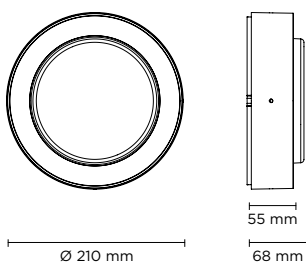

PRODUCT WEIGHT 3,20 kg

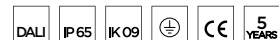

Code Example



402801.27.DF.01.0

Accessories p. 208

Frame Medium Round

Round diam. 210mm surface mounted luminaire for outdoor installation on a façade/wall. Phospho-chromatised and polyester powder coated die-cast copper-free aluminium body, acid-etched tempered glass diffuser white painted internally, moulded silicone gasket and stainless steel screws. Built-in LED driver 220-240V 50-60Hz, with 36 x mid-power SAMSUNG 2835 LED. IP65 rating.

402801
16W

CCT	Beam Angle	lm	lm/w	Finish	Dimming
.27 2700°K	.DF diffused	768	48.00	.01  RAL 9006	.0 ON/OFF
.30 3000°K	.DF diffused	808	50.50	.02  RAL 7016	.D DALI
.40 4000°K	.DF diffused	844	52.75	.03  RAL 9005	

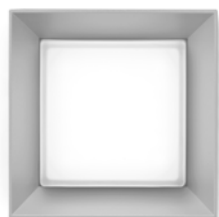
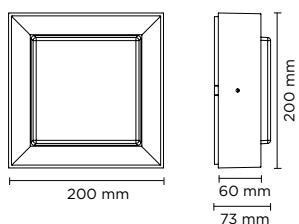

PRODUCT WEIGHT 3,50 kg



Code Example

402802.27.DF.01.0

Accessories p. 208

Frame Medium Square

Square 200x200mm surface mounted luminaire for outdoor installation on a façade/wall. Phospho-chromatised and polyester powder coated die-cast copper-free aluminium body, acid-etched tempered glass diffuser white painted internally, moulded silicone gasket and stainless steel screws. Built-in LED driver 220-240V 50-60Hz, with 36 x mid-power SAMSUNG 2835 LED. IP65 rating.

402802

16W

CCT	Beam Angle	lm	lm/w	Finish	Dimming
.27 2700°K	.DF diffused	768	48.00	.01 RAL 9006	.0 ON/OFF
.30 3000°K	.DF diffused	808	50.50	.02 RAL 7016	.D DALI
.40 4000°K	.DF diffused	844	52.75	.03 RAL 9005	

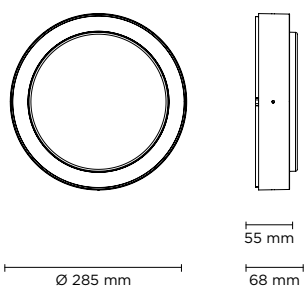

PRODUCT WEIGHT 4,20 kg

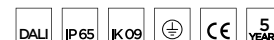

Code Example

402803.27.DF.01.0

Accessories p. 208

Frame Maxi Round

Round diam. 285mm surface mounted luminaire for outdoor installation on a façade/wall. Phospho-chromatised and polyester powder coated die-cast copper-free aluminium body, acid-etched tempered glass diffuser white painted internally, moulded silicone gasket and stainless steel screws. Built-in LED driver 220-240V 50-60Hz, with 48 x mid-power SAMSUNG 2835 LED. IP65 rating.

402803

20W

CCT	Beam Angle	lm	lm/w	Finish	Dimming
.27 2700°K	.DF diffused	960	48.00	.01 RAL 9006	.0 ON/OFF
.30 3000°K	.DF diffused	1.010	50.50	.02 RAL 7016	.D DALI
.40 4000°K	.DF diffused	1.055	52.75	.03 RAL 9005	

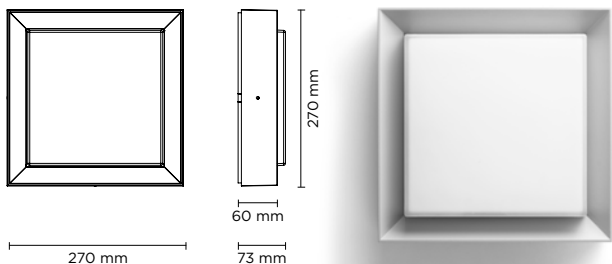

PRODUCT WEIGHT 4,50 kg

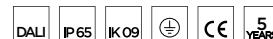



Code Example

402804 . 27 . DF . 01 . 0

Accessories p. 208

Frame Maxi Square

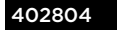
Square 270x270mm surface mounted luminaire for outdoor installation on a façade/wall. Phospho-chromatised and polyester powder coated die-cast copper-free aluminium body, acid-etched tempered glass diffuser white painted internally, moulded silicone gasket and stainless steel screws. Built-in LED driver 220-240V 50-60Hz, with 48 x mid-power SAMSUNG 2835 LED. IP65 rating.

	CCT	Beam Angle	lm	lm/w	Finish	Dimming
402804	.27 2700°K	.DF diffused	960	48.00	.01  RAL 9006	.0 ON/OFF
20W						.02  RAL 7016
	.30 3000°K	.DF diffused	1.010	50.50	.03  RAL 9005	
	.40 4000°K	.DF diffused	1.055	52.75		

ACCESSORIES NOT INCLUDED

Accessories to be ordered separately.

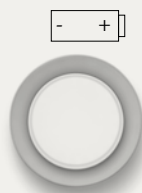

402803EM

EMERGENCY LIGHT

Optional version with 3h emergency.

Available for:

FRAME MAXI ROUND



402804EM

EMERGENCY LIGHT

Optional version with 3h emergency.

Available for:

FRAME MAXI SQUARE



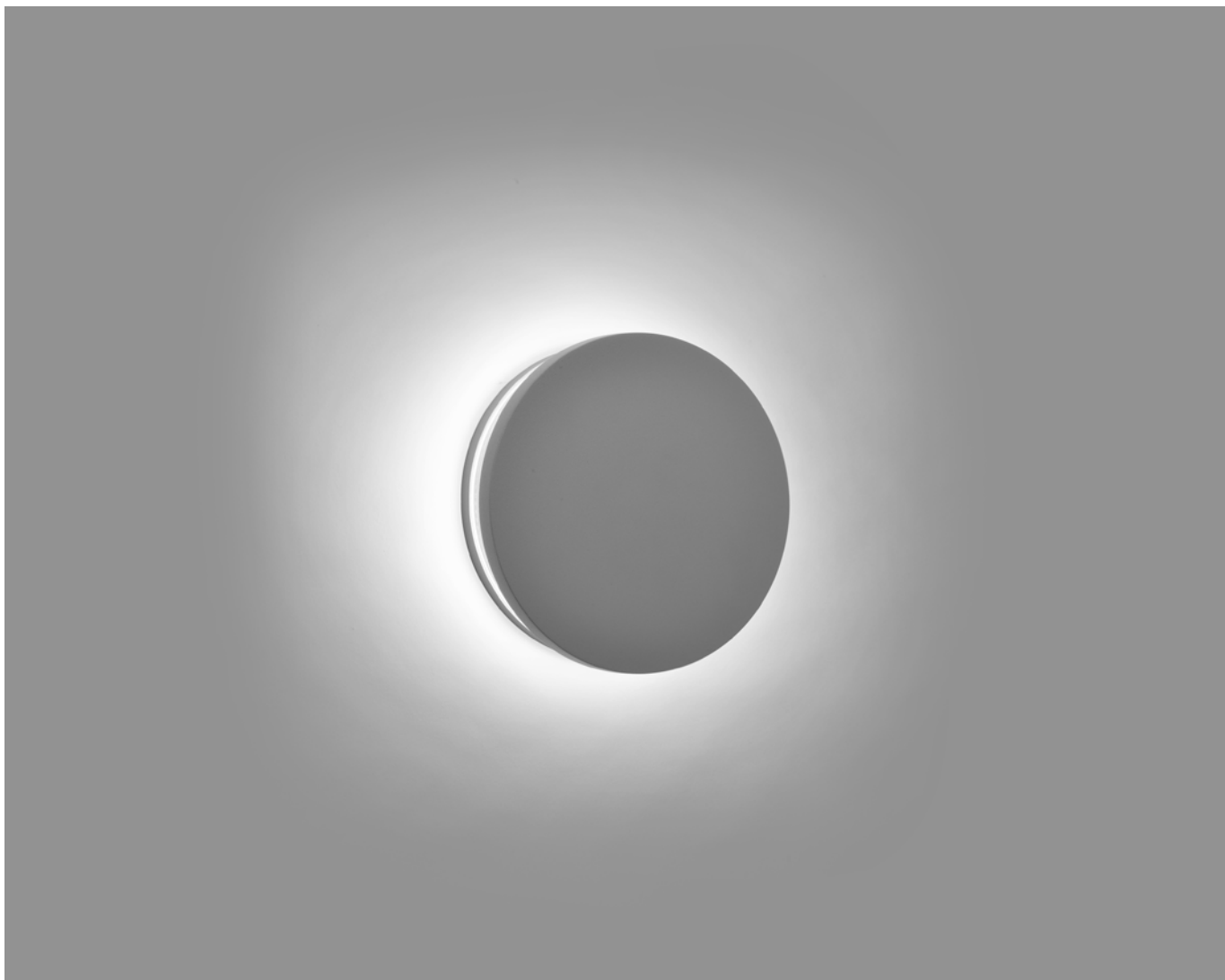

Eclipse

Paolo Villa

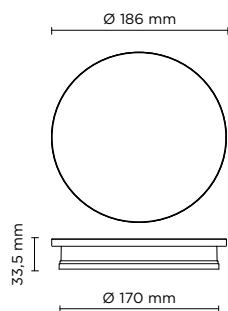

PRODUCT WEIGHT 1,00 kg



Code Example



401701 .30 .AL .01 .0

Eclipse Mini Round

Round wall surface-mounted luminaire creating a diffused and discrete light through the fixture perimeter on the wall. Fixture for outdoor installation on a wall. Phospho-chromatised and polyester powder coated die-cast copper-free aluminium body, frosted polycarbonate diffuser, moulded silicone gasket and stainless steel screws. Built-in LED driver 220-240V 50-60Hz, with low-power CREE LED. IP65 rating.

401701

9W

CCT*	Beam Angle	lm	lm/w	Finish	Dimming
.30 3000°K	.AL 360°	446	49.55	.01  RAL 9006	.0 ON/OFF
				.02  RAL 7016	
				.03  RAL 9005	

*Other light colors available on request: Neutral-white

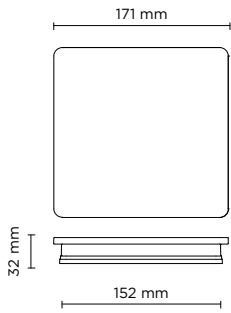

PRODUCT WEIGHT 1,00 kg



Code Example

401702, .30, AL, .01, .0

Accessories p. 13

401702

10W

Eclipse Mini Square

Square wall surface-mounted luminaire creating a diffused and discrete light through the fixture perimeter on the wall. Fixture for outdoor installation on a wall. Phospho-chromatised and polyester powder coated die-cast copper-free aluminium body, frosted polycarbonate diffuser, moulded silicone gasket and stainless steel screws. Built-in LED driver 220-240V 50-60Hz, with low-power CREE LED. IP65 rating.

CCT*	Beam Angle	lm	lm/w	Finish	Dimming
.30 3000°K	.AL 360°	474	47.40	.01 RAL 9006	.0 ON/OFF
				.02 RAL 7016	
				.03 RAL 9005	

*Other light colors available on request: Neutral-white

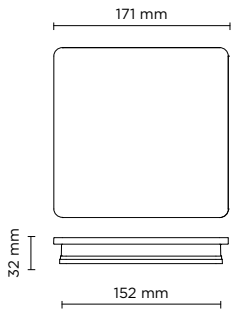

PRODUCT WEIGHT 1,00 kg



Code Example

401703, .30, .30, .01, .0

401703

4W

Eclipse Mini Square 01

Square wall surface-mounted luminaire creating a mono-directional wall-washer lighting effect on the wall. Fixture for outdoor installation on a wall. Phospho-chromatised and polyester powder coated die-cast copper-free aluminium body, frosted polycarbonate diffuser, moulded silicone gasket and stainless steel screws. Built-in LED driver 220-240V 50-60Hz, with 6 mid-power CREE XH-G LED. IP65 rating.

CCT*	Beam Angle	lm	lm/w	Finish	Dimming
.30 3000°K	.30 30°	350	87.50	.01 RAL 9006	.0 ON/OFF
				.02 RAL 7016	
				.03 RAL 9005	

*Other light colors available on request: Neutral-white

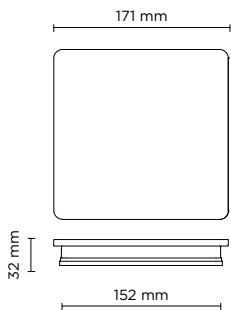

PRODUCT WEIGHT 1,00 kg



Code Example

401704, .30, AL, .01, .0

401704

8W

Eclipse Mini Square 02

Square wall surface-mounted luminaire creating a bi-directional (up&down) wall-washer lighting effect on the wall. Fixture for outdoor installation on a wall. Phospho-chromatised and polyester powder coated die-cast copper-free aluminium body, frosted polycarbonate diffuser, moulded silicone gasket and stainless steel screws. Built-in LED driver 220-240V 50-60Hz, with 2x6 mid-power CREE XH-G LED. IP65 rating.

CCT*	Beam Angle	lm	lm/w	Finish	Dimming
.30 3000°K	.30 2 x 30°	2 x 350	87.50	.01 RAL 9006	.0 ON/OFF
				.02 RAL 7016	
				.03 RAL 9005	

*Other light colors available on request: Neutral-white

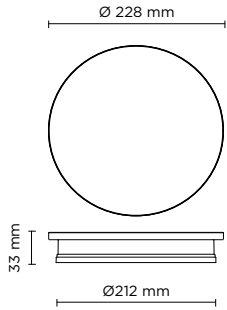

PRODUCT WEIGHT 1,50 kg



Code Example

401705.30.AL.01.0

Eclipse Medium Round

Round wall surface-mounted luminaire creating a diffused and discrete light through the fixture perimeter on the wall. Fixture for outdoor installation on a wall. Phospho-chromatised and polyester powder coated die-cast copper-free aluminium body, frosted polycarbonate diffuser, moulded silicone gasket and stainless steel screws. Built-in LED driver 220-240V 50-60Hz, with low-power CREE LED. IP65 rating.

401705
12W

CCT*	Beam Angle	lm	lm/w	Finish	Dimming
.30 3000°K	.AL 360°	556	46.33	.01 RAL 9006	.0 ON/OFF
				.02 RAL 7016	
				.03 RAL 9005	

*Other light colors available on request: Neutral-white

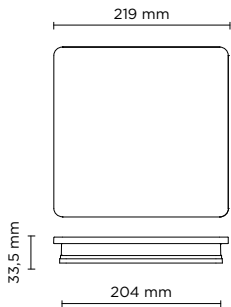

PRODUCT WEIGHT 1,50 kg



Code Example

401706.30.AL.01.0

Accessories p. 13

401706
14W

Eclipse Medium Square

Square wall surface-mounted luminaire creating a diffused and discrete light through the fixture perimeter on the wall. Fixture for outdoor installation on a wall. Phospho-chromatised and polyester powder coated die-cast copper-free aluminium body, frosted polycarbonate diffuser, moulded silicone gasket and stainless steel screws. Built-in LED driver 220-240V 50-60Hz, with low-power CREE LED. IP65 rating.

CCT*	Beam Angle	lm	lm/w	Finish	Dimming
.30 3000°K	.AL 360°	636	45.42	.01 RAL 9006	.0 ON/OFF
				.02 RAL 7016	
				.03 RAL 9005	

*Other light colors available on request: Neutral-white

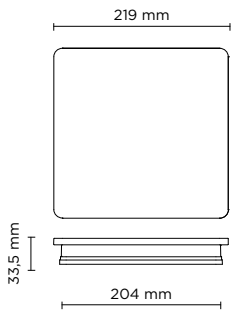

PRODUCT WEIGHT 1,50 kg



Eclipse Medium Square 01

Code Example

401707, .30, .30, .01, .0

Square wall surface-mounted luminaire creating a mono-directional wall-washer lighting effect on the wall. Fixture for outdoor installation on a wall. Phospho-chromatised and polyester powder coated die-cast copper-free aluminium body, frosted polycarbonate diffuser, moulded silicone gasket and stainless steel screws. Built-in LED driver 220-240V 50-60Hz, with 14 mid-power CREE XH-G LED. IP65 rating.

401707
10W

CCT*	Beam Angle	lm	lm/w	Finish	Dimming
.30 3000°K	.30 30°	650	65.00	.01 RAL 9006	.0 ON/OFF
				.02 RAL 7016	
				.03 RAL 9005	

*Other light colors available on request: Neutral-white

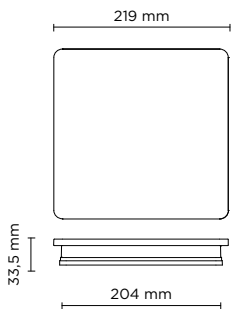

PRODUCT WEIGHT 1,50 kg



Eclipse Medium Square 02

Code Example

401708, .30, .30, .01, .0

Square wall surface-mounted luminaire creating a bi-directional (up&down) wall-washer lighting effect on the wall. Fixture for outdoor installation on a wall. Phospho-chromatised and polyester powder coated die-cast copper-free aluminium body, frosted polycarbonate diffuser, moulded silicone gasket and stainless steel screws. Built-in LED driver 220-240V 50-60Hz, with 2x14 mid-power CREE XH-G LED. IP65 rating.

401708
19W

CCT*	Beam Angle	lm	lm/w	Finish	Dimming
.30 3000°K	.30 2 x 30°	2 x 650	68.42	.01 RAL 9006	.0 ON/OFF
				.02 RAL 7016	
				.03 RAL 9005	

*Other light colors available on request: Neutral-white

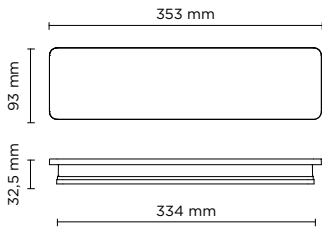

PRODUCT WEIGHT 1,50 kg



Eclipse Linear 350

Code Example

401709 .30 .AL .01 .0

Rectangular wall surface-mounted luminaire creating a diffused and discrete light through the fixture perimeter on the wall. Fixture for outdoor installation on a wall. Phospho-chromatised and polyester powder coated die-cast copper-free aluminium body, frosted polycarbonate diffuser, moulded silicone gasket and stainless steel screws. Built-in LED driver 220-240V 50-60Hz, with low-power CREE LED. IP65 rating.

401709

14W

CCT*	Beam Angle	lm	lm/w	Finish	Dimming
.30 3000°K	.AL 360°	584	41.71	.01 RAL 9006	.0 ON/OFF
				.02 RAL 7016	
				.03 RAL 9005	

*Other light colors available on request: Neutral-white

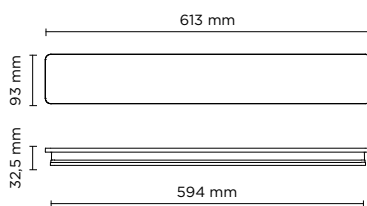

PRODUCT WEIGHT 2,00 kg



Eclipse Linear 600

Code Example

401710 .30 .AL .01 .0

401710

24W

Rectangular wall surface-mounted luminaire creating a diffused and discrete light through the fixture perimeter on the wall. Fixture for outdoor installation on a wall. Phospho-chromatised and polyester powder coated die-cast copper-free aluminium body, frosted polycarbonate diffuser, moulded silicone gasket and stainless steel screws. Built-in LED driver 220-240V 50-60Hz, with low-power CREE LED. IP65 rating.

CCT*	Beam Angle	lm	lm/w	Finish	Dimming
.30 3000°K	.AL 360°	781	32.54	.01 RAL 9006	.0 ON/OFF
				.02 RAL 7016	
				.03 RAL 9005	

*Other light colors available on request: Neutral-white

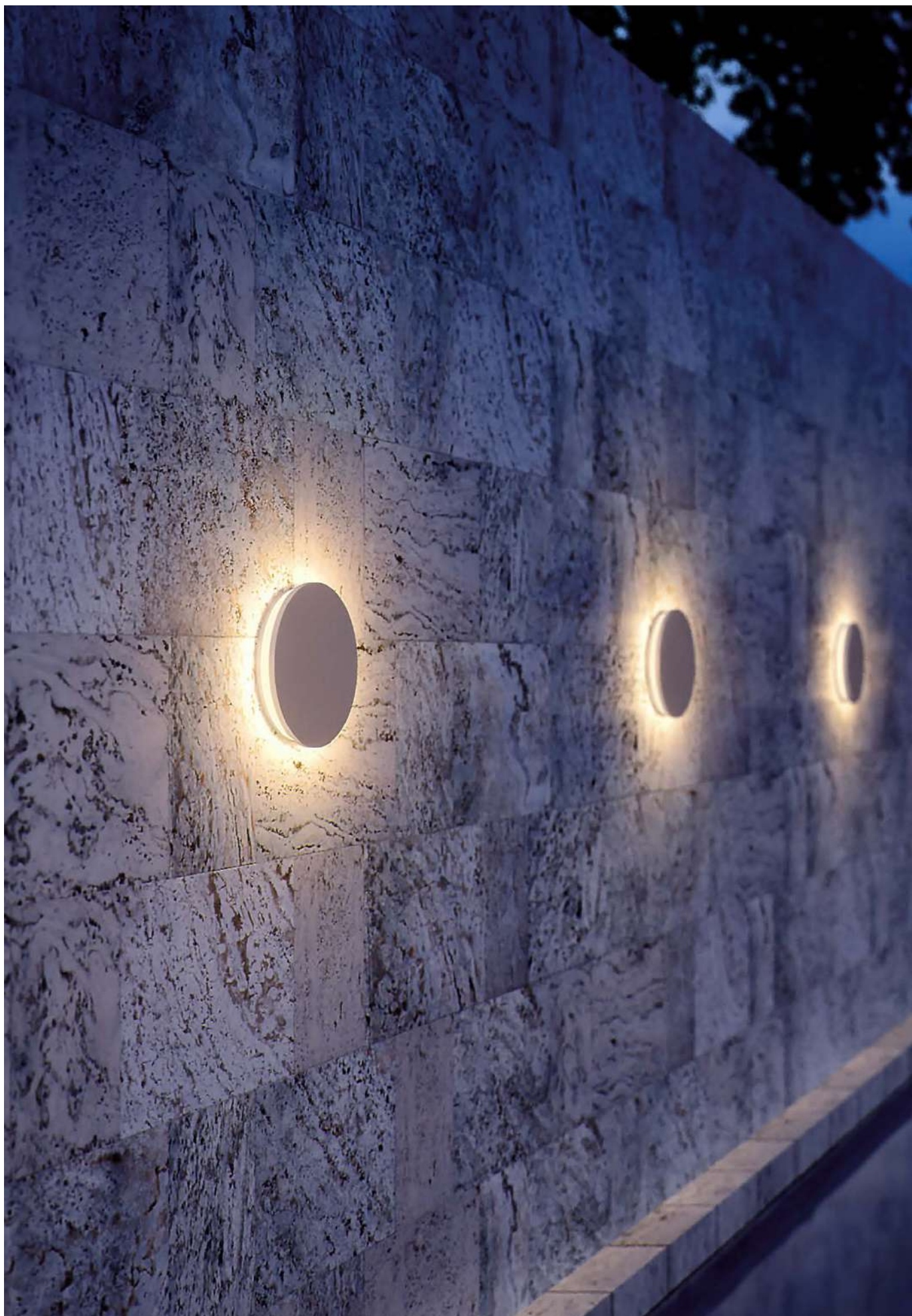



Surf

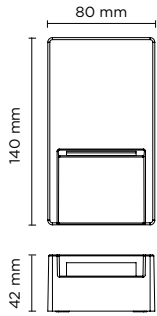

PRODUCT WEIGHT 0,60 kg



Code Example

401607.27.FW.01.0

Surf Mini Rectangular

Rectangular wall surface-mounted luminaire for outdoor installation on a wall, no recess needed.

Phospho-chromatised and polyester powder coated die-cast copper-free aluminium body, tempered safety glass, moulded silicone gasket and stainless steel screws. Built-in LED driver 220-240V 50-60Hz, with 6 mid-power CREE XH-G LED. IP65 rating.

401607

4W

CCT	Beam Angle	lm	lm/w	Finish	Dimming
.27 2700°K	.FW floor washer 180°	333	83.25	.01 RAL 9006	.0 ON/OFF
.30 3000°K	.FW floor washer 180°	350	87.50	.02 RAL 7016	
.40 4000°K	.FW floor washer 180°	368	92.00	.03 RAL 9005	

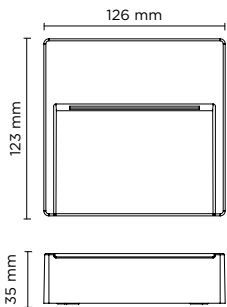

PRODUCT WEIGHT 0,60 kg



Code Example

401602.27.FW.01.0

Surf Mini Square

Square wall surface-mounted luminaire for outdoor installation on a wall, no recess needed. Phospho-chromatised and polyester powder coated die-cast copper-free aluminium body, tempered safety glass, moulded silicone gasket and stainless steel screws. Built-in LED driver 220-240V 50-60Hz, with 6 mid-power CREE XH-G LED. IP65 rating.

401602

4W

CCT	Beam Angle	lm	lm/w	Finish	Dimming
.27 2700°K	.FW floor washer 180°	333	83.25	.01 RAL 9006	.0 ON/OFF
.30 3000°K	.FW floor washer 180°	350	87.50	.02 RAL 7016	
.40 4000°K	.FW floor washer 180°	368	92.00	.03 RAL 9005	

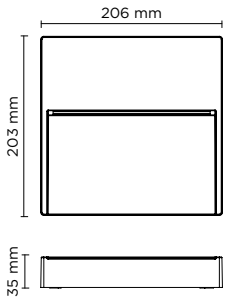

PRODUCT WEIGHT 1,40 kg



Code Example

401604, .27, FW, .01, 0

Surf Medium Square

Square wall surface-mounted luminaire for outdoor installation on a wall, no recess needed. Phospho-chromatised and polyester powder coated die-cast copper-free aluminium body, tempered safety glass, moulded silicone gasket and stainless steel screws. Built-in LED driver 220-240V 50-60Hz, with 14 mid-power CREE XH-G LED. IP65 rating.

401604

8W

CCT	Beam Angle	lm	lm/w	Finish	Dimming
.27 2700°K	.FW floor washer 180°	618	77.25	.01 RAL 9006	.0 ON/OFF
.30 3000°K	.FW floor washer 180°	650	81.25	.02 RAL 7016	.D DALI
.40 4000°K	.FW floor washer 180°	683	85.38	.03 RAL 9005	

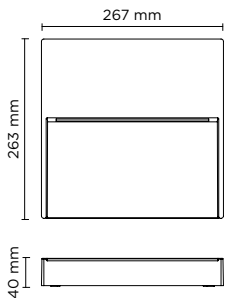

PRODUCT WEIGHT 2,00 kg



Code Example

401606, .27, FW, .01, 0

Surf Maxi Square

Square wall surface-mounted luminaire for outdoor installation on a wall, no recess needed. Phospho-chromatised and polyester powder coated die-cast copper-free aluminium body, tempered safety glass, moulded silicone gasket and stainless steel screws. Built-in LED driver 220-240V 50-60Hz, with 21 mid-power CREE XH-G LED. IP65 rating.

401606

14W

CCT	Beam Angle	lm	lm/w	Finish	Dimming
.27 2700°K	.FW floor washer 180°	950	67.86	.01 RAL 9006	.0 ON/OFF
.30 3000°K	.FW floor washer 180°	1.000	71.43	.02 RAL 7016	.D DALI
.40 4000°K	.FW floor washer 180°	1.050	75.00	.03 RAL 9005	

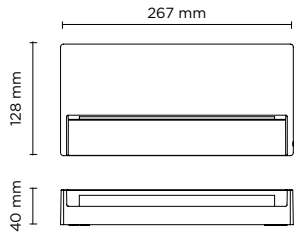

PRODUCT WEIGHT 1,70 kg



Code Example

401608 . 27 . FW . 01 . 0

Surf Maxi Rectangular

Rectangular wall surface-mounted luminaire for outdoor installation on a wall, no recess needed. Phospho-chromatised and polyester powder coated die-cast copper-free aluminium body, tempered safety glass, moulded silicone gasket and stainless steel screws. Built-in LED driver 220-240V 50-60Hz, with 21 mid-power CREE XH-G LED. IP65 rating.

401608

14W

CCT	Beam Angle	lm	lm/w	Finish	Dimming
.27 2700°K	.FW floor washer 180°	950	67.86	.01 RAL 9006	.0 ON/OFF
.30 3000°K	.FW floor washer 180°	1.000	71.43	.02 RAL 7016	
.40 4000°K	.FW floor washer 180°	1.050	75.00	.03 RAL 9005	

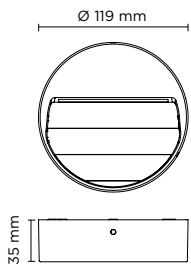

PRODUCT WEIGHT 0,60 kg



Code Example

401601 . 27 . FW . 01 . 0

Surf Mini Round

Round wall surface-mounted luminaire for outdoor installation on a wall, no recess needed. Phospho-chromatised and polyester powder coated die-cast copper-free aluminium body, tempered safety glass, moulded silicone gasket and stainless steel screws. Built-in LED driver 220-240V 50-60Hz, with 6 mid-power CREE XH-G LED. IP65 rating.

401601

4W

CCT	Beam Angle	lm	lm/w	Finish	Dimming
.27 2700°K	.FW floor washer 180°	333	83.25	.01 RAL 9006	.0 ON/OFF
.30 3000°K	.FW floor washer 180°	350	87.50	.02 RAL 7016	
.40 4000°K	.FW floor washer 180°	368	92.00	.03 RAL 9005	

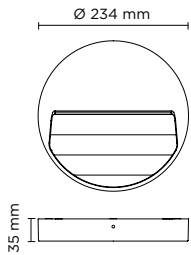

PRODUCT WEIGHT 1,40 kg



Code Example

401603.27.FW.01.0

Surf Medium Round

Round wall surface-mounted luminaire for outdoor installation on a wall, no recess needed. Phospho-chromatised and polyester powder coated die-cast copper-free aluminium body, tempered safety glass, moulded silicone gasket and stainless steel screws. Built-in LED driver 220-240V 50-60Hz, with 14 mid-power CREE XH-G LED. IP65 rating.

401603

8W

CCT	Beam Angle	Im	Im/w	Finish	Dimming
.27 2700°K	.FW floor washer 180°	618	77.25	.01 RAL 9006	.0 ON/OFF
.30 3000°K	.FW floor washer 180°	650	81.25	.02 RAL 7016	
.40 4000°K	.FW floor washer 180°	683	85.38	.03 RAL 9005	

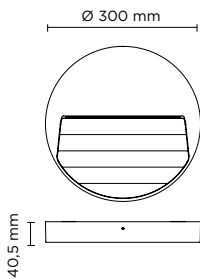

PRODUCT WEIGHT 2,0 kg



Code Example

401605.27.FW.01.0

Surf Maxi Round

Round wall surface-mounted luminaire for outdoor installation on a wall, no recess needed. Phospho-chromatised and polyester powder coated die-cast copper-free aluminium body, tempered safety glass, moulded silicone gasket and stainless steel screws. Built-in LED driver 220-240V 50-60Hz, with 21 mid-power CREE XH-G LED. IP65 rating.

401605

14W

CCT	Beam Angle	Im	Im/w	Finish	Dimming
.27 2700°K	.FW floor washer 180°	950	67.86	.01 RAL 9006	.0 ON/OFF
.30 3000°K	.FW floor washer 180°	1.000	71.43	.02 RAL 7016	
.40 4000°K	.FW floor washer 180°	1.050	75.00	.03 RAL 9005	





Hydrocove

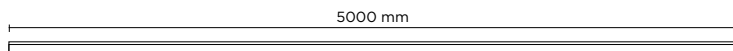

Hydrocove x36 5000

Code Example

402101.30.DF.OP.0

Accessories p. 223

Cove light 5.000 mm length, 5 mm x 10 mm section, fully encapsulated flexible LED strip for linear lighting outdoor and indoor; LED circuit completely encapsulated with UV and high-resistant polyurethane sheath, with transparent finish, homogeneous light emission. LED brand Nichia 757. 24V DC remote driver needed. IP68 rated.

402101
9W

CCT	Beam Angle	lm	lm/w	Finish	Dimming
.30 3000°K	.DF diffused	510/meter	56.66	.OP <input type="checkbox"/> transparent	.0 ON/OFF

Remote Driver Selection

Brand	Manufacturer code	Type	Watt	IP Rate	Number of fixtures
Meanwell	LPV-60-24	constant voltage 24V DC	60W	IP67	1

HYDROCOVE - SIDE SECTION

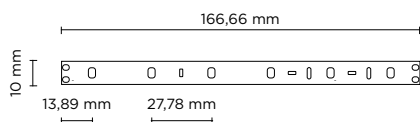
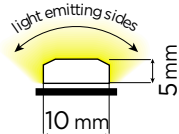

5000 mm



Hydrocove x70 5000

Code Example

402102 .30 .DF .OP .0

Accessories p. 223

Cove light 5.000 mm length, 5 mm x 10 mm section, fully encapsulated flexible LED strip for linear lighting outdoor and indoor; LED circuit completely encapsulated with UV and high-resistant polyurethane sheath, with transparent finish, homogeneous light emission. LED brand Nichia 757. 24V DC remote driver needed. IP68 rated.

402102

18W

CCT	Beam Angle	lm	lm/w	Finish	Dimming
.30 3000°K	.DF diffused	1500/meter	83.33	.OP <input type="checkbox"/> transparent	.0 ON/OFF

Remote Driver Selection

Brand	Manufacturer code	Type	Watt	IP Rate	Number of fixtures
Meanwell	LPV-60-24	constant voltage 24V DC	100W	IP67	1

HYDROCOVE - SIDE SECTION

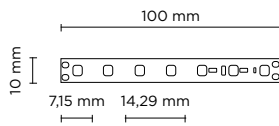
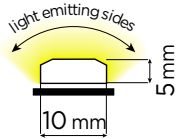

ACCESSORIES NOT INCLUDED

Accessories to be ordered separately.



AC039

ALUMINUM LINEAR PROFILE FOR HYDROCOVE RANGE

1.000 mm Linear profile for Hydrocove, realized in anodized aluminum, to secure with screws. Ideal for straight installation on a wall or ceiling.



AC054

SQUARE END CAP

Initial cable to connect the driver to first luminaire of an in-line installation of multiple luminaires, all connected to one driver. Kit contains two leader cables, one with male connector and one with female connector, to allow start the installation from both sides.

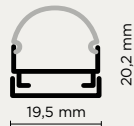

AC040

ROUND COVER - DIFFUSER

Round shape opal diffuser in polycarbonate, to be used with aluminum profile.

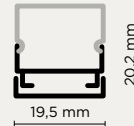

AC042

SQUARE COVER - DIFFUSER

Square shape opal diffuser in polycarbonate, to be used with aluminum profile.

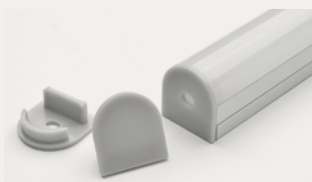

AC041

ROUND END CAP

Plastic end cap to close aluminum profile + round diffuser.

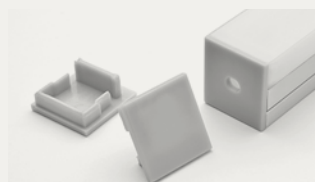

AC043

SQUARE END CAP

Plastic end cap to close aluminum profile + square diffuser.

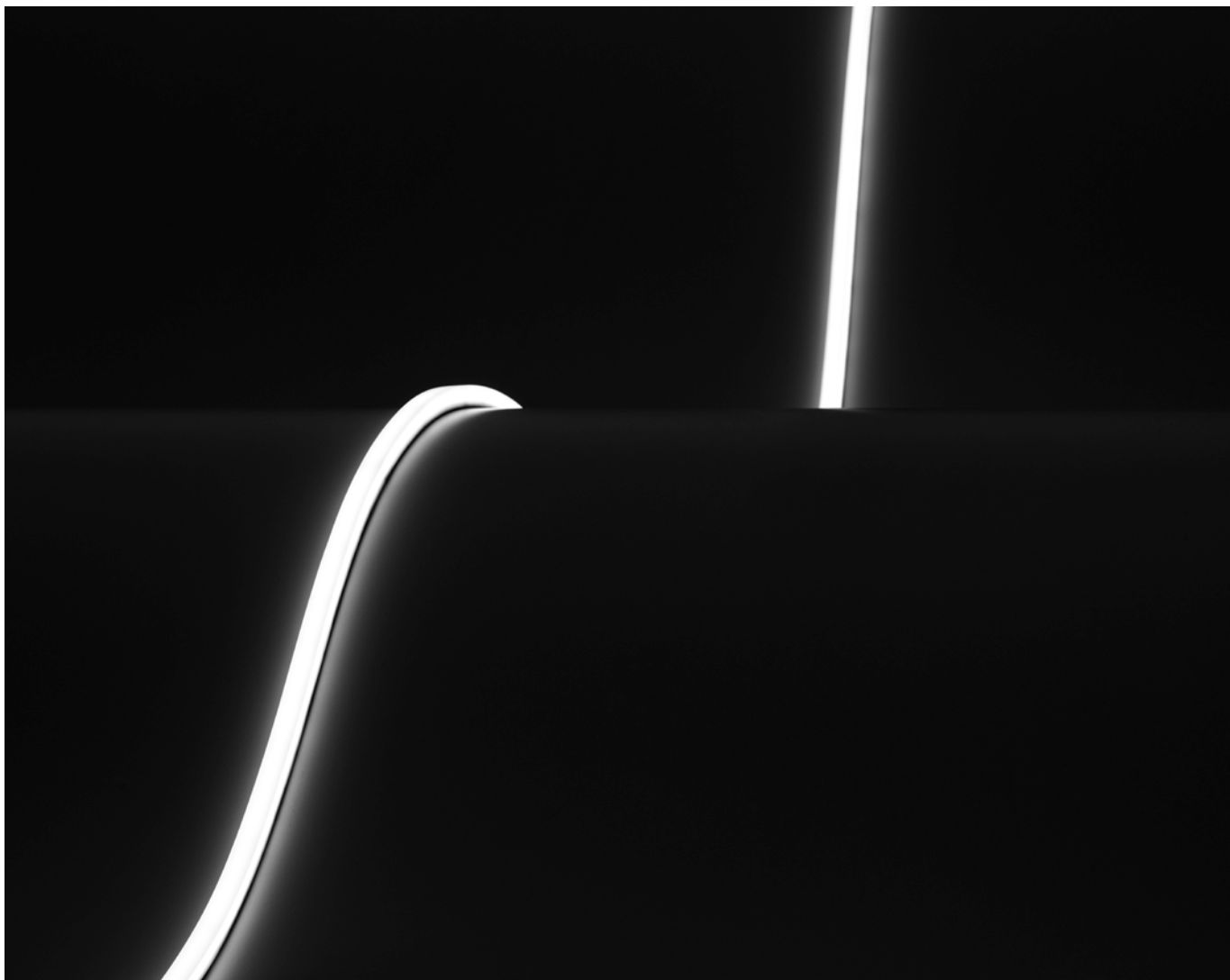

Hydroflex

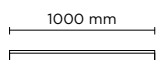

Code Example

401801 .30 .DF .OP .0

Accessories p. 228



Hydroflex Mini 1000

1.000 mm length, 10mm x 10mm section, opal encapsulated flexible LED strip for linear lighting (straight or bended) outdoor and indoor wall-recessed installation; surface mounted version through installation accessories to be ordered separately. LED circuit completely encapsulated with UV and high-temperatures resistant Polyurethane sheath, with white (outside) and milky finish (over light emission), dot free and homogeneous light emission surface. Double power cable with male/female connectors included, suitable for in-line installation. Cuttable every 50 mm. Remote driver 24V DC needed. With low-power SMD3014 Lumileds LED. IP68 rating.

CCT	Beam Angle	lm	lm/w	Finish	Dimming
401801 10W .30	3000°K .DF diffused	750	75.00	.OP <input type="checkbox"/> Milky	.0 ON/OFF

Remote Driver Selection

Brand	Manufacturer code	Type	Watt	IP Rate	Number of fixtures
Meanwell	LPV-20-24	constant voltage 24V DC	20W	IP67	1
Meanwell	LPV-35-24	constant voltage 24V DC	35W	IP67	min 1 - max 2
Meanwell	LPV-60-24	constant voltage 24V DC	60W	IP67	min 1 - max 5
Meanwell	LPV-100-24	constant voltage 24V DC	100W	IP67	min 1 - max 9

3000 mm



Hydroflex Mini 3000

Code Example

401802_30_DF.OP_0

Accessories p. 228

3.000 mm length, 10mm x 10mm section, opal encapsulated flexible LED strip for linear lighting (straight or bended) outdoor and indoor wall-recessed installation; surface mounted version through installation accessories to be ordered separately. LED circuit completely encapsulated with UV and high-temperatures resistant Polyurethane sheath, with white (outside) and milky finish (over light emission), dot free and homogeneous light emission surface. Double power cable with male/female connectors included, suitable for in-line installation. Cuttable every 50 mm. Remote driver 24V DC needed. With low-power SMD3014 Lumileds LED. IP68 rating.

401802
30W

CCT	Beam Angle	lm	lm/w	Finish	Dimming
.30 3000°K	.DF diffused	2.250	75.00	.OP <input type="checkbox"/> Milky	.0 ON/OFF

Remote Driver Selection

Brand	Manufacturer code	Type	Watt	IP Rate	Number of fixtures
Meanwell	LPV-35-24	constant voltage 24V DC	35W	IP67	1
Meanwell	LPV-100-24	constant voltage 24V DC	100W	IP67	min 1 - max 3

5000 mm



Hydroflex Mini 5000

Code Example

401803_30_DF.OP_0

Accessories p. 228

5.000 mm length, 10mm x 10mm section, opal encapsulated flexible LED strip for linear lighting (straight or bended) outdoor and indoor wall-recessed installation; surface mounted version through installation accessories to be ordered separately. LED circuit completely encapsulated with UV and high-temperatures resistant Polyurethane sheath, with white (outside) and milky finish (over light emission), dot free and homogeneous light emission surface. Double power cable with male/female connectors included, suitable for in-line installation. Cuttable every 50 mm. Remote driver 24V DC needed. With low-power SMD3014 Lumileds LED. IP68 rating.

401803
50W

CCT	Beam Angle	lm	lm/w	Finish	Dimming
.30 3000°K	.DF diffused	3.750	75.00	.OP <input type="checkbox"/> Milky	.0 ON/OFF

Remote Driver Selection

Brand	Manufacturer code	Type	Watt	IP Rate	Number of fixtures
Meanwell	LPV-100-24	constant voltage 24V DC	100W	IP67	1

HYDROFLEX MINI - SIDE SECTION

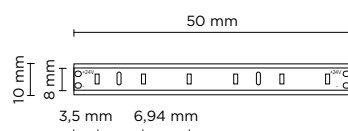
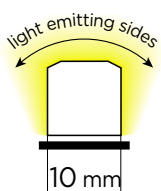

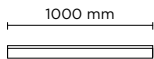

Hydroflex Side 1000

Code Example

401804.30.DF.OP.O

Accessories p. 228

1.000 mm length, 20mm x 12mm section, opal encapsulated flexible LED strip for linear lighting (straight or bended) outdoor and indoor wall-recessed installation; surface mounted version through installation accessories to be ordered separately. LED circuit completely encapsulated with UV and high-temperatures resistant Polyurethane sheath, with white (outside) and milky finish (over light emission), dot free and homogeneous light emission surface. Double power cable with male/female connectors included, suitable for in-line installation. Cuttable each 50 mm. Remote driver 24V DC needed. With low-power SMD3014 Lumileds LED. IP68 rating.

CCT	Beam Angle	lm	lm/w	Finish	Dimming	
401804 10W	.30 3000°K	.DF diffused	750	75.00	.OP <input type="checkbox"/> Milky	.0 ON/OFF

Remote Driver Selection

Brand	Manufacturer code	Type	Watt	IP Rate	Number of fixtures
Meanwell	LPV-20-24	constant voltage 24V DC	20W	IP67	1
Meanwell	LPV-35-24	constant voltage 24V DC	35W	IP67	min 1 - max 2
Meanwell	LPV-60-24	constant voltage 24V DC	60W	IP67	min 1 - max 5
Meanwell	LPV-100-24	constant voltage 24V DC	100W	IP67	min 1 - max 9

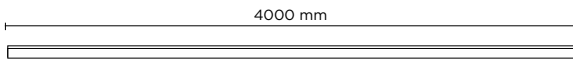

Hydroflex Side 4000

Code Example

401805.30.DF.O1.O

Accessories p. 228

4.000 mm length, 20mm x 12mm section, opal encapsulated flexible LED strip for linear lighting (straight or bended) outdoor and indoor wall-recessed installation; surface mounted version through installation accessories to be ordered separately. LED circuit completely encapsulated with UV and high-temperatures resistant Polyurethane sheath, with white (outside) and milky finish (over light emission), dot free and homogeneous light emission surface. Double power cable with male/female connectors included, suitable for in-line installation. Cuttable each 50 mm. Remote driver 24V DC needed. With low-power SMD3014 Lumileds LED. IP68 rating.

CCT	Beam Angle	lm	lm/w	Finish	Dimming	
401805 40W	.30 3000°K	.DF diffused	3.000	75.00	.01 <input type="checkbox"/> Milky	.0 ON/OFF

Remote Driver Selection

Brand	Manufacturer code	Type	Watt	IP Rate	Number of fixtures
Meanwell	LPV-60-24	constant voltage 24V DC	60W	IP67	1
Meanwell	LPV-100-24	constant voltage 24V DC	100W	IP67	min 1 - max 2

HYDROFLEX SIDE - SIDE SECTION

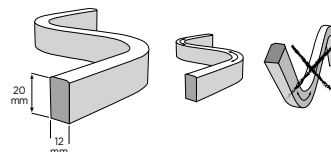
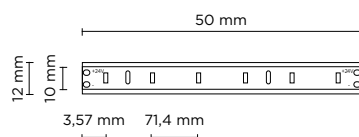
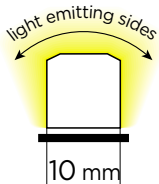

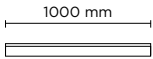

Hydroflex Top 1000

Code Example

401806.30.DF.OP.0

Accessories p. 228

1.000 mm length, 16mm x 15 mm section, opal encapsulated flexible LED strip for linear lighting (straight or bended) outdoor and indoor wall-recessed installation; surface mounted version through installation accessories to be ordered separately. LED circuit completely encapsulated with UV and high-temperatures resistant Polyurethane sheath, with white (outside) and milky finish (over light emission), dot free and homogeneous light emission surface. Double power cable with male/female connectors included, suitable for in-line installation. Cutable each 50 mm. Remote driver 24V DC needed. With low-power SMD3014 Lumileds LED. IP68 rating.

401806	CCT	Beam Angle	lm	lm/w	Finish	Dimming
	.30 3000°K	.DF diffused	750	75.00	.OP <input type="checkbox"/> Milky	.0 ON/OFF
10W						

Remote Driver Selection

Brand	Manufacturer code	Type	Watt	IP Rate	Number of fixtures
Meanwell	LPV-20-24	constant voltage 24V DC	20W	IP67	1
Meanwell	LPV-35-24	constant voltage 24V DC	35W	IP67	min 1 - max 2
Meanwell	LPV-60-24	constant voltage 24V DC	60W	IP67	min 1 - max 5
Meanwell	LPV-100-24	constant voltage 24V DC	100W	IP67	min 1 - max 9

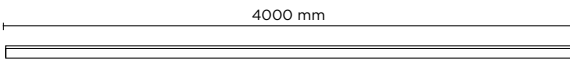

Hydroflex Top 4000

Code Example

401807.30.DF.OP.0

Accessories p. 228

4.000 mm length, 16mm x 15 mm section, opal encapsulated flexible LED strip for linear lighting (straight or bended) outdoor and indoor wall-recessed installation; surface mounted version through installation accessories to be ordered separately. LED circuit completely encapsulated with UV and high-temperatures resistant Polyurethane sheath, with white (outside) and milky finish (over light emission), dot free and homogeneous light emission surface. Double power cable with male/female connectors included, suitable for in-line installation. Cutable each 50 mm. Remote driver 24V DC needed. With low-power SMD3014 Lumileds LED. IP68 rating.

401807	CCT	Beam Angle	lm	lm/w	Finish	Dimming
	.30 3000°K	.DF diffused	3.000	75.00	.OP <input type="checkbox"/> Milky	.0 ON/OFF
40W						

Remote Driver Selection

Brand	Manufacturer code	Type	Watt	IP Rate	Number of fixtures
Meanwell	LPV-60-24	constant voltage 24V DC	60W	IP67	1
Meanwell	LPV-100-24	constant voltage 24V DC	100W	IP67	min 1 - max 2

HYDROFLEX TOP - SIDE SECTION

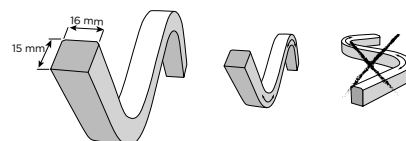
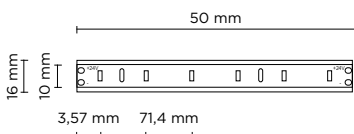
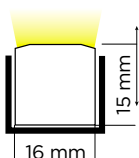

ACCESSORIES NOT INCLUDED

Accessories to be ordered separately.

MOUNTING CLIP

Mounting clip realized in Stainless steel, clip to be applied every 40 cm, to secure with screws. Ideal for bended installation on a wall or ceiling. Available for

AC028

HYDROFLEX MINI ITEMS

AC031

HYDROFLEX SIDE ITEMS

AC034

HYDROFLEX TOP ITEMS



ALUMINUM LINEAR PROFILE

1.000 mm Linear profile realized in Anodized aluminum. Available for

AC029

HYDROFLEX MINI ITEMS

AC032

HYDROFLEX SIDE ITEMS

AC035

HYDROFLEX TOP ITEMS

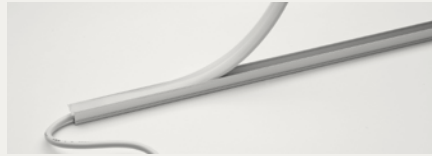

END CAP

End cap realized in Polyurethane, to be applied at the end of the line, after Hydroflex cut. Available for:

AC030

HYDROFLEX MINI ITEMS

AC033

HYDROFLEX SIDE ITEMS

AC036

HYDROFLEX TOP ITEMS

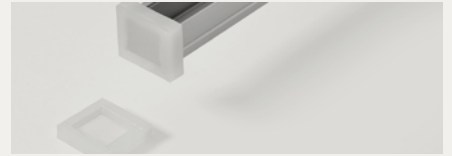

CURVED STAINLESS STEEL

Curved profile for Hydroflex Side realized in stainless steel AISI 304, to secure with screws. Ideal for curved installation.

Available for

AC059

FOR HYDROFLEX MINI ITEMS



AC060

FOR HYDROFLEX SIDE



AC061

FOR HYDROFLEX TOP



LEADER CABLE

Initial cable to connect the driver to first luminaire of an in-line installation of multiple luminaires, all connected to one driver. Kit contains two leader cables, one with male connector and one with female connector, to allow start the installation from both sides. Available for

AC054

HYDROFLEX MINI

HYDROFLEX SIDE

HYDROFLEX TOP



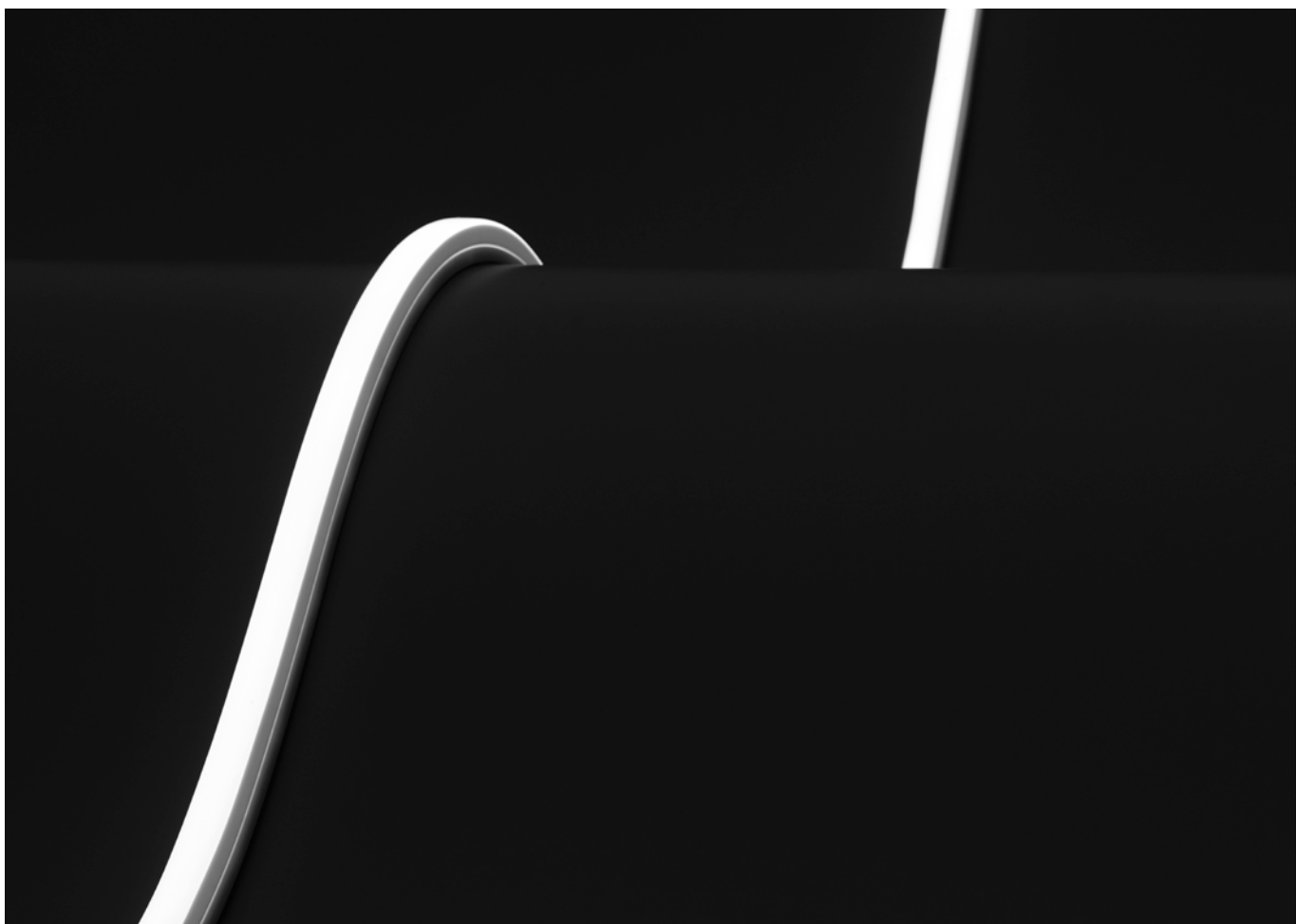
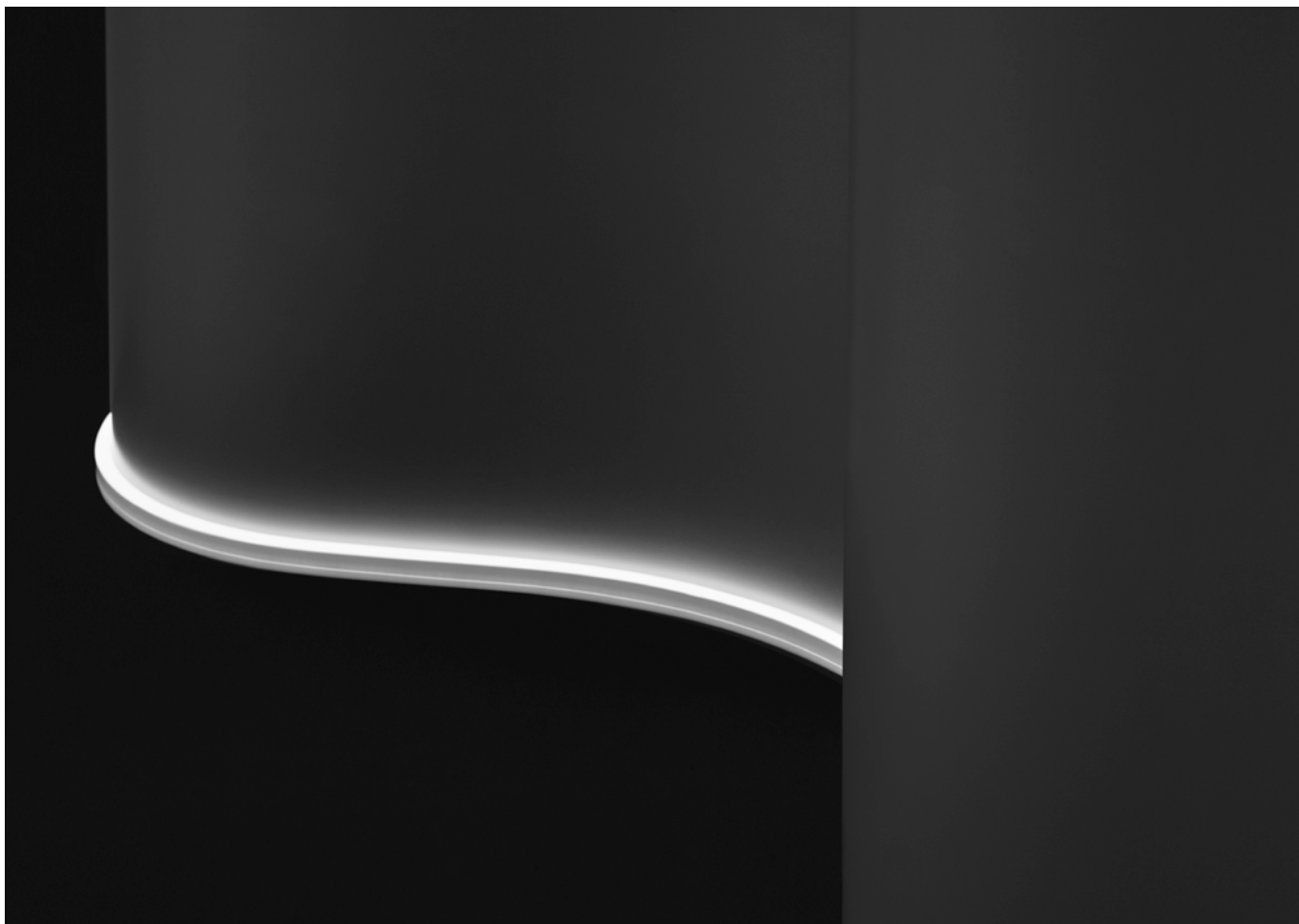

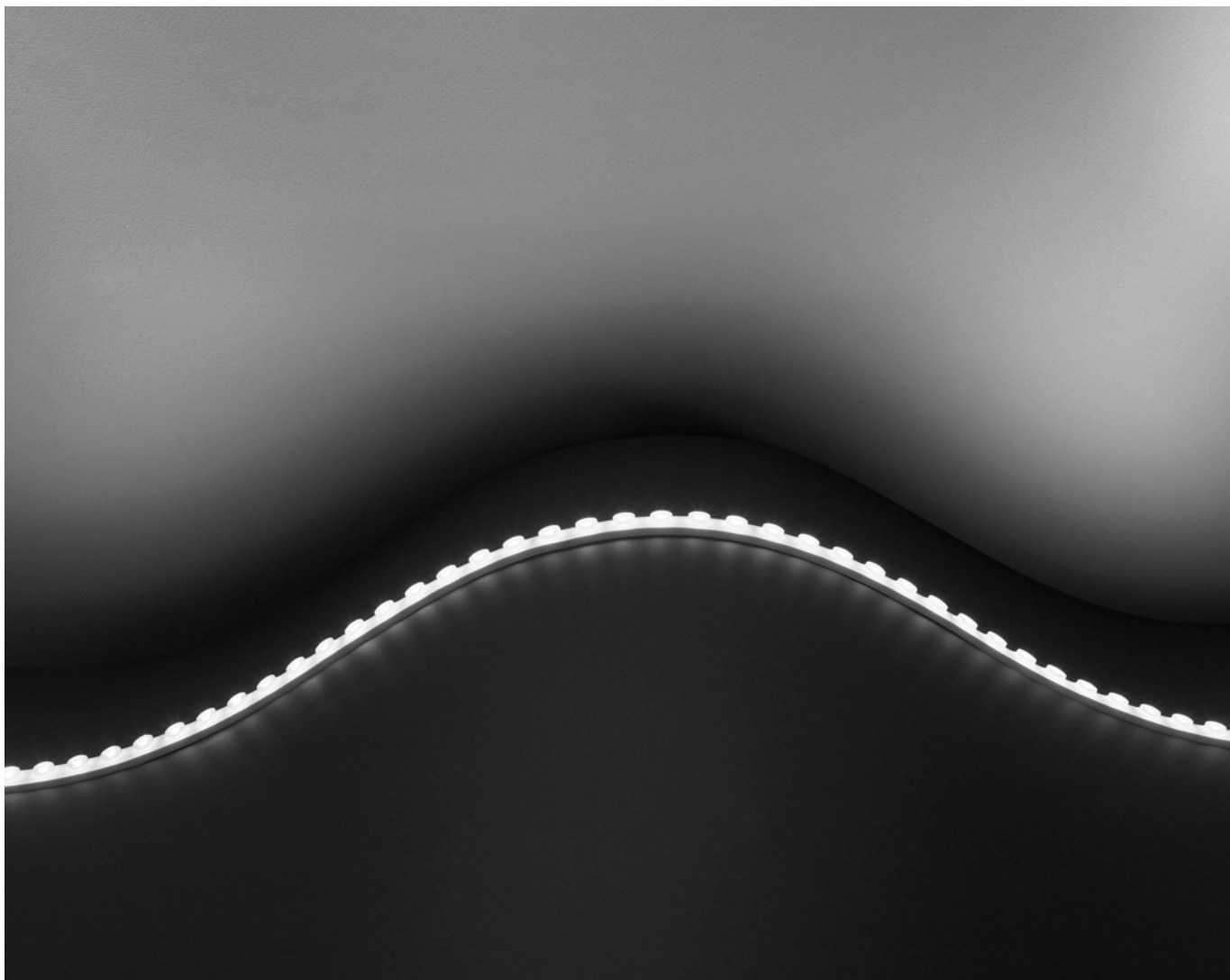

Hydroflex Optics

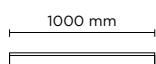

Code Example

402901.30.30.OP.0

Accessories p. 231

PRODUCT WEIGHT 0,30 kg



Hydroflex Optics 1000

1.000 mm length, 18.5mm x 9.5mm section, TOP bended encapsulated flexible LED strip for linear lighting, outdoor and indoor; LED circuit completely encapsulated with UV and high-temperatures resistant polyurethane sheath, complete with lenses for wall washing effect. Double power cable with male/female connectors included, suitable for in-line installation. Cuttable each 125 mm. Remote driver 24V DC needed. With nr. 48 Lumileds LED per meter. IP67 rating.

402901
18W

CCT	Beam Angle	lm	lm/w	Finish	Dimming
.30 3000°K	.30 30°	1.671	92.83	.OP <input type="checkbox"/> Milky	.0 ON/OFF
	.60 60°	1.644	91.34		

Remote Driver Selection

Brand	Manufacturer code	Type	Watt	IP Rate	Number of fixtures
Meanwell	LPV-20-24	constant voltage 24V DC	20W	IP67	1
Meanwell	LPV-60-24	constant voltage 24V DC	60W	IP67	min 1 - max 3
Meanwell	LPV-100-24	constant voltage 24V DC	100W	IP67	min 1 - max 5

4000 mm

PRODUCT WEIGHT 1,20 kg



Hydroflex Optics 4000

Code Example

402902 .30 .30 .OP .0

Accessories p. 231

4.000 mm length, 18.5mm x 9.5mm section, TOP bended encapsulated flexible LED strip for linear lighting, outdoor and indoor; LED circuit completely encapsulated with UV and high-temperatures resistant polyurethane sheath, complete with lenses for wall washing effect. Double power cable with male/female connectors included, suitable for in-line installation. Cuttable each 125 mm. Remote driver 24V DC needed. With nr. 48 Lumileds LED per meter. IP67 rating.

402902
72W

CCT	Beam Angle	lm	lm/w	Finish	Dimming
.30 3000°K	.30 30°	6.684	92.83	.OP <input type="checkbox"/> Milky	.0 ON/OFF
	.60 60°	6.576	91.34		

Remote Driver Selection

Brand	Manufacturer code	Type	Watt	IP Rate	Number of fixtures
Meanwell	LPV-100-24	constant voltage 24V DC	100W	IP67	1

HYDROFLEX OPTICS - SIDE SECTION

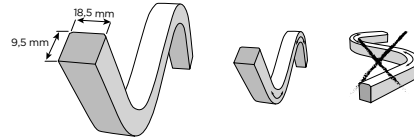
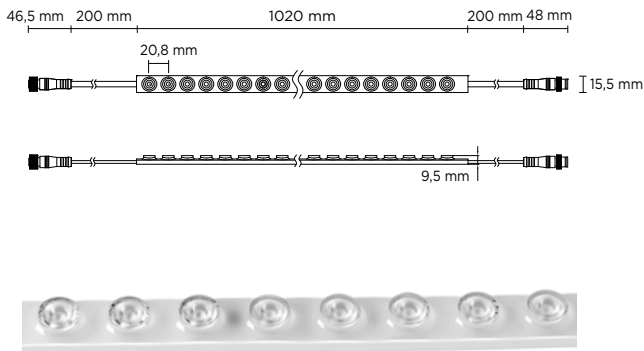

ACCESSORIES NOT INCLUDED

MOUNTING CLIP

Mounting clip for Hydroflex Optics realized in Stainless steel, clip to be applied every 40 cm, to secure with screws. Ideal for bended installations. Available for

ALUMINUM LINEAR PROFILE

1.000 mm Linear profile realized in Anodized aluminum. Available for

LEADER CABLE (MALE+FEMALE)

Initial cable to connect the driver to first luminaire of an in-line installation of multiple luminaires, all connected to one driver. Includes 1x male connector with 30 cm cable and 1x female connector with 30 cm cable. Available for

AC082

HYDROFLEX OPTICS ITEMS



AC083

HYDROFLEX OPTICS ITEMS



AC084

HYDROFLEX OPTICS ITEMS



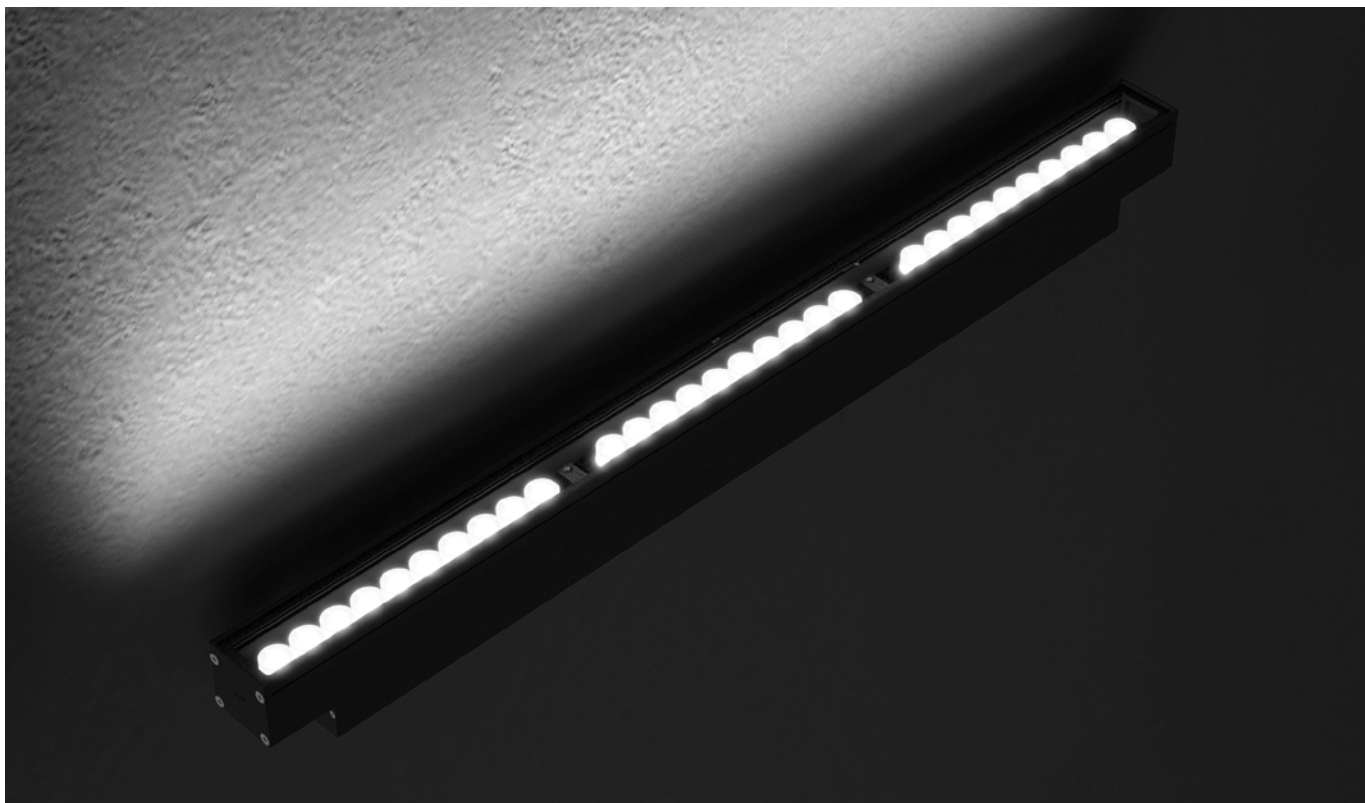

Lineafacade

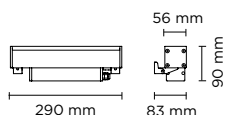

PRODUCT WEIGHT 1,70 kg

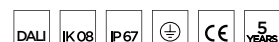

Lineafacade 300 HP

Code Example

403301.27.15.01.0

Accessories p. 242

290mm length linear luminaire for outdoor installation, surface mounted on a façade/wall with brackets, made in phospho-chromatised and polyester powder coated extruded copper-free aluminium, with tempered safety glass, moulded silicone gaskets. Built-in LED driver 220-240V 50-60Hz, with 12 x SAMSUNG 3030 LED. IP67 rating.

403301
12W

CCT	Beam Angle	Im	Im/w	Finish	Dimming
.27 2700°K	.15 15°	900	75.00	.01 RAL 9006	.0 ON/OFF
	.35 35°	870	72.50	.02 RAL 7016	.D DALI
	.55 55°	840	70.00	.03 Matt Black	
	.WW Asym.Wall Washer	870	72.50		
	.30 3000°K	.15 15°	930	77.50	
.35 35°		900	75.00		
.55 55°		870	72.50		
.WW Asym.Wall Washer		900	75.00		
.40 4000°K	.15 15°	960	80.00		
	.35 35°	930	77.50		
	.55 55°	900	75.00		
	.WW Asym.Wall Washer	930	77.50		

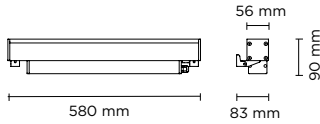

PRODUCT WEIGHT 3,00 kg



Lineafacade 600 HP

Code Example

403305.27.15.01.0

Accessories p. 242

580mm length linear luminaire for outdoor installation, surface mounted on a façade/wall with brackets, made in phospho-chromatised and polyester powder coated extruded copper-free aluminium, with tempered safety glass, moulded silicone gaskets. Built-in LED driver 220-240V 50-60Hz, with 24 x SAMSUNG 3030 LED. IP67 rating.

403305
24W

CCT	Beam Angle	lm	lm/w	Finish	Dimming
.27 2700°K	.15 15°	1.800	75.00	.01 RAL 9006	.0 ON/OFF
	.35 35°	1.740	72.50	.02 RAL 7016	.D DALI
	.55 55°	1.680	70.00	.03 Matt Black	
	.WW Asym.Wall Washer	1.740	72.50		
.30 3000°K	.15 15°	1.860	77.50		
	.35 35°	1.800	75.00		
	.55 55°	1.740	72.50		
	.WW Asym.Wall Washer	1.800	75.00		
.40 4000°K	.15 15°	1.920	80.00		
	.35 35°	1.860	77.50		
	.55 55°	1.800	75.00		
	.WW Asym.Wall Washer	1.860	77.50		

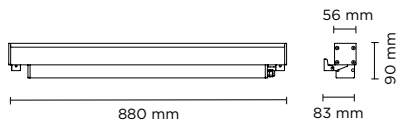

PRODUCT WEIGHT 4,50 kg



Lineafacade 900 HP

Code Example

403309.27.15.01.0

Accessories p. 242

880mm length linear luminaire for outdoor installation, surface mounted on a façade/wall with brackets, made in phospho-chromatised and polyester powder coated extruded copper-free aluminium, with tempered safety glass, moulded silicone gaskets. Built-in LED driver 220-240V 50-60Hz, with 36 x SAMSUNG 3030 LED. IP67 rating.

403309
36W

CCT	Beam Angle	lm	lm/w	Finish	Dimming
.27 2700°K	.15 15°	2.700	75.00	.01 RAL 9006	.0 ON/OFF
	.35 35°	2.610	72.50	.02 RAL 7016	.D DALI
	.55 55°	2.520	70.00	.03 Matt Black	
	.WW Asym.Wall Washer	2.610	72.50		
.30 3000°K	.15 15°	2.790	77.50		
	.35 35°	2.700	75.00		
	.55 55°	2.610	72.50		
	.WW Asym.Wall Washer	2.700	75.00		
.40 4000°K	.15 15°	2.880	80.00		
	.35 35°	2.790	77.50		
	.55 55°	2.700	75.00		
	.WW Asym.Wall Washer	2.790	77.50		

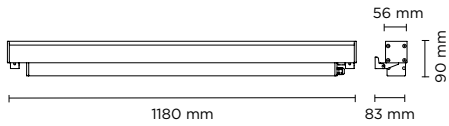

PRODUCT WEIGHT 6,00 kg

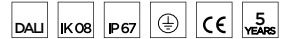

Lineafacade 1200 HP

Code Example

403313 .27 .15 .01 .0

Accessories p. 242

1190mm length linear luminaire for outdoor installation, surface mounted on a façade/wall with brackets, made in phospho-chromatised and polyester powder coated extruded copper-free aluminium, with tempered safety glass, moulded silicone gaskets. Built-in LED driver 220-240V 50-60Hz, with 48 x SAMSUNG 3030 LED. IP67 rating.

CCT	Beam Angle	lm	lm/w	Finish	Dimming
403313 48W	.27 2700°K	.15 15°	3.600 75.00	.01 RAL 9006	.0 ON/OFF
		.35 35°	3.480 72.50		
		.55 55°	3.360 70.00		
		.WW <small>Asym.Wall Washer</small>	3.480 72.50		
.30 3000°K	.15 15°	3.720 77.50	.02 RAL 7016	.D DALI	
		.35 35°			3.600 75.00
		.55 55°			3.480 72.50
		.WW <small>Asym.Wall Washer</small>			3.600 75.00
.40 4000°K	.15 15°	3.840 80.00	.03 Matt Black		
		.35 35°			3.720 77.50
		.55 55°			3.600 75.00
		.WW <small>Asym.Wall Washer</small>			3.720 77.50

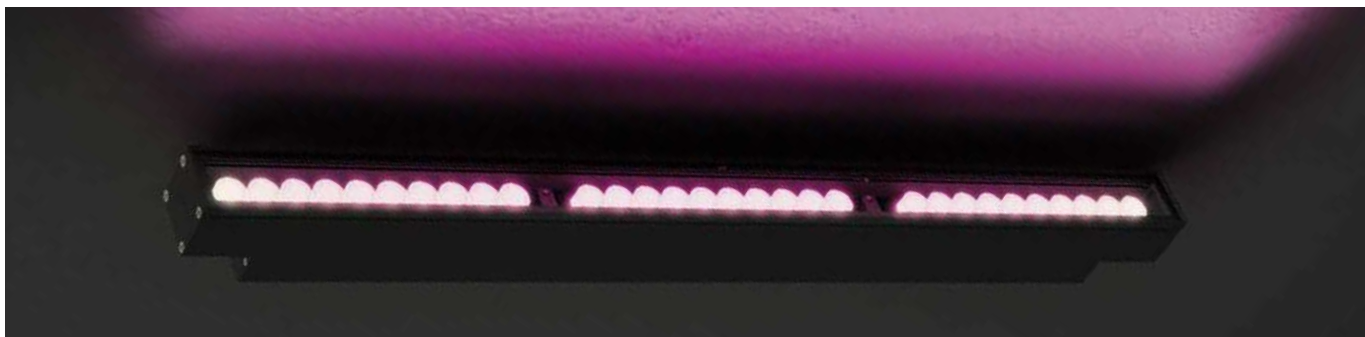

Lineafacade HP DMX RGBW

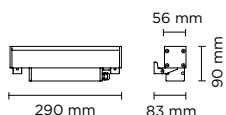

PRODUCT WEIGHT 1,70 kg

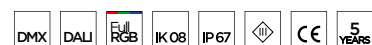

Lineafacade 300 HP DMX RGBW

Code Example

403302.RW.15.01.X

Accessories p. 242

290mm length linear luminaire for outdoor installation, surface mounted on a façade/wall with brackets, made in phospho-chromatised and polyester powder coated extruded copper-free aluminium, with tempered safety glass, moulded silicone gaskets. Remote 24V DC power supply needed, DMX interface integrated, with 12 x RGBW(3000K) 3535 LED. IP67 rating.

403302
10W

CCT	Beam Angle	lm	lm/w
.RW RGBW 3000°	.15 15°	380	38.00
	.30 30°	365	36.50
	.60 60°	335	33.50
	.E6 10X60° elliptical	365	36.50

Finish

.01	RAL 9006
.02	RAL 7016
.03	Matt Black

Dimming

.X	DMX
.D	DALI

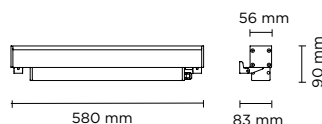

PRODUCT WEIGHT 3,00 kg



Lineafacade 600 HP DMX RGBW

Code Example

403306.RW.15.01.X

Accessories p. 242

580mm length linear luminaire for outdoor installation, surface mounted on a façade/wall with brackets, made in phospho-chromatised and polyester powder coated extruded copper-free aluminium, with tempered safety glass, moulded silicone gaskets. Built-in LED driver 220-240V 50-60Hz, DMX interface integrated, with 24 x RGBW(3000K) 3535 LED. IP67 rating.

403306
20W

CCT	Beam Angle	lm	lm/w
.RW RGBW 3000°	.15 15°	760	38.00
	.30 30°	730	36.50
	.60 60°	670	33.50
	.E6 10X60° elliptical	730	36.50

Finish

.01	RAL 9006
.02	RAL 7016
.03	Matt Black

Dimming

.X	DMX
.D	DALI

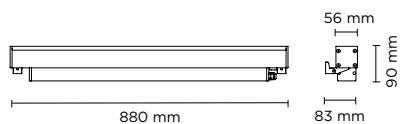

PRODUCT WEIGHT 4,50 kg

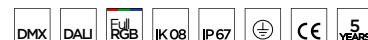

Code Example

403310.RW.15.01.X

Accessories p. 242

Lineafacade 900 HP DMX RGBW

880mm length linear luminaire for outdoor installation, surface mounted on a façade/wall with brackets, made in phospho-chromatised and polyester powder coated extruded copper-free aluminium, with tempered safety glass, moulded silicone gaskets. Built-in LED driver 220-240V 50-60Hz, DMX interface integrated, with 36 x RGBW(3000K) 3535 LED. IP67 rating.

CCT	Beam Angle	lm	lm/w	Finish	Dimming
403310 30W	.RW RGBW 3000°	.15 15°	1.140 38.00	.01 RAL 9006	.X DMX
		.30 30°	1.095 36.50	.02 RAL 7016	.D DALI
		.60 60°	1.005 33.50	.03 Matt Black	
		.E6 10X60° elliptical	1.095 36.50		

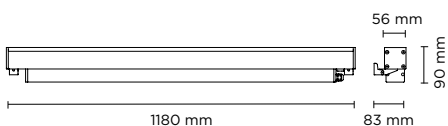

PRODUCT WEIGHT 6,00 kg

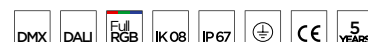

Code Example

403314.RW.15.01.X

Accessories p. 242

Lineafacade 1200 HP DMX RGBW

1190mm length linear luminaire for outdoor installation, surface mounted on a façade/wall with brackets, made in phospho-chromatised and polyester powder coated extruded copper-free aluminium, with tempered safety glass, moulded silicone gaskets. Built-in LED driver 220-240V 50-60Hz, DMX interface integrated, with 48 x RGBW(3000K) 3535 LED. IP67 rating.

CCT	Beam Angle	lm	lm/w	Finish	Dimming
403314 40W	.RW RGBW 3000°	.15 15°	1.520 38.00	.01 RAL 9006	.X DMX
		.30 30°	1.460 36.50	.02 RAL 7016	.D DALI
		.60 60°	1.340 33.50	.03 Matt Black	
		.E6 10X60° elliptical	1.460 36.50		



Lineafacade HP DMX Tunable White

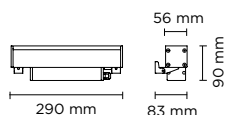

PRODUCT WEIGHT 1,70 kg



Lineafacade Hp 300 Dmx Tunable White

Code Example

403303.TW.15.01.X

Accessories p. 242

290mm length linear luminaire for outdoor installation, surface mounted on a façade/wall with brackets, made in phospho-chromatised and polyester powder coated extruded copper-free aluminium, with tempered safety glass, moulded silicone gaskets. Remote 24V DC power supply needed, DMX interface integrated, with 12 x Tunable White 3535 LED (2700K-5600K). IP67 rating.

403303
10W

CCT	Beam Angle	lm	lm/w
.TW 2700°K 5600°K	.15 15°	650	65.00
	.30 30°	635	63.50
	.60 60°	620	62.00
	.E6 10X60° elliptical	635	63.50

Finish

- .01 RAL 9006
- .02 RAL 7016
- .03 Matt Black

Dimming

- .X DMX
- .D DALI

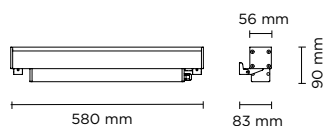

PRODUCT WEIGHT 3,00 kg



Lineafacade 600 HP DMX Tunable-White

Code Example

403307.TW.15.01.X

Accessories p. 242

580mm length linear luminaire for outdoor installation, surface mounted on a façade/wall with brackets, made in phospho-chromatised and polyester powder coated extruded copper-free aluminium, with tempered safety glass, moulded silicone gaskets. Built-in LED driver 220-240V 50-60Hz, DMX interface integrated, with 24 x Tunable White 3535 LED (2700K-5600K). IP67 rating.

403307
20W

CCT	Beam Angle	lm	lm/w
.TW 2700°K 5600°K	.15 15°	1.300	65.00
	.30 30°	1.270	63.50
	.60 60°	1.240	62.00
	.E6 10X60° elliptical	1.270	63.50

Finish

- .01 RAL 9006
- .02 RAL 7016
- .03 Matt Black

Dimming

- .X DMX
- .D DALI

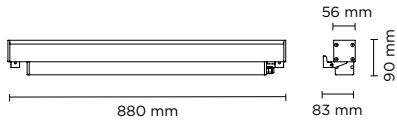

PRODUCT WEIGHT 4,50 kg



Lineafacade 900 HP DMX Tunable-White

Code Example

403311 .TW .15 .01 .X

Accessories p. 242

880mm length linear luminaire for outdoor installation, surface mounted on a façade/wall with brackets, made in phospho-chromatised and polyester powder coated extruded copper-free aluminium, with tempered safety glass, moulded silicone gaskets. Built-in LED driver 220-240V 50-60Hz, DMX interface integrated, with 36 x Tunable White 3535 LED (2700K-5600K). IP67 rating.

CCT	Beam Angle	Im		Finish	Dimming
		Im	Im/w		
.TW 2700°K 5600°K	.15 15°	1.950	65.00	.01 RAL 9006	.X DMX
	.30 30°	1.905	63.50	.02 RAL 7016	.D DALI
	.60 60°	1.860	62.00	.03 Matt Black	
	.E6 10X60° elliptical	1.905	63.50		

403311
30W

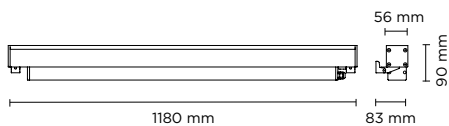

PRODUCT WEIGHT 6,00 kg



Lineafacade 1200 HP DMX Tunable-White

Code Example

403315 .TW .15 .01 .X

Accessories p. 242

1190mm length linear luminaire for outdoor installation, surface mounted on a façade/wall with brackets, made in phospho-chromatised and polyester powder coated extruded copper-free aluminium, with tempered safety glass, moulded silicone gaskets. Built-in LED driver 220-240V 50-60Hz, DMX interface integrated, with 48 x Tunable White 3535 LED (2700K-5600K). IP67 rating.

CCT	Beam Angle	Im		Finish	Dimming
		Im	Im/w		
.TW 2700°K 5600°K	.15 15°	2.600	65.00	.01 RAL 9006	.X DMX
	.30 30°	2.540	63.50	.02 RAL 7016	.D DALI
	.60 60°	2.480	62.00	.03 Matt Black	
	.E6 10X60° elliptical	2.540	63.50		

403315
40W

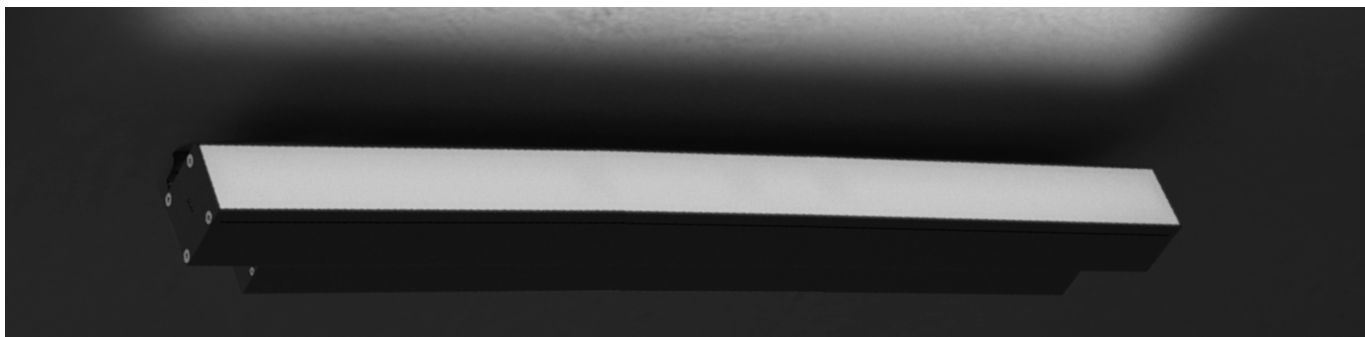

Lineafacade Diffused

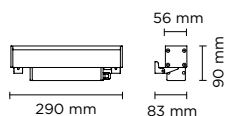

PRODUCT WEIGHT 1,70 kg

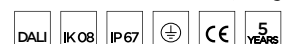

Code Example

403304.27.DF.01.0

Accessories p. 242

Lineafacade 300 Diffused

290mm length linear luminaire for outdoor installation, surface mounted on a façade/wall with brackets, made in phospho-chromatised and polyester powder coated extruded copper-free aluminium, with tempered safety glass, moulded silicone gaskets. Built-in LED driver 220-240V 50-60Hz, with 12 x SAMSUNG 3030 LED. IP67 rating.

403304

8W

CCT	Beam Angle	lm	lm/w
.27 2700°K	.DF Diffused	300	37.50
.30 3000°K	.DF Diffused	310	38.75
.40 4000°K	.DF Diffused	330	41.25

Finish

- .01 RAL 9006
- .02 RAL 7016
- .03 Matt Black

Dimming

- .0 ON/OFF
- .D DALI

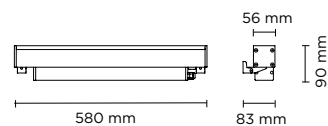

PRODUCT WEIGHT 3,00 kg

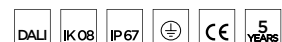

Code Example

403308.27.DF.01.0

Accessories p. 242

Lineafacade 600 Diffused

580mm length linear luminaire for outdoor installation, surface mounted on a façade/wall with brackets, made in phospho-chromatised and polyester powder coated extruded copper-free aluminium, with tempered safety glass, moulded silicone gaskets. Built-in LED driver 220-240V 50-60Hz, with 24 x SAMSUNG 3030 LED. IP67 rating.

403308

12W

CCT	Beam Angle	lm	lm/w
.27 2700°K	.DF Diffused	500	41.66
.30 3000°K	.DF Diffused	520	43.33
.40 4000°K	.DF Diffused	550	45.83

Finish

- .01 RAL 9006
- .02 RAL 7016
- .03 Matt Black

Dimming

- .0 ON/OFF
- .D DALI

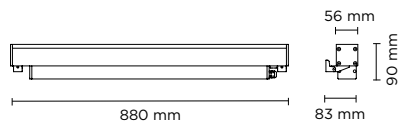

PRODUCT WEIGHT 4,50 kg

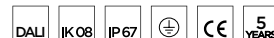

Lineafacade 900 Diffused

Code Example

403312 .27 .DF .01 .0

Accessories p. 242

880mm length linear luminaire for outdoor installation, surface mounted on a façade/wall with brackets, made in phospho-chromatised and polyester powder coated extruded copper-free aluminium, with tempered safety glass, moulded silicone gaskets. Built-in LED driver 220-240V 50-60Hz, with 36 x SAMSUNG 3030 LED. IP67 rating.

CCT	Beam Angle	lm	lm/w	Finish	Dimming	
403312 17W	.27 2700°K	.DF Diffused	780	45.88	.01 RAL 9006	.0 ON/OFF
	.30 3000°K	.DF Diffused	800	47.06	.02 RAL 7016	.D DALI
	.40 4000°K	.DF Diffused	830	48.80	.03 Matt Black	

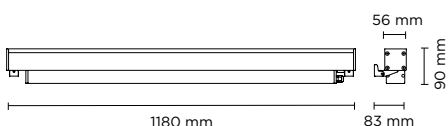

PRODUCT WEIGHT 6,00 kg

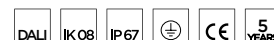

Lineafacade 1200 Diffused

Code Example

403316 .27 .DF .01 .0

Accessories p. 242

1190mm length linear luminaire for outdoor installation, surface mounted on a façade/wall with brackets, made in phospho-chromatised and polyester powder coated extruded copper-free aluminium, with tempered safety glass, moulded silicone gaskets. Built-in LED driver 220-240V 50-60Hz, with 48 x SAMSUNG 3030 LED. IP67 rating.

CCT	Beam Angle	lm	lm/w	Finish	Dimming	
403316 24W	.27 2700°K	.DF Diffused	1.010	42.08	.01 RAL 9006	.0 ON/OFF
	.30 3000°K	.DF Diffused	1.050	43.75	.02 RAL 7016	.D DALI
	.40 4000°K	.DF Diffused	1.100	45.83	.03 Matt Black	

PRODUCT OVERVIEW



REDUCED SPACING FOR SEAMLESS INSTALLATION WHEN JOINING ONE PRODUCT TO OTHER (3 MM)



MICRO-LOUVRE



BRACKETS IN VARIOUS LENGTHS TO ACHIEVE PERFECT LIGHTING EFFECT ON THE WALL

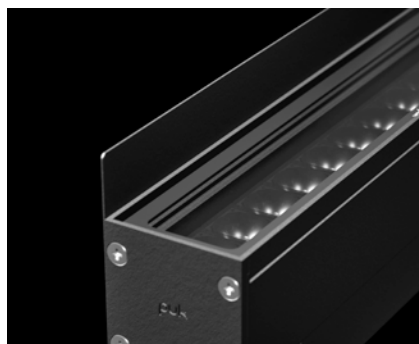

ANTI-GLARE SINGLE SHIELD



VARIETY OF LIGHT SOURCE & MODELS

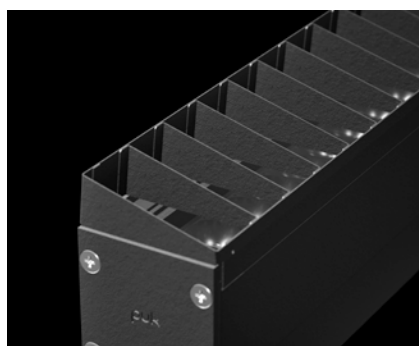

ANTI-GLARE ASYMMETRIC SHIELD

LIGHT BEAM OPTIONS



NARROW 15°

MEDIUM 30°

MEDIUM WIDE 35°

WIDE FLOOD 55°

WIDE FLOOD 60°

10x60° ELLIPTICAL

ASYMMETRIC WALL-WASHER

DIFFUSED

INTEGRATED ACCESSORIES

403301.27.15.01.0. --

Built-in accessories to be requested when ordering
example 403301.27.15.01.0.ML



.ML

MICROLOUVRE

Anti-glare grid that sections the light beam into microcells, adding visual comfort without compromising the quality or homogeneity of the light.

Available for:

- LINEAFACADE HP ITEMS
- LINEAFACADE HP DMX RGBW ITEMS
- LINEAFACADE HP DMX TUNABLE WHITE ITEMS
- LINEAFACADE DIFFUSED ITEMS

ACCESSORIES NOT INCLUDED

Accessories to be ordered separately.



ANTI-GLARE SINGLE SHIELD

Anti-glare single shield, improving visual comfort on the outer side.

AC141-300

Available for:

- LINEAFACADE 300 HP ITEMS
- LINEAFACADE 300 HP DMX RGBW ITEMS
- LINEAFACADE 300 HP DMX TUNABLE WHITE ITEMS

AC141-600

Available for:

- LINEAFACADE 600 HP ITEMS
- LINEAFACADE 600 HP DMX RGBW ITEMS
- LINEAFACADE 600 HP DMX TUNABLE WHITE ITEMS

AC141-900

Available for:

- LINEAFACADE 900 HP ITEMS
- LINEAFACADE 900 HP DMX RGBW ITEMS
- LINEAFACADE 900 HP DMX TUNABLE WHITE ITEMS

AC141-1200

Available for:

- LINEAFACADE 1200 HP ITEMS
- LINEAFACADE 1200 HP DMX RGBW ITEMS
- LINEAFACADE 1200 HP DMX TUNABLE WHITE ITEMS



ANTI-GLARE ASYMMETRIC SHIELD SINGLE COLOR

Anti-glare asymmetrical shield for single-color Lineafaçade range, conferring very high glare control: each optic is individually shielded.

AC142-300

Available for:

- LINEAFACADE 300 HP ITEMS
- LINEAFACADE 300 DIFFUSED ITEMS

AC142-600

Available for:

- LINEAFACADE 600 HP ITEMS
- LINEAFACADE 600 DIFFUSED ITEMS

AC142-900

Available for:

- LINEAFACADE 900 HP ITEMS
- LINEAFACADE 900 DIFFUSED ITEMS

AC142-1200

Available for:

- LINEAFACADE 1200 HP ITEMS
- LINEAFACADE 1200 DIFFUSED ITEMS



ANTI-GLARE ASYMMETRIC SHIELD

Anti-glare asymmetrical shield for RGBW/TW Lineafaçade range, conferring very high glare control: each optic is individually shielded.

AC143-300

Available for:

- LINEAFACADE 300 HP DMX RGBW ITEMS
- LINEAFACADE 300 HP DMX TUNABLE WHITE ITEMS

AC143-600

Available for:

- LINEAFACADE 600 HP DMX RGBW ITEMS
- LINEAFACADE 600 HP DMX TUNABLE WHITE ITEMS

AC143-900

Available for:

- LINEAFACADE 900 HP DMX RGBW ITEMS
- LINEAFACADE 900 HP DMX TUNABLE WHITE ITEMS

AC143-1200

Available for:

- LINEAFACADE 1200 HP DMX RGBW ITEMS
- LINEAFACADE 1200 HP DMX TUNABLE WHITE ITEMS



AC144

PAIR OF LONGER BRACKETS L 100MM

100mm length extension fixing brackets (2x), to increase the distance of Lineafaçade from the wall.

Available for all:

- LINEAFACADE HP ITEMS
- LINEAFACADE HP DMX RGBW ITEMS
- LINEAFACADE HP DMX TUNABLE WHITE ITEMS
- LINEAFACADE DIFFUSED ITEMS



AC145

PAIR OF LONGER BRACKETS L 150MM

150mm length extension fixing brackets (2x), to increase the distance of Lineafaçade from the wall.

Available for:

- LINEAFACADE HP ITEMS
- LINEAFACADE HP DMX RGBW ITEMS
- LINEAFACADE HP DMX TUNABLE WHITE ITEMS
- LINEAFACADE DIFFUSED ITEMS



AC133

FEED CABLE 1 MT. ON/OFF

Initial cable 3 core, to start an in-line installation, cable length 1 meter. Open wires for mains connection and IP68 connector for fixture connection.

Available for:

- LINEAFACADE HP ITEMS
- LINEAFACADE HP DMX RGBW ITEMS
- LINEAFACADE HP DMX TUNABLE WHITE ITEMS
- LINEAFACADE DIFFUSED ITEMS



AC134

FEED CABLE 1 MT. DALI

Initial cable 5 core, to start an in-line DALI installation, cable length 1 meter. Open wires for mains connection and IP68 connector for fixture connection.

Available for:

- LINEAFACADE HP ITEMS
- LINEAFACADE DIFFUSED ITEMS



AC135

JUMPER CABLE 2 MT. ON/OFF

2 meters length extension, 3 core cable with male and female IP68 connectors (end to end).

Available for:

- LINEAFACADE HP ITEMS
- LINEAFACADE HP DMX RGBW ITEMS
- LINEAFACADE HP DMX TUNABLE WHITE ITEMS
- LINEAFACADE DIFFUSED ITEMS



AC136

JUMPER CABLE 2 MT. ON/OFF

2 meters length extension, 3 core cable with male and female IP68 connectors (end to end).

Available for:

- LINEAFACADE HP ITEMS
- LINEAFACADE DIFFUSED ITEMS



AC137

JUMPER CABLE 4 MT. ON/OFF

4 meters length extension, 3 core cable with male and female IP68 connectors (end to end).

Available for:

- LINEAFACADE HP ITEMS
- LINEAFACADE HP DMX RGBW ITEMS
- LINEAFACADE HP DMX TUNABLE WHITE ITEMS
- LINEAFACADE DIFFUSED ITEMS



AC138

JUMPER CABLE 4 MT. DALI

4 meters length extension, 5 core DALI cable with male and female IP68 connectors (end to end).

Available for:

- LINEAFACADE HP ITEMS
- LINEAFACADE DIFFUSED ITEMS



AC139

END CAP ON/OFF

End cap for connectors, to terminate the in-line installation of light fixture equipped with 3 core cable.

Available for:

- LINEAFACADE HP ITEMS
- LINEAFACADE HP DMX RGBW ITEMS
- LINEAFACADE HP DMX TUNABLE WHITE ITEMS
- LINEAFACADE DIFFUSED ITEMS



AC140

END CAP DALI

End cap for connectors, to terminate the in-line installation of light fixture equipped with 5 core cable (DALI).

Available for:

- LINEAFACADE HP ITEMS
- LINEAFACADE DIFFUSED ITEMS

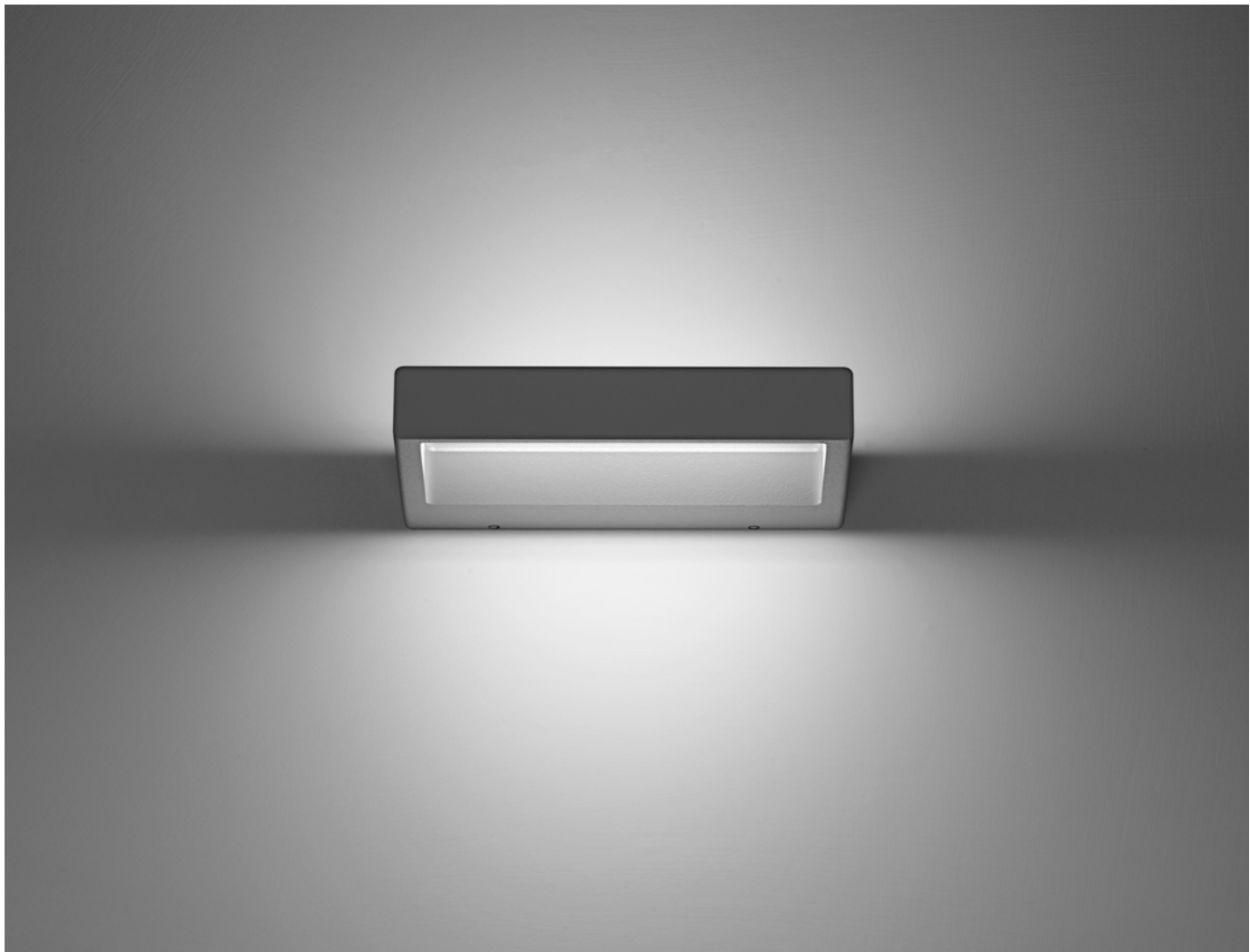

Horizon

Paolo Villa

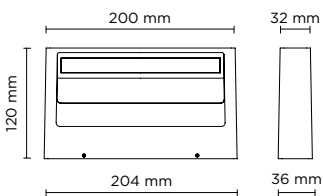

PRODUCT WEIGHT 1,50 kg





Code Example

402401, .27, .DF, .01, .0

Horizon Mini 01

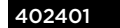
Applique of rectangular shape for outdoor installation on a façade/wall, with single (1 side) light emission. Phospho-chromatised and polyester powder coated die-cast copper-free aluminium body, tempered frosted safety glass, moulded silicone gasket and stainless steel screws. Built-in LED driver 220-240V 50-60Hz, with 10 mid-power CREE XH-G LED. IP65 rating.

	CCT	Beam Angle	lm	lm/w	Finish	Dimming
402401	.27 2700°K	.DF mono directional diffused	313	44.79	.01  RAL 9006	.0 ON/OFF
7W					.02  RAL 7016	
	.30 3000°K	.DF mono directional diffused	330	47.14	.03  RAL 9005	

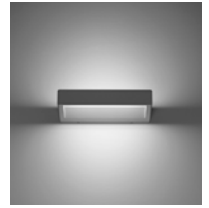
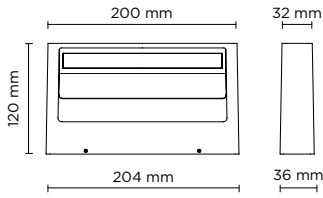

PRODUCT WEIGHT 1,50 kg



Code Example

402402.27.DF.01.0

Horizon Mini O2

Applique of rectangular shape for outdoor installation on a façade/wall, with double light emission (up/down). Phospho-chromatised and polyester powder coated die-cast copper-free aluminium body, tempered frosted safety glass, moulded silicone gasket and stainless steel screws. Built-in LED driver 220-240V 50-60Hz, with 20 mid-power CREE XH-G LED. IP65 rating.

402402
14W

CCT	Beam Angle	lm	lm/w	Finish	Dimming
.27 2700°K	.DF bi-directional diffused	617	44.11	.01 RAL 9006	.0 ON/OFF
.27 2700°K	.DF bi-directional diffused	617	44.11	.02 RAL 7016	.0 ON/OFF
.30 3000°K	.DF	650	46.43	.03 RAL 9005	.0 ON/OFF

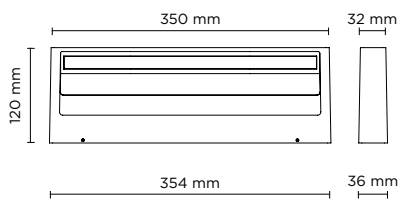

PRODUCT WEIGHT 1,50 kg



Code Example

402403.27.DF.01.0

Horizon Medium O1

Applique of rectangular shape for outdoor installation on a façade/wall, with single (1 side) light emission. Phospho-chromatised and polyester powder coated die-cast copper-free aluminium body, tempered frosted safety glass, moulded silicone gasket and stainless steel screws. Built-in LED driver 220-240V 50-60Hz, with 21 mid-power CREE XH-G LED. IP65 rating.

402403
12W

CCT	Beam Angle	lm	lm/w	Finish	Dimming
.27 2700°K	.DF mono directional diffused	545	45.44	.01 RAL 9006	.0 ON/OFF
.27 2700°K	.DF mono directional diffused	545	45.44	.02 RAL 7016	.0 ON/OFF
.30 3000°K	.DF mono directional diffused	574	47.83	.03 RAL 9005	.0 ON/OFF

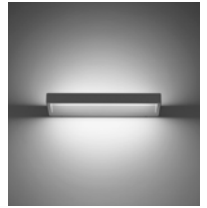
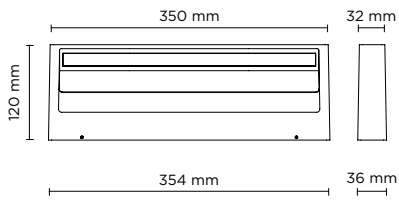

PRODUCT WEIGHT 3,00 kg





Horizon Medium O2

Code Example

402404.27.DF.01.0

Applique of rectangular shape for outdoor installation on a façade/wall, with double light emission (up/down). Phospho-chromatised and polyester powder coated die-cast copper-free aluminium body, tempered frosted safety glass, moulded silicone gasket and stainless steel screws. Built-in LED driver 220-240V 50-60Hz, with 42 mid-power CREE XH-G LED. IP65 rating.

	CCT	Beam Angle	lm	lm/w	Finish	Dimming
402404	.27 2700°K	.DF bi-directional diffused	1.144	49.73	.01  RAL 9006	.0 ON/OFF
23W	.30 3000°K	.DF bi-directional diffused	1.204	52.35	.02  RAL 7016	
					.03  RAL 9005	







Target

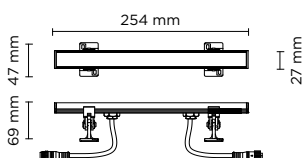

PRODUCT WEIGHT 0,20 kg



Code Example

406008 .30 .40 .01 .0

Accessories p. 249

406008
3W

Target 250

254 mm LED bar for outdoor installation on a wall; installation with two fixing holders, adjustable through 180°. Anodized aluminium body, tempered safety glass and stainless steel screws. Double power cable with male/female quick couplings included, suitable for in-line installation. Remote driver 24V DC needed. With nr. 6 x 0.5W Nichia mid-power LED. IP65 rating.

CCT	Beam Angle	lm	lm/w	Finish	Dimming
.30 3000°K	.40 40°	255	85	.01 RAL 9006	.0 ON/OFF

Remote Driver Selection

Brand	Manufacturer code	Type	Watt	IP Rate	Number of fixtures
Meanwell	LPV-20-24	constant voltage 24V DC	20W	IP67	min 1 - max 5
Meanwell	LPV-35-24	constant voltage 24V DC	35W	IP67	min 1 - max 10
Meanwell	LPV-60-24	constant voltage 24V DC	60W	IP67	min 1 - max 16

ACCESSORIES NOT INCLUDED

Accessories to be ordered separately.

LEADER CABLE

Initial cable to connect the driver to first luminaire of an in-line installation of multiple luminaires, all connected to one driver.

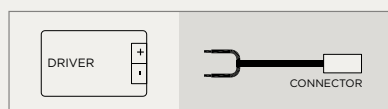

AC051

Compatible for all products of the series.

END CAP TERMINATOR

End cap for connectors, to terminate the in-line installation of light fixture.

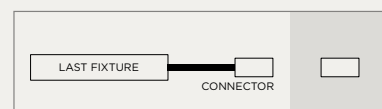

AC052

Compatible for all products of the series.

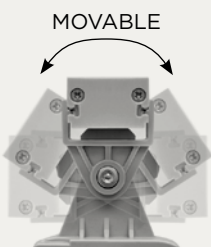

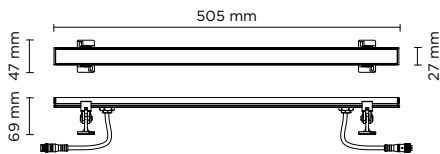

PRODUCT WEIGHT 0,30 kg



Target 500

Code Example

406006 . 30 . 40 . 01 . 0

Accessories p. 249

505 mm LED bar for outdoor installation on a wall; installation with two fixing holders, adjustable through 180°. Anodized aluminium body, tempered safety glass and stainless steel screws. Double power cable with male/female quick couplings included, suitable for in-line installation. Remote driver 24V DC needed. With nr. 12 x 0.5W Nichia mid-power LED. IP65 rating.

406006

6W

CCT	Beam Angle	lm	lm/w	Finish	Dimming
.30 3000°K	.40 40°	510	85	.01 RAL 9006	.0 ON/OFF

Remote Driver Selection

Brand	Manufacturer code	Type	Watt	IP Rate	Number of fixtures
Meanwell	LPV-20-24	constant voltage 24V DC	20W	IP67	min 1 - max 3
Meanwell	LPV-35-24	constant voltage 24V DC	35W	IP67	min 1 - max 5
Meanwell	LPV-60-24	constant voltage 24V DC	60W	IP67	min 1 - max 9

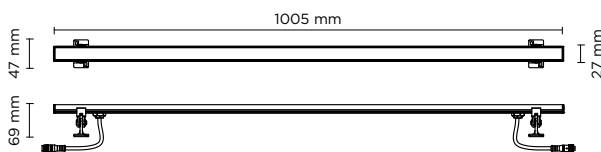

PRODUCT WEIGHT 0,50 kg



Target 1000

Code Example

406007 . 30 . 40 . 01 . 0

Accessories p. 249

1005 mm LED bar for outdoor installation on a wall; installation with two fixing holders, adjustable through 180°. Anodized aluminium body, tempered safety glass and stainless steel screws. Double power cable with male/female quick couplings included, suitable for in-line installation. Remote driver 24V DC needed. With nr. 24 x 0.5W Nichia mid-power LED. IP65 rating.

406007

12W

CCT	Beam Angle	lm	lm/w	Finish	Dimming
.30 3000°K	.40 40°	1.020	85	.01 RAL 9006	.0 ON/OFF

Remote Driver Selection

Brand	Manufacturer code	Type	Watt	IP Rate	Number of fixtures
Meanwell	LPV-20-24	constant voltage 24V DC	20W	IP67	1
Meanwell	LPV-35-24	constant voltage 24V DC	35W	IP67	min 1 - max 2
Meanwell	LPV-60-24	constant voltage 24V DC	60W	IP67	min 1 - max 4
Meanwell	LPV-100-24	constant voltage 24V DC	100W	IP67	min 1 - max 8

WALL

REC

ES

SED





Nanostep

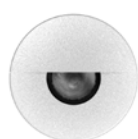
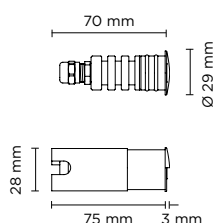

PRODUCT WEIGHT 0,50 kg



Code Example

505001 .27 .15 .01 0

Nanostep Round XXS

Round shape wall-recessed luminaire for outdoor installation. Body and frontal cover in hard anodized aluminum with phospho-chromatised and polyester powder coating, tempered safety glass, moulded silicone gasket. Asymmetrical light distribution. Remote constant current 350mA driver needed, with 1 CREE XP-G2 LED. IP68 rating.

505001

1W

CCT	Beam Angle	lm	lm/w	Finish	Dimming
.27 2700°K	.15 15°	65	65.00	.01 RAL 9006	.0 ON/OFF
	.30 30°	55	55.00	.02 RAL 7016	
	.45 45°	50	50.00	.03 Matt Black	
.30 3000°K	.15 15°	70	70.00		
	.30 30°	60	60.00		
	.45 45°	55	55.00		
.40 4000°K	.15 15°	80	80.00		
	.30 30°	70	70.00		
	.45 45°	65	65.00		

Remote Driver Selection

Brand	Manufacturer code	Type	Watt	IP Rate	Number of fixtures
ALVIT Italy	AL1435S-IP	constant current 350mA	14W	IP67	min 1 - max 8
Meanwell	LPC-20-350	constant current 350mA	16.8W	IP67	min 4 - max 12

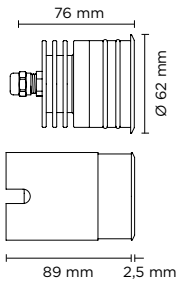

PRODUCT WEIGHT 1,00 kg



Code Example

505002 .27 .8 .01 .0

Nanostep Round XS

Round shape wall-recessed luminaire for outdoor installation. Body and frontal cover in hard anodized aluminum with phospho-chromatised and polyester powder coating, tempered safety glass, moulded silicone gasket. Asymmetrical oval wide light distribution. Remote constant current max 700mA driver needed, with 1 CREE XP-L LED. IP68 rating.

505002
Max 2,5W

CCT	Beam Angle	Finish	Dimming
.27 2700°K	.08 8°	.01 RAL 9006	.0 ON/OFF
	.40 40°	.02 RAL 7016	
.30 3000°K	.08 8°	.03 Matt Black	
	.40 40°		
.40 4000°K	.08 8°		
	.40 40°		

CCT	Beam Angle	350 mA LED POWER 1.2W		500 mA LED POWER 1.7W		700 mA LED POWER 2.5W	
		lm	lm/w	lm	lm/w	lm	lm/w
2700°K	8°	130	108.33	184	108.33	271	108.33
	40°	120	100.00	170	100.00	250	100.00
3000°K	8°	135	112.50	191	112.50	281	112.50
	40°	125	104.17	177	104.17	260	104.17
4000°K	8°	145	120.83	205	120.83	302	120.83
	40°	135	112.50	191	112.50	281	112.50

Remote Driver Selection

Brand	Manufacturer code	Type	Watt	IP Rate	Number of fixtures
ALVIT Italy	AL1435S-IP	constant current 350mA	14W	IP67	min 1 - max 8
ALVIT Italy	AL1450S-IP	constant current 500mA	14W	IP67	min 1 - max 6
ALVIT Italy	AL1470S-IP	constant current 700mA	14W	IP67	min 1 - max 4

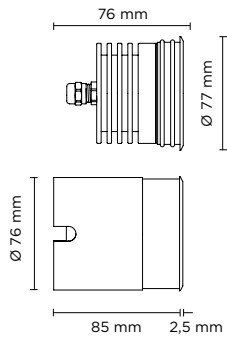

PRODUCT WEIGHT 1,30 kg



Nanostep Round

Round shape wall-recessed luminaire for outdoor installation. Body and frontal cover in hard anodized aluminum with phospho-chromatised and polyester powder coating, tempered safety glass, moulded silicone gasket. Asymmetrical oval wide light distribution. Remote constant current max 700mA driver needed, with 1 CREE XHP35 LED. IP68 rating.

Code Example

505003.**27**.**E4**.**01**.**0**

505003

Max 10W

CCT	Beam Angle	Finish	Dimming
.27 2700°K	.E4 8°x35° elliptical	.01 RAL 9006	.0 ON/OFF
.30 3000°K	.E4 8°x35° elliptical	.02 RAL 7016	
.40 4000°K	.E4 8°x35° elliptical	.03 Matt Black	

CCT	Beam Angle	350 mA LED POWER 5W		500 mA LED POWER 8W		700 mA LED POWER 10W	
		lm	lm/w	lm	lm/w	lm	lm/w
2700°K	8°x35° elliptical	460	92.00	622	77.75	836	83.60
3000°K	8°x35° elliptical	474	94.80	642	80.25	846	84.60
4000°K	8°x35° elliptical	484	96.80	656	82.00	863	86.30

Remote Driver Selection

Brand	Manufacturer code	Type	Watt	IP Rate	Number of fixtures
ALVIT Italy	AL1435S-IP	constant current 350mA	14W	IP67	min 1 - max 2
ALVIT Italy	AL1450S-IP	constant current 500mA	14W	IP67	1
ALVIT Italy	AL1470S-IP	constant current 700mA	14W	IP67	1
TCI Italy	152014/350	constant current 350mA	17W	IP68	min 1 - max 3
TCI Italy	152014/500	constant current 500mA	24W	IP68	min 1 - max 3
TCI Italy	152014/700	constant current 700mA	30W	IP68	min 1 - max 3



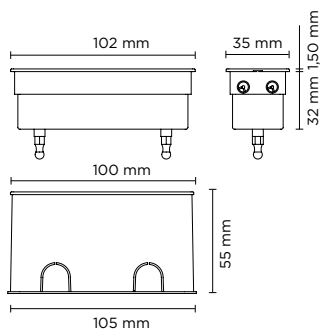

Code Example

505004 .27 .E1 .01 .0

505004

Max 6W



PRODUCT WEIGHT 0,50 kg



Nanostep Linear

Linear shape wall-recessed luminaire for outdoor installation. Body and frontal cover in hard anodized aluminum with phospho-chromatised and polyester powder coating, tempered safety glass, moulded silicone gasket. Asymmetrical oval wide light distribution. Remote constant current max 700mA driver needed, with 3 CREE XP-G2 LED. IP68 rating.

CCT	Beam Angle	Finish	Dimming
.27 2700°K	.E1 10°x45° elliptical	.01 RAL 9006	.0 ON/OFF
.30 3000°K	.E1 10°x45° elliptical	.02 RAL 7016	
.40 4000°K	.E1 10°x45° elliptical	.03 Matt Black	

CCT	Beam Angle	350 mA LED POWER 3W		500 mA LED POWER 4,5W		700 mA LED POWER 6W	
		lm	lm/w	lm	lm/w	lm	lm/w
2700°K	10°x45°	278	92.80	350	77.75	501	83.60
3000°K	10°x45°	284	94.80	360	80.25	507	84.60
4000°K	10°x45°	290	96.80	369	82.00	518	86.30

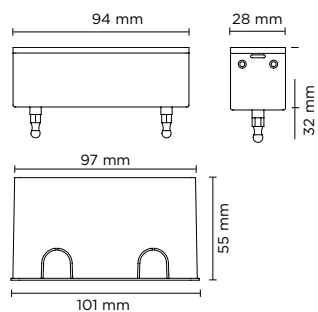

Code Example

505005 .27 .E1 .GL .0

505005

Max 6W



PRODUCT WEIGHT 0,50 kg



Nanostep Linear Trimless

Trimless version, all other details are same as model 505004.

CCT	Beam Angle	Finish	Dimming
.27 2700°K	.E1 10°x45° elliptical	.GL Clear glass	.0 ON/OFF
.30 3000°K	.E1 10°x45° elliptical		
.40 4000°K	.E1 10°x45° elliptical		

Remote Driver Selection

Brand	Manufacturer code	Type	Watt	IP Rate	Number of fixtures
ALVIT Italy	AL1435S-IP	constant current 350mA	14W	IP67	min 1 - max 4
ALVIT Italy	AL1450S-IP	constant current 500mA	14W	IP67	min 1 - max 3
ALVIT Italy	AL1470S-IP	constant current 700mA	14W	IP67	min 1 - max 2
TCI Italy	152014/350	constant current 350mA	17W	IP68	min 1 - max 5
TCI Italy	152014/500	constant current 500mA	24W	IP68	min 1 - max 5
TCI Italy	152014/700	constant current 700mA	30W	IP68	min 1 - max 4



Passoluce

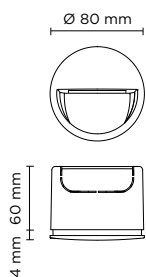

PRODUCT WEIGHT 0,50 kg



Code Example

506001,.27,.FW,.01,.0

Passoluce Mini Round

Round shape wall-recessed luminaire with floor-washer light distribution for outdoor installation, phospho-chromatised and polyester powder coated diecast copper-free aluminium body, tempered sand-blasted glass diffuser, moulded silicone gaskets, polypropylene housing for recess. Remote constant voltage 24V DC power supply needed. IP66 rating.

506001

3W

CCT	Beam Angle	Im	Im/w	Finish	Dimming
.27 2700°K	.FW Floor Washer	110	36.60	.01 RAL 9006	.0 ON/OFF
.30 3000°K	.FW Floor Washer	120	40.00	.02 RAL 7016	
.40 4000°K	.FW Floor Washer	140	46.60	.03 RAL 9005	

Remote Driver Selection

Brand	Manufacturer code	Type	Watt	IP Rate	Number of fixtures
Meanwell	LPV-20-24	Contant voltage 24V DC	20W	IP67	min 1 - max 4
Meanwell	LPV-35-24	Contant voltage 24V DC	35W	IP67	min 1 - max 8

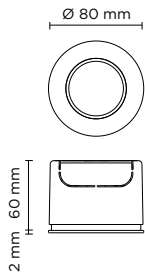

PRODUCT WEIGHT 0,50 kg



Code Example

506002·27·DF·01·0

Passoluce Mini Round Diffused

Round shape wall-recessed luminaire with diffused light distribution for outdoor installation, phospho-chromatised and polyester powder coated diecast copper-free aluminium body, tempered sand-blasted glass diffuser, moulded silicone gaskets, polypropylene housing for recess. Remote constant voltage 24V DC power supply needed. IP66 rating.

506002

3W

CCT	Beam Angle	lm	lm/w	Finish	Dimming
.27 2700°K	.DF Diffused	120	40.00	.01 RAL 9006	.0 ON/OFF
.30 3000°K	.DF Diffused	130	43.33	.02 RAL 7016	
.40 4000°K	.DF Diffused	150	50.00	.03 RAL 9005	

Remote Driver Selection

Brand	Manufacturer code	Type	Watt	IP Rate	Number of fixtures
Meanwell	LPV-20-24	Contant voltage 24V DC	20W	IP67	min 1 - max 4
Meanwell	LPV-35-24	Contant voltage 24V DC	35W	IP67	min 1 - max 8

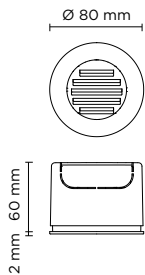

PRODUCT WEIGHT 0,50 kg



Code Example

506003·27·DF·01·0

Passoluce Mini Round Grid

Round shape wall-recessed luminaire with diffused light distribution for outdoor installation, phospho-chromatised and polyester powder coated diecast copper-free aluminium body and protection grid, tempered sand-blasted glass diffuser, moulded silicone gaskets, polypropylene housing for recess. Remote constant voltage 24V DC power supply needed. IP66 rating.

506003

3W

CCT	Beam Angle	lm	lm/w	Finish	Dimming
.27 2700°K	.DF Diffused	110	36.60	.01 RAL 9006	.0 ON/OFF
.30 3000°K	.DF Diffused	120	40.00	.02 RAL 7016	
.40 4000°K	.DF Diffused	140	46.60	.03 RAL 9005	

Remote Driver Selection

Brand	Manufacturer code	Type	Watt	IP Rate	Number of fixtures
Meanwell	LPV-20-24	Contant voltage 24V DC	20W	IP67	min 1 - max 4
Meanwell	LPV-35-24	Contant voltage 24V DC	35W	IP67	min 1 - max 8

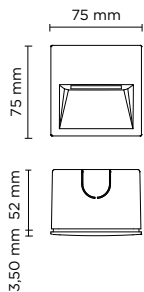

Code Example

506004·.27·.FW·.01·.0



PRODUCT WEIGHT 0,50 kg

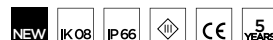

Passoluce Mini Square

Square shape wall-recessed luminaire with floor-wahser light distribution for outdoor installation, phospho-chromatised and polyester powder coated diecast copper-free aluminium body, tempered sand-blasted glass diffuser, moulded silicone gaskets, polypropylene housing for recess.

Remote constant voltage 24V DC power supply needed. IP66 rating.

506004

3W

CCT	Beam Angle	Im	Im/w	Finish	Dimming
.27 2700°K	.FW Floor Washer	110	36.60	.01 RAL 9006	.0 ON/OFF
.30 3000°K	.FW Floor Washer	120	40.00	.02 RAL 7016	
.40 4000°K	.FW Floor Washer	140	46.60	.03 RAL 9005	

Remote Driver Selection

Brand	Manufacturer code	Type	Watt	IP Rate	Number of fixtures
Meanwell	LPV-20-24	Contant voltage 24V DC	20W	IP67	min 1 - max 4
Meanwell	LPV-35-24	Contant voltage 24V DC	35W	IP67	min 1 - max 8

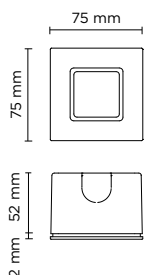

Code Example

506005·.27·.DF·.01·.0

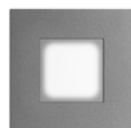

PRODUCT WEIGHT 0,50 kg



Passoluce Mini Square Diffused

Square shape wall-recessed luminaire with diffused light distribution for outdoor installation, phospho-chromatised and polyester powder coated diecast copper-free aluminium body, tempered sand-blasted glass diffuser, moulded silicone gaskets, polypropylene housing for recess.

Remote constant voltage 24V DC power supply needed. IP66 rating.

506005

3W

CCT	Beam Angle	Im	Im/w	Finish	Dimming
.27 2700°K	.DF Diffused	120	40.00	.01 RAL 9006	.0 ON/OFF
.30 3000°K	.DF Diffused	130	43.33	.02 RAL 7016	
.40 4000°K	.DF Diffused	150	50.00	.03 RAL 9005	

Remote Driver Selection

Brand	Manufacturer code	Type	Watt	IP Rate	Number of fixtures
Meanwell	LPV-20-24	Contant voltage 24V DC	20W	IP67	min 1 - max 4
Meanwell	LPV-35-24	Contant voltage 24V DC	35W	IP67	min 1 - max 8

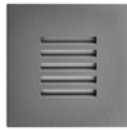
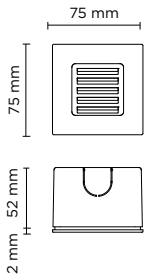

PRODUCT WEIGHT 0,50 kg



Code Example

506006·.27·.DF·.01·.0

Passoluce Mini Square Grid

Square shape wall-recessed luminaire with diffused light distribution for outdoor installation, phospho-chromatised and polyester powder coated diecast copper-free aluminium body and protection grid, tempered sand-blasted glass diffuser, moulded silicone gaskets, polypropylene housing for recess. Remote constant voltage 24V DC power supply needed. IP66 rating.

506006
3W

CCT	Beam Angle	lm	lm/w	Finish	Dimming
.27 2700°K	.DF Diffused	110	36.60	.01 RAL 9006	.0 ON/OFF
.30 3000°K	.DF Diffused	120	40.00	.02 RAL 7016	
.40 4000°K	.DF Diffused	140	46.60	.03 RAL 9005	

Remote Driver Selection

Brand	Manufacturer code	Type	Watt	IP Rate	Number of fixtures
Meanwell	LPV-20-24	Contant voltage 24V DC	20W	IP67	min 1 - max 4
Meanwell	LPV-35-24	Contant voltage 24V DC	35W	IP67	min 1 - max 8

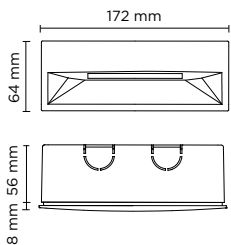

PRODUCT WEIGHT 0,80 kg



Code Example

506007·.27·.FW·.01·.0

Passoluce Mini Linear

Linear shape wall-recessed luminaire with floor-wahser light distribution for outdoor installation, phospho-chromatised and polyester powder coated diecast copper-free aluminium body, tempered sand-blasted glass diffuser, moulded silicone gaskets, polypropylene housing for recess. Remote constant voltage 24V DC power supply needed. IP66 rating.

506007
7W

CCT	Beam Angle	lm	lm/w	Finish	Dimming
.27 2700°K	.FW Floor Washer	238	34.00	.01 RAL 9006	.0 ON/OFF
.30 3000°K	.FW Floor Washer	248	35.43	.02 RAL 7016	
.40 4000°K	.FW Floor Washer	268	38.29	.03 RAL 9005	

Remote Driver Selection

Brand	Manufacturer code	Type	Watt	IP Rate	Number of fixtures
Meanwell	LPV-20-24	Contant voltage 24V DC	20W	IP67	min 1 - max 2
Meanwell	LPV-35-24	Contant voltage 24V DC	35W	IP67	min 1 - max 4

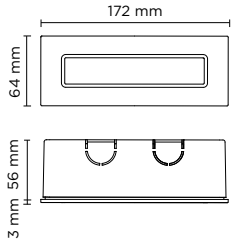

PRODUCT WEIGHT 0,8 kg



Code Example

506008,.27,.DF,.01,.0

Passoluce Mini Linear Diffused

Linear shape wall-recessed luminaire with diffused light distribution for outdoor installation, phospho-chromatised and polyester powder coated diecast copper-free aluminium body, tempered sand-blasted glass diffuser, moulded silicone gaskets, polypropylene housing for recess. Remote constant voltage 24V DC power supply needed. IP66 rating.

506008

7W

CCT	Beam Angle	Im	Im/w	Finish	Dimming
.27 2700°K	.DF Diffused	248	35.43	.01 RAL 9006	.0 ON/OFF
.30 3000°K	.DF Diffused	258	36.86	.02 RAL 7016	
.40 4000°K	.DF Diffused	278	39.71	.03 RAL 9005	

Remote Driver Selection

Brand	Manufacturer code	Type	Watt	IP Rate	Number of fixtures
Meanwell	LPV-20-24	Contant voltage 24V DC	20W	IP67	min 1 - max 2
Meanwell	LPV-35-24	Contant voltage 24V DC	35W	IP67	min 1 - max 4

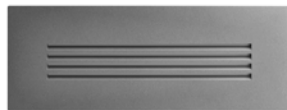
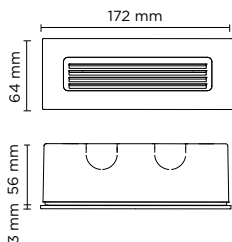

PRODUCT WEIGHT 0,80 kg



Code Example

506009,.27,.DF,.01,.0

Passoluce Mini Linear Grid

Linear shape wall-recessed luminaire with diffused light distribution for outdoor installation, phospho-chromatised and polyester powder coated diecast copper-free aluminium body, tempered sand-blasted glass diffuser, moulded silicone gaskets, polypropylene housing for recess. Remote constant voltage 24V DC power supply needed. IP66 rating.

506009

7W

CCT	Beam Angle	Im	Im/w	Finish	Dimming
.27 2700°K	.DF Diffused	238	34.00	.01 RAL 9006	.0 ON/OFF
.30 3000°K	.DF Diffused	248	35.43	.02 RAL 7016	
.40 4000°K	.DF Diffused	268	38.29	.03 RAL 9005	

Remote Driver Selection

Brand	Manufacturer code	Type	Watt	IP Rate	Number of fixtures
Meanwell	LPV-20-24	Contant voltage 24V DC	20W	IP67	min 1 - max 2
Meanwell	LPV-35-24	Contant voltage 24V DC	35W	IP67	min 1 - max 4

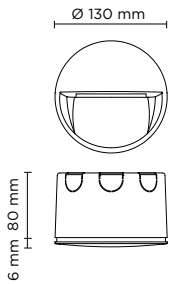

PRODUCT WEIGHT 1,00 kg



Code Example

506010,.27,.FW,.01,.0

Passoluce Medium Round

Round shape wall-recessed luminaire with floor-washer light distribution for outdoor installation, phospho-chromatised and polyester powder coated diecast copper-free aluminium body, tempered sand-blasted glass diffuser, moulded silicone gaskets, polypropylene housing for recess. Built-in driver 220-240V 50-60Hz. IP66 rating.

	CCT	Beam Angle		Im	Im/w	Finish	Dimming
506010	.27 2700°K	.FW Floor Washer		296	37.00	.01 RAL 9006	.0 ON/OFF
8W	.30 3000°K	.FW Floor Washer		306	38.25	.02 RAL 7016	.D DALI
	.40 4000°K	.FW Floor Washer		326	40.75	.03 RAL 9005	

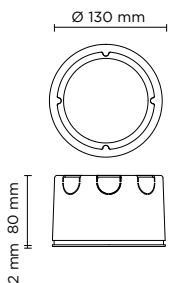

PRODUCT WEIGHT 1,00 kg



Code Example

506011,.27,.DF,.01,.0

Passoluce Medium Round Diffused

Round shape wall-recessed luminaire with diffused light distribution for outdoor installation, phospho-chromatised and polyester powder coated diecast copper-free aluminium body, tempered sand-blasted glass diffuser, moulded silicone gaskets, polypropylene housing for recess. Built-in driver 220-240V 50-60Hz. IP66 rating.

	CCT	Beam Angle		Im	Im/w	Finish	Dimming
506011	.27 2700°K	.DF Diffused		306	38.25	.01 RAL 9006	.0 ON/OFF
8W	.30 3000°K	.DF Diffused		316	39.50	.02 RAL 7016	.D DALI
	.40 4000°K	.DF Diffused		336	42.00	.03 RAL 9005	

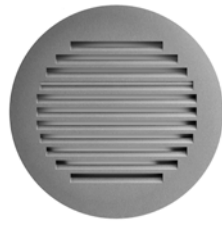
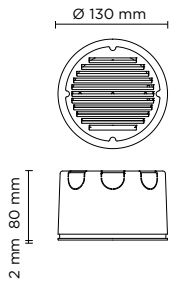

PRODUCT WEIGHT 1,00 kg



Code Example

506012 · .27 · .DF · .01 · .0

Passoluce Medium Round Grid

Round shape wall-recessed luminaire with diffused light distribution for outdoor installation, phospho-chromatised and polyester powder coated diecast copper-free aluminium body and protection grid, tempered sand-blasted glass diffuser, moulded silicone gaskets, polypropylene housing for recess. Built-in driver 220-240V 50-60Hz. IP66 rating.

506012

8W

CCT	Beam Angle	Im	Im/w	Finish	Dimming
.27 2700°K	.DF Diffused	296	37.00	.01 RAL 9006	.0 ON/OFF
.30 3000°K	.DF Diffused	306	38.25	.02 RAL 7016	.D DALI
.40 4000°K	.DF Diffused	326	40.75	.03 RAL 9005	

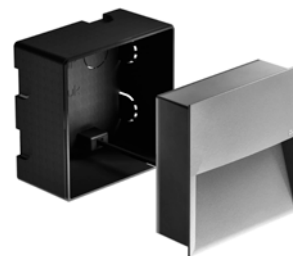
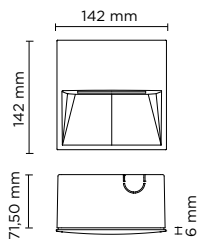

PRODUCT WEIGHT 1,00 kg



Code Example

506013 · .27 · .FW · .01 · .0

Passoluce Medium Square

Square shape wall-recessed luminaire with floor-wahser light distribution for outdoor installation, phospho-chromatised and polyester powder coated diecast copper-free aluminium body, tempered sand-blasted glass diffuser, moulded silicone gaskets, polypropylene housing for recess. Built-in driver 220-240V 50-60Hz. IP66 rating.

506013

8W

CCT	Beam Angle	Im	Im/w	Finish	Dimming
.27 2700°K	.FW Floor Washer	296	37.00	.01 RAL 9006	.0 ON/OFF
.30 3000°K	.FW Floor Washer	306	38.25	.02 RAL 7016	.D DALI
.40 4000°K	.FW Floor Washer	326	40.75	.03 RAL 9005	

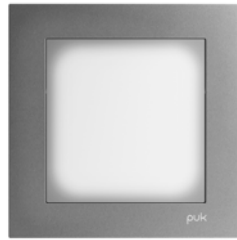
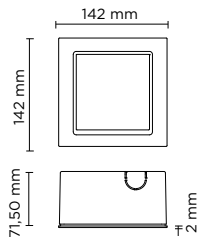

PRODUCT WEIGHT 1,00 kg



Code Example

506014.27.DF.01.0

Passoluce Medium Square Diffused

Square shape wall-recessed luminaire with diffused light distribution for outdoor installation, phospho-chromatised and polyester powder coated diecast copper-free aluminium body, tempered sand-blasted glass diffuser, moulded silicone gaskets, polypropylene housing for recess. Built-in driver 220-240V 50-60Hz. IP66 rating.

506014

8W

CCT	Beam Angle	lm	lm/w	Finish	Dimming
.27 2700°K	.DF Diffused	306	38.25	.01 RAL 9006	.0 ON/OFF
.30 3000°K	.DF Diffused	316	39.50	.02 RAL 7016	.D DALI
.40 4000°K	.DF Diffused	336	42.00	.03 RAL 9005	

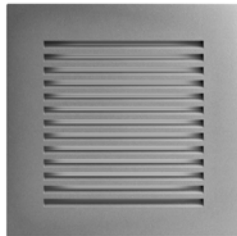
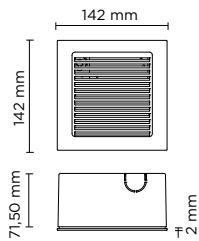

PRODUCT WEIGHT 1,00 kg



Code Example

506015.27.DF.01.0

Passoluce Medium Square Grid

Square shape wall-recessed luminaire with diffused light distribution for outdoor installation, phospho-chromatised and polyester powder coated diecast copper-free aluminium body and protection grid, tempered sand-blasted glass diffuser, moulded silicone gaskets, polypropylene housing for recess. Built-in driver 220-240V 50-60Hz. IP66 rating.

506015

8W

CCT	Beam Angle	lm	lm/w	Finish	Dimming
.27 2700°K	.DF Diffused	296	37.00	.01 RAL 9006	.0 ON/OFF
.30 3000°K	.DF Diffused	306	38.25	.02 RAL 7016	.D DALI
.40 4000°K	.DF Diffused	326	40.75	.03 RAL 9005	

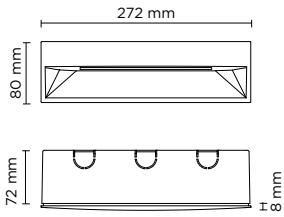

PRODUCT WEIGHT 1,60 kg



Code Example

506016,.27,.FW,.01,.0

Passoluce Medium Linear

Linear shape wall-recessed luminaire with floor-washer light distribution for outdoor installation, phospho-chromatised and polyester powder coated diecast copper-free aluminium body, tempered sand-blasted glass diffuser, moulded silicone gaskets, polypropylene housing for recess. Built-in driver 220-240V 50-60Hz. IP66 rating.

506016

11W

CCT	Beam Angle	lm	lm/w	Finish	Dimming
.27 2700°K	.FW Floor Washer	495	45.00	.01 RAL 9006	.0 ON/OFF
.30 3000°K	.FW Floor Washer	505	45.90	.02 RAL 7016	.D DALI
.40 4000°K	.FW Floor Washer	525	47.73	.03 RAL 9005	

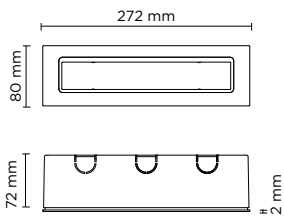

PRODUCT WEIGHT 1,60 kg



Code Example

506017,.27,.FW,.01,.0

Passoluce Medium Linear Diffused

Linear shape wall-recessed luminaire with diffused light distribution for outdoor installation, phospho-chromatised and polyester powder coated diecast copper-free aluminium body, tempered sand-blasted glass diffuser, moulded silicone gaskets, polypropylene housing for recess. Built-in driver 220-240V 50-60Hz. IP66 rating.

506017

11W

CCT	Beam Angle	lm	lm/w	Finish	Dimming
.27 2700°K	.DF Diffused	505	45.90	.01 RAL 9006	.0 ON/OFF
.30 3000°K	.DF Diffused	515	46.82	.02 RAL 7016	.D DALI
.40 4000°K	.DF Diffused	535	48.64	.03 RAL 9005	

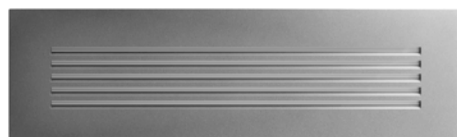
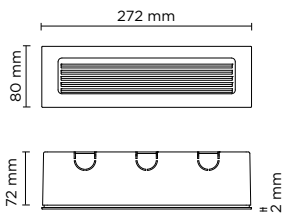

PRODUCT WEIGHT 1,60 kg



Code Example

506018,.27,.FW,.01,.0

Passoluce Medium Linear Grid

Lineat shape wall-recessed luminaire with diffused light distribution for outdoor installation, phospho-chromatised and polyester powder coated diecast copper-free aluminium body and protection grid, tempered sand-blasted glass diffuser, moulded silicone gaskets, polypropylene housing for recess. Built-in driver 220-240V 50-60Hz. IP66 rating.

506018

11W

CCT	Beam Angle	lm	lm/w	Finish	Dimming
.27 2700°K	.DF Diffused	495	45.00	.01 RAL 9006	.0 ON/OFF
.30 3000°K	.DF Diffused	505	45.90	.02 RAL 7016	.D DALI
.40 4000°K	.DF Diffused	525	47.73	.03 RAL 9005	

Accessories p. 13



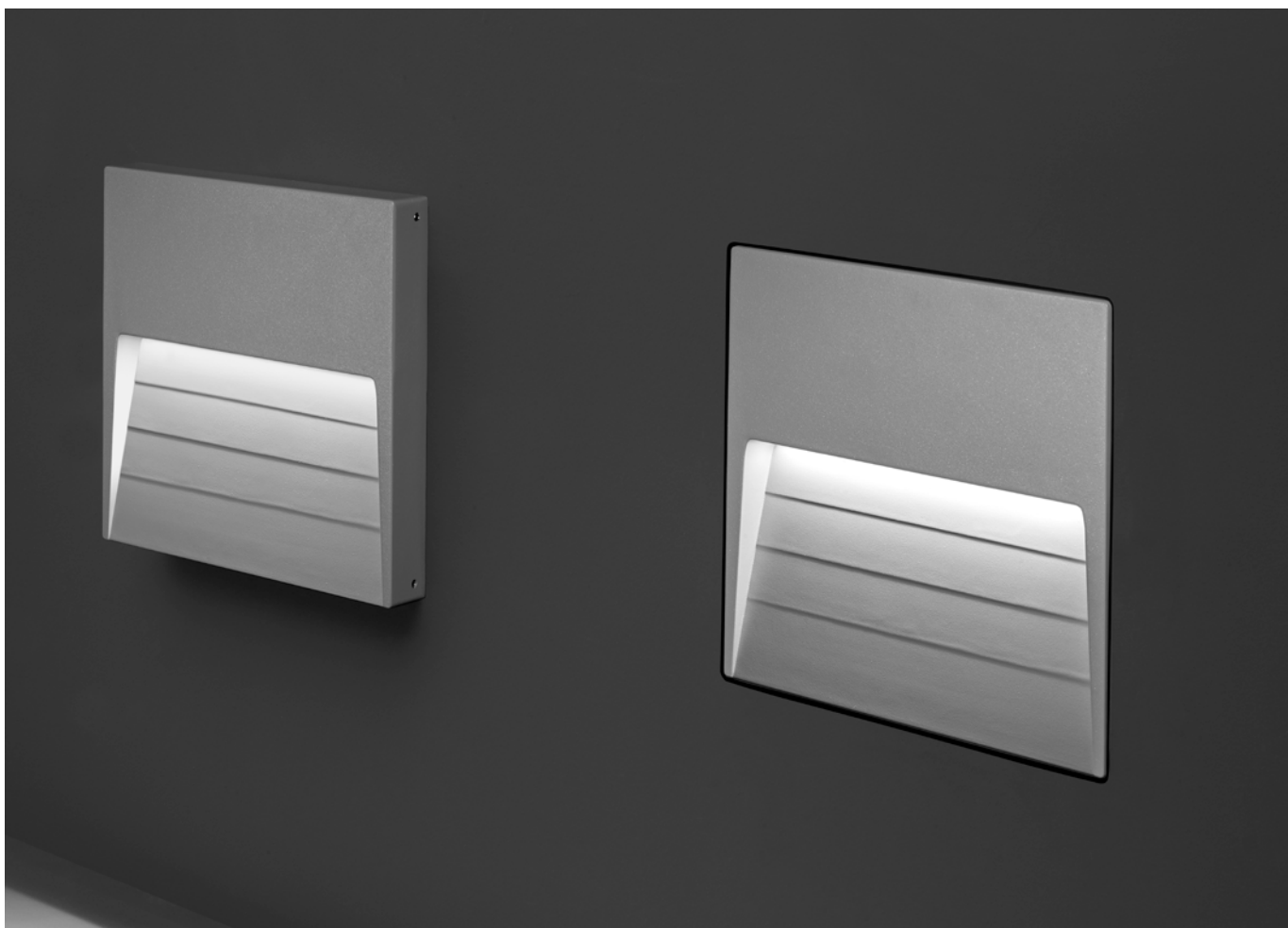

Surf Recess

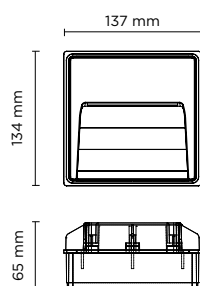

PRODUCT WEIGHT 0,70 kg



Code Example

504001 .27 .FW .01 .0

Surf Recess Mini

Square wall-recessed luminaire for outdoor installation, phospho-chromatised and polyester powder coated extruded copper-free aluminium body, tempered frosted glass diffuser, moulded silicone gaskets, polypropylene housing for recess. Built-in LED driver 220-240V 50-60Hz, with 6 CREE XH-G mid-power LED. IP65 rating.

504001
4W

CCT	Beam Angle	Im	Im/w	Finish	Dimming
.27 2700°K	.FW floor washer	333	83.25	.01 RAL 9006	.0 ON/OFF
.30 3000°K	.FW floor washer	350	87.50	.02 RAL 7016	
.40 4000°K	.FW floor washer	360	90.00	.03 Matt Black	

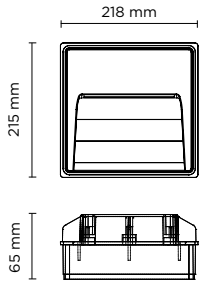

PRODUCT WEIGHT 1,50 kg



Surf Recess Medium

Code Example

504002.27.FW.01.0

Square wall-recessed luminaire for outdoor installation, phospho-chromatised and polyester powder coated extruded copper-free aluminium body, tempered frosted glass diffuser, moulded silicone gaskets, polypropylene housing for recess. Built-in LED driver 220-240V 50-60Hz, with 14 CREE XH-G mid-power LED. IP65 rating.

504002

8W

CCT	Beam Angle	lm	lm/w	Finish	Dimming
.27 2700°K	.FW floor washer	618	77.25	.01 RAL 9006	.0 ON/OFF
.30 3000°K	.FW floor washer	650	81.25	.02 RAL 7016	.D DALI
.40 4000°K	.FW floor washer	660	82.50	.03 Matt Black	

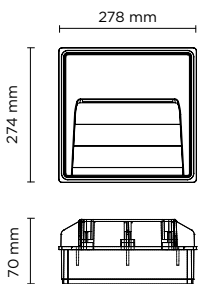

PRODUCT WEIGHT 2,10 kg



Surf Recess Maxi

Code Example

504003.27.FW.01.0

Square wall-recessed luminaire for outdoor installation, phospho-chromatised and polyester powder coated extruded copper-free aluminium body, tempered frosted glass diffuser, moulded silicone gaskets, polypropylene housing for recess. Built-in LED driver 220-240V 50-60Hz, with 21 CREE XH-G mid-power LED. IP65 rating.

504003

14W

CCT	Beam Angle	lm	lm/w	Finish	Dimming
.27 2700°K	.FW floor washer	950	67.86	.01 RAL 9006	.0 ON/OFF
.30 3000°K	.FW floor washer	1.000	71.42	.02 RAL 7016	.D DALI
.40 4000°K	.FW floor washer	1.020	72.86	.03 Matt Black	



Line Step

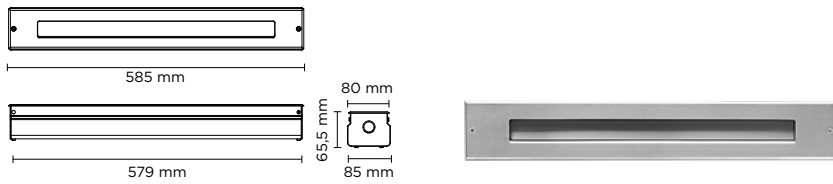

PRODUCT WEIGHT 4,00 kg



Line Step 01

Code Example

503001.30.AS.SS.O

Linear wall-recessed luminaire for outdoor installation, length 500mm, Phospho-chromatised and polyester powder coated extruded copper-free aluminium body and stainless steel AISI 304 frame, tempered frosted glass diffuser, moulded silicone gaskets, stainless steel recessing sleeve. Asymmetrical light distribution. Built-in LED driver 220-240V 50-60Hz, with 28 CREE XH-G mid-power LED. IP67 rating.

503001
17W

CCT	Beam Angle	lm	lm/w	Finish	Dimming
.30 3000°K	.AS 120°	1.000	58.82	.SS Stainless Steel	.0 ON/OFF .D DALI

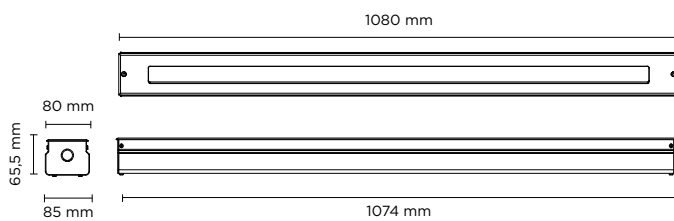

PRODUCT WEIGHT 7,00 kg

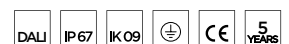

Line Step 02

Code Example

503002.30.AS.SS.O

Linear ground-recessed luminaire for outdoor installation, length 1.000mm, Phospho-chromatised and polyester powder coated extruded copper-free aluminium body and stainless steel AISI 304 frame, tempered frosted glass diffuser, moulded silicone gaskets, stainless steel recessing sleeve. Asymmetrical light distribution. Built-in LED driver 220-240V 50-60Hz, with 56 CREE XH-G mid-power LED. IP67 rating.

503002
34W

CCT	Beam Angle	lm	lm/w	Finish	Dimming
.30 3000°K	.AS 120°	2.000	58.82	.SS Stainless Steel	.0 ON/OFF .D DALI

BOL
LA
RDS





Boulevard Mini

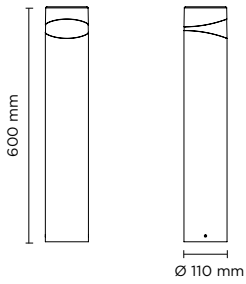

PRODUCT WEIGHT 4,00 kg



Boulevard mini 180

Code Example

601801.30.HA.01.0

600mm height bollard, round shape, for outdoor surface installation, 180° light emission, phospho-chromatised and polyester powder coated extruded copper-free aluminium body, polycarbonate diffuser, moulded silicone gasket and stainless steel screws. Anchorage bolts included. Built-in LED driver 220-240V 50-60Hz, with 8 CREE JK3030 mid-power LED. IP65 rating.

CCT	Beam Angle	lm	lm/w	Finish	Dimming
601801 6,5W	.30 3000°K	.HA 180°	400 61.53	.01 RAL 9006	.0 ON/OFF
	.40 4000°K	.HA 180°	410 63.08	.02 RAL 7016	.D DALI
				.03 Matt Black	.1 1-10V

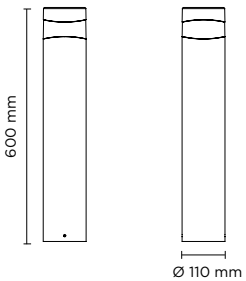

PRODUCT WEIGHT 4,00 kg



Boulevard mini 360

Code Example

601802.30.AL.01.0

600mm height bollard, round shape, for outdoor surface installation, 360° light emission, phospho-chromatised and polyester powder coated extruded copper-free aluminium body, polycarbonate diffuser, moulded silicone gasket and stainless steel screws. Anchorage bolts included. Built-in LED driver 220-240V 50-60Hz, with 16 CREE JK3030 mid-power LED. IP65 rating.

CCT	Beam Angle	lm	lm/w	Finish	Dimming
601802 12W	.30 3000°K	.AL 360°	800 66.66	.01 RAL 9006	.0 ON/OFF
	.40 4000°K	.AL 360°	820 68.33	.02 RAL 7016	.D DALI
				.03 Matt Black	.1 1-10V



Boulevard

MOMO Design

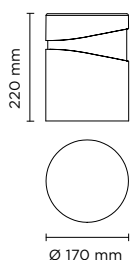

PRODUCT WEIGHT 4,00 kg



Code Example

609001.27.HA.01.0

Boulevard 01 180

220mm height bollard, round shape, for outdoor surface installation, 180° light emission, phosphochromatised and polyester powder coated die-cast copper-free aluminium body, polycarbonate diffuser, moulded silicone gasket and stainless steel screws. Anchorage bolts included. Built-in LED driver 220-240V 50-60Hz, with 12 CREE XH-G mid-power LED. IP65 rating.

	CCT*	Beam Angle	lm	lm/w	Finish	Dimming
609001	.27 2700°K	.HA 180°	760	84.44	.01 RAL 9006	.0 ON/OFF
9W	.30 3000°K	.HA 180°	800	88.88	.02 RAL 7016	.D DALI
					.03 Matt Black	.1 1-10V

*Other light colors available on request: Neutral-white

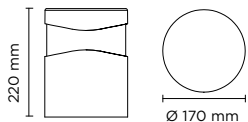

PRODUCT WEIGHT 4,20 kg



Boulevard 01 360

Code Example

609002.27.AL.01.0

220mm height bollard, round shape, for outdoor surface installation, 360° light emission, phospho-chromatised and polyester powder coated die-cast copper-free aluminium body, polycarbonate diffuser, moulded silicone gasket and stainless steel screws. Anchorage bolts included. Built-in LED driver 220-240V 50-60Hz, with 24 CREE XH-G mid-power LED. IP65 rating.

609002

18W

CCT*	Beam Angle	lm	lm/w	Finish	Dimming
.27 2700°K	.AL 360°	1520	84.44	.01 RAL 9006	.0 ON/OFF
.30 3000°K	.AL 360°	1.600	84.21	.02 RAL 7016	.D DALI
				.03 Matt Black	.1 1-10V

*Other light colors available on request: Neutral-white

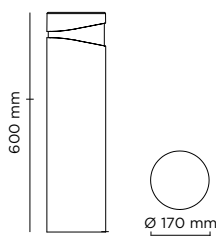

PRODUCT WEIGHT 5,50 kg



Boulevard 02 180

Code Example

609003.27.HA.01.0

600mm height bollard, round shape, for outdoor surface installation, 180° light emission, phospho-chromatised and polyester powder coated die-cast copper-free aluminium body, polycarbonate diffuser, moulded silicone gasket and stainless steel screws. Anchorage bolts included. Built-in LED driver 220-240V 50-60Hz, with 12 CREE XH-G mid-power LED. IP65 rating.

609003

9W

CCT*	Beam Angle	lm	lm/w	Finish	Dimming
.27 2700°K	.HA 180°	760	84.44	.01 RAL 9006	.0 ON/OFF
.30 3000°K	.HA 180°	800	88.88	.02 RAL 7016	.D DALI
				.03 Matt Black	.1 1-10V

*Other light colors available on request: Neutral-white

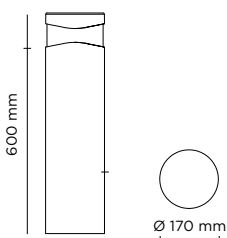

PRODUCT WEIGHT 5,70 kg



Boulevard 02 360

Code Example

609004.27.HA.01.0

600mm height bollard, round shape, for outdoor surface installation, 360° light emission, phospho-chromatised and polyester powder coated die-cast copper-free aluminium body, polycarbonate diffuser, moulded silicone gasket and stainless steel screws. Anchorage bolts included. Built-in LED driver 220-240V 50-60Hz, with 24 CREE XH-G mid-power LED. IP65 rating.

609004

18W

CCT*	Beam Angle	lm	lm/w	Finish	Dimming
.27 2700°K	.AL 360°	1520	84.44	.01 RAL 9006	.0 ON/OFF
.30 3000°K	.AL 360°	1600	84.21	.02 RAL 7016	.D DALI
				.03 Matt Black	.1 1-10V

*Other light colors available on request: Neutral-white

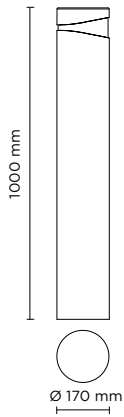

PRODUCT WEIGHT 7,00 kg



Code Example

609005 .27 .HA .01 .0

Boulevard 03 180

1000mm height bollard, round shape, for outdoor surface installation, 180° light emission, phosphochromatised and polyester powder coated die-cast copper-free aluminium body, polycarbonate diffuser, moulded silicone gasket and stainless steel screws. Anchorage bolts included. Built-in LED driver 220-240V 50-60Hz, with 12 CREE XH-G mid-power LED. IP65 rating.

609005

9W

CCT*	Beam Angle	lm	lm/w	Finish	Dimming
.27 2700°K	.HA 180°	760	84.44	.01 RAL 9006	.0 ON/OFF
.30 3000°K	.HA 180°	800	88.88	.02 RAL 7016	.D DALI
				.03 Matt Black	.1 1-10V

*Other light colors available on request: Neutral-white



PRODUCT WEIGHT 7,20 kg



Code Example

609006 .27 .HA .01 .0

Boulevard 03 360

1000mm height bollard, round shape, for outdoor surface installation, 360° light emission, phosphochromatised and polyester powder coated die-cast copper-free aluminium body, polycarbonate diffuser, moulded silicone gasket and stainless steel screws. Anchorage bolts included. Built-in LED driver 220-240V 50-60Hz, with 24 CREE XH-G mid-power LED. IP65 rating.

609006

18W

CCT*	Beam Angle	lm	lm/w	Finish	Dimming
.27 2700°K	.AL 360°	1520	84.44	.01 RAL 9006	.0 ON/OFF
.30 3000°K	.AL 360°	1.600	84.21	.02 RAL 7016	.D DALI
				.03 Matt Black	.1 1-10V

*Other light colors available on request: Neutral-white





Sector



PRODUCT WEIGHT 4,50 kg



Sector 380

Code Example

601701.30.90.01.0

Accessories p. 281

380mm height bollard, round shape, for outdoor surface installation, from 1 to 4 light windows, phospho-chromatised and polyester powder coated extruded copper-free aluminium body, opaline tempered glass, moulded silicone gasket and stainless steel screws. Built-in LED driver 220-240V 50-60Hz, with NR. 1 x CREE XHP70 LED. IP66 rating.

601701

6W

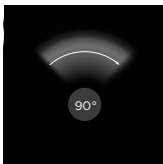

CCT	Beam Angle	lm	lm/w	Finish	Dimming
.30 3000°K	.90 90°	553	88.83	.01 RAL 9006	.0 ON/OFF
.40 4000°K	.90 90°	550	91.66	.02 RAL 7016	.D DALI
				.03 Matt Black	.1 1-10V

601702

12W

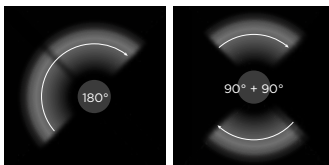

CCT	Beam Angle	lm	lm/w	Finish	Dimming
.30 3000°K	.HA 180°	1.067	88.92	.01 RAL 9006	.0 ON/OFF
	.HB 90°+90°	1.067	88.92		
.40 4000°K	.HA 180°	1.100	91.66	.02 RAL 7016	.D DALI
	.HB 90°+90°	1.100	91.66		
				.03 Matt Black	.1 1-10V

601703

18W

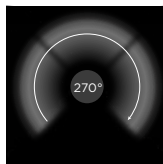

CCT	Beam Angle	lm	lm/w	Finish	Dimming
.30 3000°K	.HE 270°	1.600	88.88	.01 RAL 9006	.0 ON/OFF
.40 4000°K	.HE 270°	1.650	91.66		
				.02 RAL 7016	.D DALI
				.03 Matt Black	.1 1-10V

601704

24W



CCT	Beam Angle	lm	lm/w	Finish	Dimming
.30 3000°K	.AL 360°	2.134	88.91	.01 RAL 9006	.0 ON/OFF
.40 4000°K	.AL 360°	2.200	91.66		
				.02 RAL 7016	.D DALI
				.03 Matt Black	.1 1-10V



PRODUCT WEIGHT 6,00 kg



Code Example

601705.30.90.01.0

Accessories p. 281

Sector 650

650mm height bollard, round shape, for outdoor surface installation, from 1 to 4 light window, phospho-chromatised and polyester powder coated extruded copper-free aluminium body, opaline tempered glass, moulded silicone gasket and stainless steel screws. Built-in LED driver 220-240V 50-60Hz, with NR. 1 x CREE LED. IP66 rating.

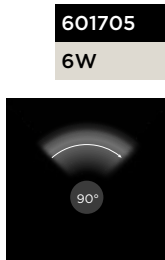

CCT	Beam Angle	lm	lm/w	Finish	Dimming
.30 3000°K	.90 90°	533	88.83	.01 RAL 9006	.0 ON/OFF
	.90 90°	550	91.66	.02 RAL 7016	.D DALI
.40 4000°K	.90 90°	550	91.66	.03 Matt Black	.1 1-10V



CCT	Beam Angle	lm	lm/w	Finish	Dimming
.30 3000°K	.HA 180°	1.067	88.92	.01 RAL 9006	.0 ON/OFF
	.HB 90°+90°	1.067	88.92	.02 RAL 7016	.D DALI
.40 4000°K	.HA 180°	1.100	91.66	.03 Matt Black	.1 1-10V
	.HB 90°+90°	1.100	91.66		

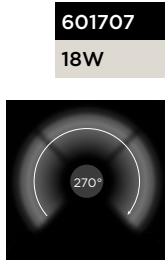

CCT	Beam Angle	lm	lm/w	Finish	Dimming
.30 3000°K	.HE 270°	1.600	88.88	.01 RAL 9006	.0 ON/OFF
	.HE 270°	1.650	91.66	.02 RAL 7016	.D DALI
.40 4000°K	.HE 270°	1.650	91.66	.03 Matt Black	.1 1-10V

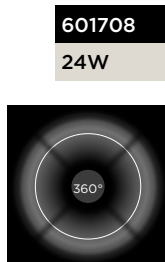

CCT	Beam Angle	lm	lm/w	Finish	Dimming
.30 3000°K	.AL 360°	2.134	88.91	.01 RAL 9006	.0 ON/OFF
	.AL 360°	2.200	91.66	.02 RAL 7016	.D DALI
.40 4000°K	.AL 360°	2.200	91.66	.03 Matt Black	.1 1-10V

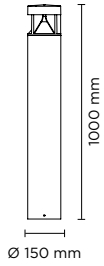

PRODUCT WEIGHT 8,00 kg



Code Example

601709.30.90.01.0

Accessories p. 281

Sector 1000

1.000mm height bollard, round shape, for outdoor surface installation, from 1 to 4 light window, phospho-chromatised and polyester powder coated extruded copper-free aluminium body, opaline tempered glass, moulded silicone gasket and stainless steel screws. Built-in LED driver 220-240V 50-60Hz, with NR. 1 x CREEXHP70 LED. IP66 rating.

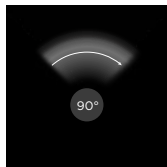

601709

6W

CCT	Beam Angle	lm	lm/w	Finish	Dimming
.30 3000°K	.90 90°	533	88.83	.01 RAL 9006	.0 ON/OFF
.40 4000°K	.90 90°	550	91.66	.02 RAL 7016	.D DALI
				.03 Matt Black	.1 1-10V

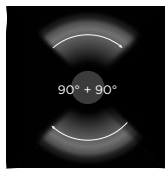
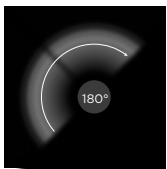

601710

12W

CCT	Beam Angle	lm	lm/w	Finish	Dimming
.30 3000°K	.HA 180°	1.067	88.92	.01 RAL 9006	.0 ON/OFF
	.HB 90°+90°	1.067	88.92	.02 RAL 7016	.D DALI
.40 4000°K	.HA 180°	1.100	91.66	.03 Matt Black	.1 1-10V
	.HB 90°+90°	1.100	91.66		

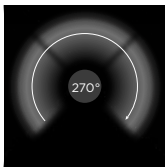

601711

18W

CCT	Beam Angle	lm	lm/w	Finish	Dimming
.30 3000°K	.HE 270°	1.600	88.88	.01 RAL 9006	.0 ON/OFF
.40 4000°K	.HE 270°	1.650	91.66	.02 RAL 7016	.D DALI
				.03 Matt Black	.1 1-10V

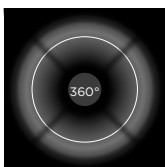

601712

24W

CCT	Beam Angle	lm	lm/w	Finish	Dimming
.30 3000°K	.AL 360°	2.134	88.91	.01 RAL 9006	.0 ON/OFF
.40 4000°K	.AL 360°	2.200	91.66	.02 RAL 7016	.D DALI
				.03 Matt Black	.1 1-10V

ACCESSORIES NOT INCLUDED

Accessories to be ordered separately.

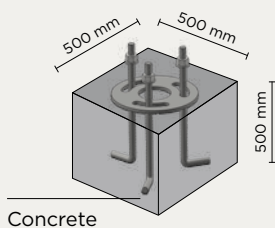

AC053

BASE PLATE

- Available for:
- SECTOR 380
 - SECTOR 650
 - SECTOR 1000



Promenade

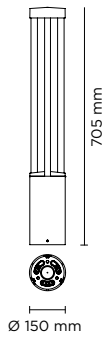

PRODUCT WEIGHT 6,50 kg



Code Example

601501.27.AL.01.0

Accessories p. 285

Promenade Round 01

705mm height bollard, round shape, for outdoor surface installation, 360° downward light emission, phospho-chromatised and polyester powder coated extruded aluminum body and die-cast aluminium cover. Polycarbonate Fresnel diffuser, moulded silicone gasket and stainless steel screws. Anchorage flange with threaded bolts included. Built-in LED driver 220-240V 50-60Hz, with 1 x COB CREE "CXB 1520" LED. IP66 rating.

CCT	Beam Angle	lm	lm/w	Finish	Dimming
601501 26W	.27 2700°K	.AL 360°	2.755 105.96	.01 RAL 9006	.0 ON/OFF
	.30 3000°K	.AL 360°	2.900 111.54	.02 RAL 7016	.D DALI
	.40 4000°K	.AL 360°	3.100 119.23	.03 Matt Black	.1 1-10V

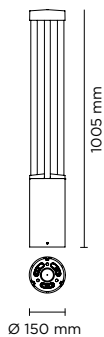

PRODUCT WEIGHT 7,00 kg



Code Example

601502.27.AL.01.0

Accessories p. 285

Promenade Round 02

1005mm height bollard, round shape, for outdoor surface installation, 360° downward light emission, phospho-chromatised and polyester powder coated extruded aluminum body and die-cast aluminium cover. Polycarbonate Fresnel diffuser, moulded silicone gasket and stainless steel screws. Anchorage flange with threaded bolts included. Built-in LED driver 220-240V 50-60Hz, with 1 x COB CREE "CXB 1520" LED. IP66 rating.

CCT	Beam Angle	lm	lm/w	Finish	Dimming
601502 26W	.27 2700°K	.AL 360°	2.755 105.96	.01 RAL 9006	.0 ON/OFF
	.30 3000°K	.AL 360°	2.900 111.54	.02 RAL 7016	.D DALI
	.40 4000°K	.AL 360°	3.100 119.23	.03 Matt Black	.1 1-10V

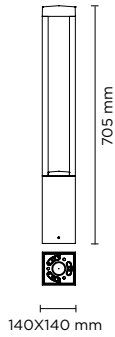

PRODUCT WEIGHT 6,80 kg



Code Example

601503.27.AL.01.0

Accessories p. 285

Promenade Square 01

705mm height bollard, square shape, for outdoor surface installation, 360° downward light emission, phospho-chromatised and polyester powder coated extruded aluminum body and die-cast aluminium cover. Polycarbonate Fresnel diffuser, moulded silicone gasket and stainless steel screws. Anchorage flange with threaded bolts included. Built-in LED driver 220-240V 50-60Hz, with 1 x COB CREE "CXB 1520" LED. IP66 rating.

601503
26W

CCT	Beam Angle	lm	lm/w	Finish	Dimming
.27 2700°K	.AL 360°	2.755	105.96	.01 RAL 9006	.0 ON/OFF
.30 3000°K	.AL 360°	2.900	111.54	.02 RAL 7016	.D DALI
.40 4000°K	.AL 360°	3.100	119.23	.03 Matt Black	.1 1-10V

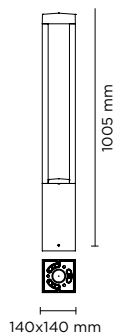

PRODUCT WEIGHT 7,30 kg



Code Example

601504.27.AL.01.0

Accessories p. 285

Promenade Square 02

1005mm height bollard, square shape, for outdoor surface installation, 360° downward light emission, phospho-chromatised and polyester powder coated extruded aluminum body and die-cast aluminium cover. Polycarbonate Fresnel diffuser, moulded silicone gasket and stainless steel screws. Anchorage flange with threaded bolts included. Built-in LED driver 220-240V 50-60Hz, with 1 x COB CREE "CXB 1520" LED. IP66 rating.

601504
26W

CCT	Beam Angle	lm	lm/w	Finish	Dimming
.27 2700°K	.AL 360°	2.755	105.96	.01 RAL 9006	.0 ON/OFF
.30 3000°K	.AL 360°	2.900	111.54	.02 RAL 7016	.D DALI
.40 4000°K	.AL 360°	3.100	119.23	.03 Matt Black	.1 1-10V



ACCESSORIES NOT INCLUDED

Accessories to be ordered separately.

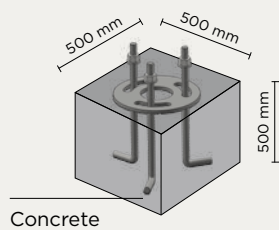

AC059

BASE PLATE

Available for:

- PROMENADE SQUARE 01
- PROMENADE SQUARE 02



Scout

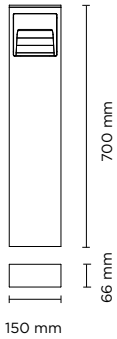

PRODUCT WEIGHT 4,50 kg



Code Example

601901 .27 .HA .01 .0

Scout Mini

700 mm height bollard, rectangular section, for outdoor surface installation, floor washer 180° light distribution, phospho-chromatised and polyester powder coated extruded copper-free aluminium body, frosted glass diffuser, moulded silicone gasket and stainless steel screws. Built-in LED driver 220-240V 50-60Hz, with 6 mid-power CREE XH-G LED. IP65 rating.

601901

4W

CCT	Beam Angle	lm	lm/w	Finish	Dimming
.27 2700°K	.HA 180°	333	83.25	.01 RAL 9006	.0 ON/OFF
.30 3000°K	.HA 180°	350	87.50	.02 RAL 7016	
.40 4000°K	.HA 180°	360	90.00	.03 Matt Black	



PRODUCT WEIGHT 7,00 kg



Code Example

601902 .27 .HA .01 .0

Scout Medium

750 mm height bollard, rectangular section, for outdoor surface installation, floor washer 180° light distribution, phospho-chromatised and polyester powder coated extruded copper-free aluminium body, frosted glass diffuser, moulded silicone gasket and stainless steel screws. Built-in LED driver 220-240V 50-60Hz, with 14 mid-power CREE XH-G LED. IP65 rating.

601902

8W

CCT	Beam Angle	lm	lm/w	Finish	Dimming
.27 2700°K	.HA 180°	618	77.25	.01 RAL 9006	.0 ON/OFF
.30 3000°K	.HA 180°	650	81.25	.02 RAL 7016	.D DALI
.40 4000°K	.HA 180°	665	83.13	.03 Matt Black	



Coiny Bollard

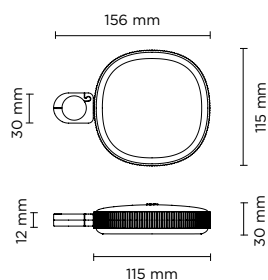

PRODUCT WEIGHT 1,20 kg



Coiny Bollard

Projector for outdoor installation on a façade/wall. Phospho-chromatised and polyester powder coated die-cast copper-free aluminium, tempered safety glass, moulded silicone gasket and stainless steel screws. With 1 direct 220-240V LUMENS "EDC 38C" COB LED. IP66 rating.

Code Example

602301, .27, .18, .01, 0

Accessories p. 289

602301
8W

CCT	Beam Angle	lm	lm/w	Finish	Dimming
.27 2700°K	.18 18°	380	47.50	.01 RAL 9006	.0 ON/OFF
	.36 36°	371	46.38	.02 RAL 7016	
	.60 60°	356	44.50	.03 Matt Black	
.30 3000°K	.18 18°	400	50.00		
	.36 36°	390	48.75		
	.60 60°	375	46.88		
.40 4000°K	.18 18°	410	51.25		
	.36 36°	400	50.00		
	.60 60°	385	48.13		

INTEGRATED ACCESSORIES

602301.27.18.01.0. --

Built-in accessories to be requested when ordering
example 602301.27.18.01.0.HC



.HC

HONEYCOMB LOUVER

A honeycomb structure designed to control the light beam, reduce glare, and prevent direct exposure to the light source.

ACCESSORIES NOT INCLUDED

Accessories to be ordered separately.



AC044

SPIKE

Ground-mounted installation accessory.



AC111

VISOR

Minimizes glare and optimizes beam direction for precise lighting.

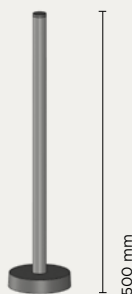

AC112

PIPE L 500 mm + BASE

Extension pipe length 500 mm made in anodized aluminum with phospho-chromatised and polyester powder coating; complete with fixing base.

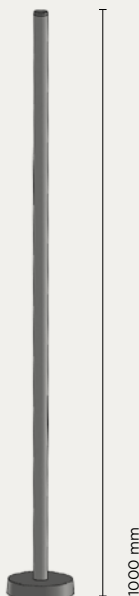

AC113

PIPE L 1000 mm + BASE

Extension pipe length 1.000 mm made in anodized aluminum with phospho-chromatised and polyester powder coating; complete with fixing base.



MAX NR. 2 FIXTURES PER PIPE







Tron

Nava + Arosio

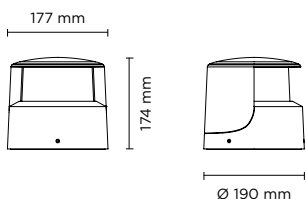

PRODUCT WEIGHT 4,00 kg



Code Example

602101 . 27 . HA . 01 . 0

Tron 180

Low height bollard, round shape, for outdoor surface installation, 180° downward light emission, phospho-chromatised and polyester powder coated die-cast aluminum body, ultra-resistant polycarbonate diffuser, moulded silicone gasket and stainless steel screws. Built-in LED driver 220-240V 50-60Hz, with 1 x COB CREE “CXB 1520” LED. IP66 rating.

CCT	Beam Angle	lm	lm/w	Finish	Dimming
602101 26W	.27 2700°K .HA 180°	1.045	40.20	.01 RAL 9006	.0 ON/OFF
	.30 3000°K .HA 180°	1.100	42.30	.02 RAL 7016	.D DALI
	.40 4000°K .HA 180°	1.150	44.23	.03 Matt Black	.1 1-10V

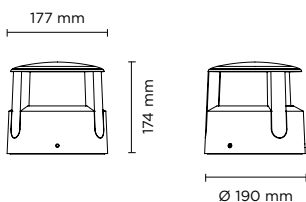

PRODUCT WEIGHT 4,00 kg



Code Example

602102 . 27 . AL . 01 . 0

Tron 360

Low height bollard, round shape, for outdoor surface installation, 360° downward light emission, phospho-chromatised and polyester powder coated die-cast aluminum body, ultra-resistant polycarbonate diffuser, moulded silicone gasket and stainless steel screws. Built-in LED driver 220-240V 50-60Hz, with 1 x COB CREE “CXB 1520” LED. IP66 rating.

CCT	Beam Angle	lm	lm/w	Finish	Dimming
602102 26W	.27 2700°K .AL 360°	1.948	74.92	.01 RAL 9006	.0 ON/OFF
	.30 3000°K .AL 360°	2.050	78.84	.02 RAL 7016	.D DALI
	.40 4000°K .AL 360°	2.100	80.77	.03 Matt Black	.1 1-10V



Periscope

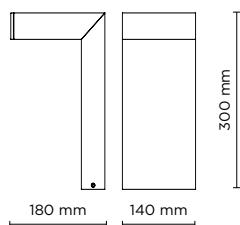

PRODUCT WEIGHT 3,50 kg



Code Example

601601.30.AS.01.0

Periscope 01

300mm height "L-shape" bollard, for outdoor installation, one-side downward asymmetrical light distribution, phospho-chromatised and polyester powder coated extruded aluminum body. Tempered safety glass, moulded silicone gasket and stainless steel screws. Built-in LED driver 220-240V 50-60Hz, with CREE "XP-G2" LED. IP65 rating.

	CCT	Beam Angle	lm	lm/w	Finish	Dimming
601601 7W	.30 3000°K	.AS	805	115.00	.01 RAL 9006	.0 ON/OFF
	.40 4000°K	.AS	847	121.00	.02 RAL 7016	.D DALI
					.03 Matt Black	.1 1-10V
601602 14W	.30 3000°K	.AS	1.610	115.00	.01 RAL 9006	.0 ON/OFF
	.40 4000°K	.AS	1.694	121.00	.02 RAL 7016	.D DALI
					.03 Matt Black	.1 1-10V

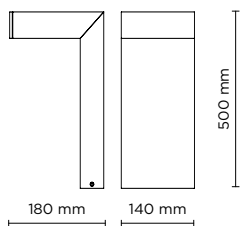

PRODUCT WEIGHT 4,50 kg



Periscope 02

Code Example

601603.30.AS.01.0

500mm height "L-shape" bollard, for outdoor installation, one-side downward asymmetrical light distribution, phospho-chromatised and polyester powder coated extruded aluminum body. Tempered safety glass, moulded silicone gasket and stainless steel screws. Built-in LED driver 220-240V 50-60Hz, with CREE "XP-G2" LED. IP65 rating.

	CCT	Beam Angle	lm	lm/w	Finish	Dimming
601603 7W	.30 3000°K	.AS	805	115.00	.01 RAL 9006	.0 ON/OFF
	.40 4000°K	.AS	847	121.00	.02 RAL 7016	.D DALI
					.03 Matt Black	.1 1-10V

	CCT	Beam Angle	lm	lm/w	Finish	Dimming
601604 14W	.30 3000°K	.AS	1.610	115.00	.01 RAL 9006	.0 ON/OFF
	.40 4000°K	.AS	1.694	121.00	.02 RAL 7016	.D DALI
					.03 Matt Black	.1 1-10V

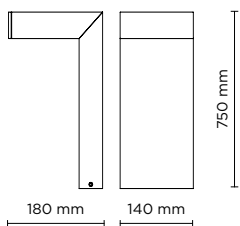

PRODUCT WEIGHT 5,50 kg



Periscope 03

Code Example

601605.30.AS.01.0

750mm height "L-shape" bollard, for outdoor installation, one-side downward asymmetrical light distribution, phospho-chromatised and polyester powder coated extruded aluminum body. Tempered safety glass, moulded silicone gasket and stainless steel screws. Built-in LED driver 220-240V 50-60Hz, with CREE "XP-G2" LED. IP65 rating.

	CCT	Beam Angle	lm	lm/w	Finish	Dimming
601605 7W	.30 3000°K	.AS	805	115.00	.01 RAL 9006	.0 ON/OFF
	.40 4000°K	.AS	847	121.00	.02 RAL 7016	.D DALI
					.03 Matt Black	.1 1-10V

	CCT	Beam Angle	lm	lm/w	Finish	Dimming
601606 14W	.30 3000°K	.AS	1.610	115.00	.01 RAL 9006	.0 ON/OFF
	.40 4000°K	.AS	1.694	121.00	.02 RAL 7016	.D DALI
					.03 Matt Black	.1 1-10V







Alder

Nava + Arosio

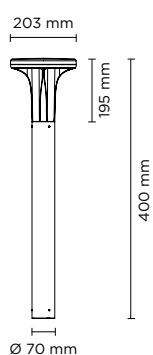

PRODUCT WEIGHT 3,00 kg



Code Example

602201.27.AL.01.0

Accessories p. 299

Alder 400

400mm height bollard, for outdoor installation, 360° light distribution, phospho-chromatised and polyester powder coated die-cast aluminum head and extruded pole. Tempered safety glass, moulded silicone gasket and stainless steel screws. Built-in LED driver 220-240V 50-60Hz, with 24 x CREE "XH-G" LED. IP66 rating.

602201
20W

CCT	Beam Angle	lm	lm/w	Finish	Dimming
.27 2700°K	.AL 360°	1.520	76.00	.01 RAL 9006	.0 ON/OFF
.30 3000°K	.AL 360°	1.600	80.00	.02 RAL 7016	.1 1-10V
.40 4000°K	.AL 360°	1.650	82.50	.03 Matt Black	.D DALI

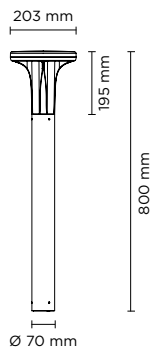

PRODUCT WEIGHT 4,30 kg



Code Example

602202, .27, .AL, .01, .0

Accessories p. 299

Alder 800

800mm height bollard, for outdoor installation, 360° light distribution, phospho-chromatised and polyester powder coated die-cast aluminum head and extruded pole. Tempered safety glass, moulded silicone gasket and stainless steel screws. Built-in LED driver 220-240V 50-60Hz, with 24 x CREE "XH-G" LED. IP66 rating.

	CCT	Beam Angle	lm	lm/w	Finish	Dimming
602202	.27 2700°K	.AL 360°	1.520	76.00	.01 RAL 9006	.0 ON/OFF
20W	.30 3000°K	.AL 360°	1.600	80.00	.02 RAL 7016	.1 1-10V
	.40 4000°K	.AL 360°	1.650	82.50	.03 Matt Black	.D DALI

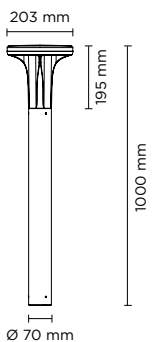

PRODUCT WEIGHT 4,80 kg



Code Example

602203, .27, .AL, .01, .0

Accessories p. 299

Alder 1000

1000mm height bollard, for outdoor installation, 360° light distribution, phospho-chromatised and polyester powder coated die-cast aluminum head and extruded pole. Tempered safety glass, moulded silicone gasket and stainless steel screws. Built-in LED driver 220-240V 50-60Hz, with 24 x CREE "XH-G" LED. IP66 rating.

	CCT	Beam Angle	lm	lm/w	Finish	Dimming
602203	.27 2700°K	.AL 360°	1.520	76.00	.01 RAL 9006	.0 ON/OFF
20W	.30 3000°K	.AL 360°	1.600	80.00	.02 RAL 7016	.1 1-10V
	.40 4000°K	.AL 360°	1.650	82.50	.03 Matt Black	.D DALI

ACCESSORIES NOT INCLUDED

Accessories to be ordered separately.



AC065

ANCHORAGE UNIT
Compatible for all products
of the series.





DO
WN
LIGH
TS

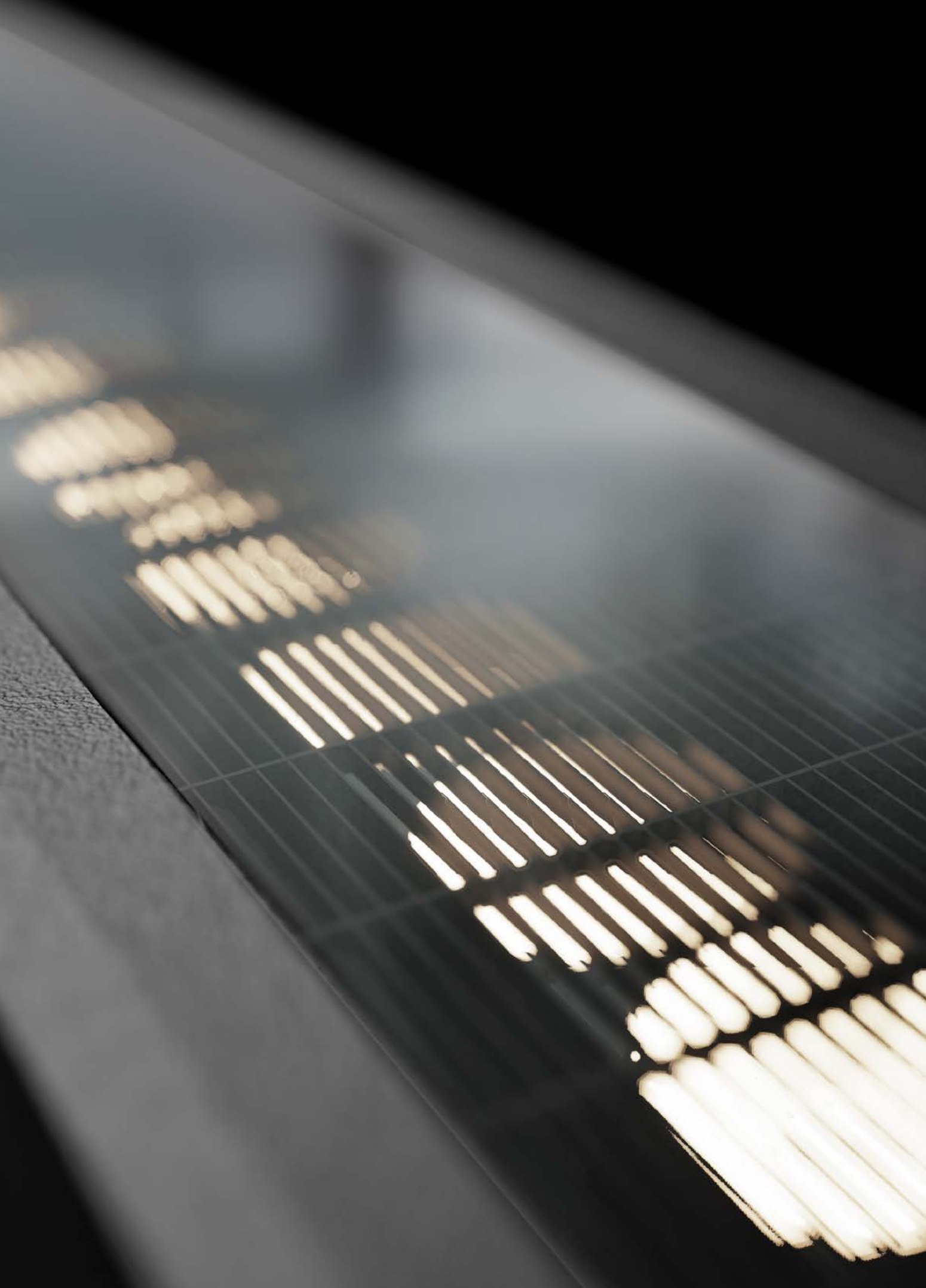



Nano Downlight

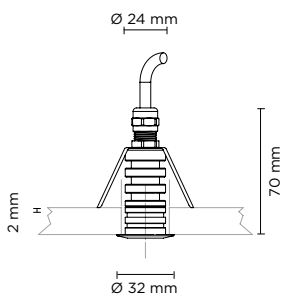

PRODUCT WEIGHT 0,20 kg



Code Example

709003.27.15.SS.0

Accessories p. 307

Nano XXS Downlight

Round ceiling-recessed luminaire for outdoor installation, hard anodized black aluminium body and stainless steel AISI 316 front trim, tempered safety glass, moulded silicone gasket. Remote constant current 350 mA driver needed, with 1 CREE XP-G2 LED. IP68 rating.

709003
1W

CCT	Beam Angle	Im	Im/w
.27 2700°K	.15 15°	71	71.00
	.30 30°	62	62.00
	.45 45°	57	57.00
.30 3000°K	.15 15°	75	75.00
	.30 30°	65	65.00
	.45 45°	60	60.00
.40 4000°K	.15 15°	80	80.00
	.30 30°	70	70.00
	.45 45°	65	65.00

Finish: **.SS** Stainless Steel
Dimming: **.0** ON/OFF

Remote Driver Selection

Brand	Manufacturer code	Type	Watt	IP Rate	Number of fixtures
ALVIT Italy	AL1435S-IP	constant current 350mA	14W	IP67	min 1 - max 8
Meanwell	LPC-20-350	constant current 350mA	16.8W	IP67	min 4 - max 12

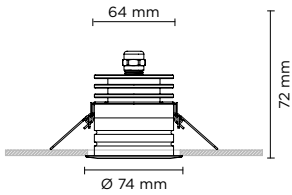

PRODUCT WEIGHT 0,60 kg



Nano XS Downlight

Code Example

709001.27.10.SS.0

Accessories p. 307

Round ceiling-recessed luminaire for outdoor installation, hard anodized black aluminium body and stainless steel AISI 316 front trim, tempered safety glass, moulded silicone gasket. Remote constant current max 700 mA driver needed, with 1 CREE XP-L LED. IP68 rating.

709001
Max 2,5W

CCT	Beam Angle	Finish	Dimming
.27 2700°K	.10 10°	.SS Stainless Steel	.0 ON/OFF
	.30 30°		
	.45 45°		
.30 3000°K	.10 10°		
	.30 30°		
	.45 45°		
.40 4000°K	.10 10°		
	.30 30°		
	.45 45°		

CCT	Beam Angle	350 mA LED POWER 1.2W		500 mA LED POWER 1.7W		700 mA LED POWER 2.5W	
		lm	lm/w	lm	lm/w	lm	lm/w
2700°K	10°	131	109.00	186	109.00	274	110.00
	30°	125	104.00	178	105.00	261	104.00
	45°	119	99.00	168	99.00	247	99.00
3000°K	10°	138	115.00	196	115.00	288	115.00
	30°	132	110.00	187	110.00	275	110.00
	45°	125	104.00	177	104.00	260	104.00
4000°K	10°	144	120.00	204	120.00	300	120.00
	30°	137	114.00	194	114.00	285	114.00
	45°	131	109.00	186	109.00	273	109.00

Remote Driver Selection

Brand	Manufacturer code	Type	Watt	IP Rate	Number of fixtures
ALVIT Italy	AL1435S-IP	constant current 350mA	14W	IP67	min 1 - max 8
ALVIT Italy	AL1450S-IP	constant current 500mA	14W	IP67	min 1 - max 6
ALVIT Italy	AL1470S-IP	constant current 700mA	14W	IP67	min 1 - max 4

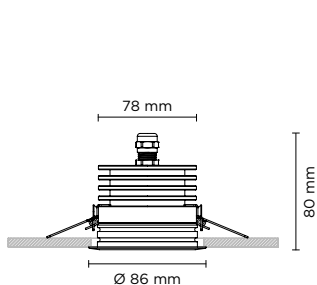

PRODUCT WEIGHT 0,80 kg



Code Example

709002.27.04.SS.0

Accessories p. 307

709002
Max 10W

Nano Downlight

Round ceiling-recessed luminaire for outdoor installation, hard anodized black aluminium body and stainless steel AISI 316 front trim, tempered safety glass, moulded silicone gasket. Remote constant current max 700 mA driver needed, with 1 CREE XHP35 HD LED. IP68 rating.

CCT	Beam Angle	Finish	Dimming
.27 2700°K	.04 4°	.SS Stainless Steel	.0 ON/OFF
	.10 10°		
	.28 28°		
	.55 55°		
.30 3000°K	.04 4°		
	.10 10°		
	.28 28°		
	.55 55°		
.40 4000°K	.04 4°		
	.10 10°		
	.28 28°		
	.55 55°		

CCT	Beam Angle	350 mA LED POWER 5W		500 mA LED POWER 7W		700 mA LED POWER 10W	
		lm	lm/w	lm	lm/w	lm	lm/w
2700°K	4°	484	97.00	655	93.57	862	86.20
	10°	465	93.00	629	89.86	828	82.84
	28°	450	90.00	610	87.14	804	80.40
	55°	383	77.00	519	74.14	683	68.30
3000°K	4°	510	102.00	690	98.57	907	90.69
	10°	489	97.80	662	94.57	872	87.20
	28°	474	94.80	642	91.71	846	84.60
	55°	403	80.58	546	77.95	719	71.91
4000°K	4°	520	104.00	703	100.43	930	93.00
	10°	499	99.80	676	96.57	890	89.00
	28°	484	96.80	656	93.71	863	86.30
	55°	411	82.28	558	82.71	734	73.36

Remote Driver Selection

Brand	Manufacturer code	Type	Watt	IP Rate	Number of fixtures
ALVIT Italy	AL1435S-IP	constant current 350mA	14W	IP67	min 1 – max 2
ALVIT Italy	AL1450S-IP	constant current 500mA	14W	IP67	1
ALVIT Italy	AL1470S-IP	constant current 700mA	14W	IP67	1
TCI Italy	152014/350	constant current 350mA	17W	IP68	min 1 – max 3
TCI Italy	152014/500	constant current 500mA	24W	IP68	min 1 – max 3
TCI Italy	152014/700	constant current 700mA	30W	IP68	min 1 – max 3



INTEGRATED ACCESSORIES

709003 . 27 . 14 . SS . 0 . --

Built-in accessories to be requested when ordering
example 709003.27.14.ss.0.HC



.HC

HONEYCOMB LOUVER

A honeycomb structure designed to control the light beam, reduce glare, and prevent direct exposure to the light source.

Compatible for all products of the series.



.GS

STANDARD GLARE SHIELD

Glare shield accessory made in hard anodized black aluminum, providing good balance in between glare control and light output.

Available for:

- **NANO XS DOWNLIGHT**
- **NANO DOWNLIGHT**



.SC

SUPER COMFORT GLARE SHIELD

Glare shield accessory made in hard anodized black aluminum, for applications requiring very reduced glaring; minimal light loss on the light surface but overall lumen output typically reduced by 50%.

Available for:

- **NANO XS DOWNLIGHT**
- **NANO DOWNLIGHT**



Nano Linear Downlight

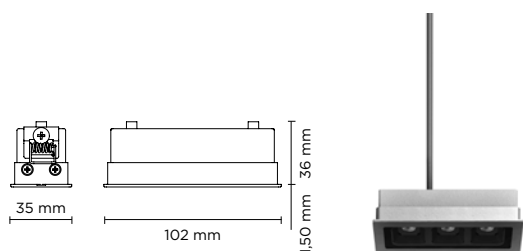

PRODUCT WEIGHT 0,50 kg



Code Example

701401.27.08.SS.0

Nano Linear Downlight HP

Linear shape ceiling-recessed luminaire for outdoor installation. Body in hard anodized aluminum with phospho-chromatised and polyester powder coating and frontal cover in stainless steel AISI 316L, tempered safety glass. Remote constant current max 700mA driver needed, with 3 CREE XP-G2 LED. IP68 rating.

701401
Max 6W

CCT	Beam Angle	Finish	Dimming
.27 2700°K	.08 8°	.SS Stainless Steel	.0 ON/OFF
	.32 32°		
	.45 45°		
.30 3000°K	.08 8°	.SS Stainless Steel	.0 ON/OFF
	.32 32°		
	.45 45°		
.40 4000°K	.08 8°	.SS Stainless Steel	.0 ON/OFF
	.32 32°		
	.45 45°		

CCT	Beam Angle	350 mA LED POWER 3W		500 mA LED POWER 4.5W		700 mA LED POWER 6W	
		lm	lm/w	lm	lm/w	lm	lm/w
2700°K	8°	300	100.00	378	83.75	538	89.70
	32°	287	95.80	360	80.25	512	85.33
	45°	278	92.80	350	77.75	501	83.60
3000°K	8°	306	102.00	387	86.25	546	90.69
	32°	293	97.80	373	82.75	522	87.20
	45°	284	94.80	360	80.25	507	84.60
4000°K	8°	312	104.00	396	87.88	558	93.00
	32°	300	99.80	380	84.50	534	89.00
	45°	290	96.80	369	82.00	518	86.30

Remote Driver Selection

Brand	Manufacturer code	Type	Watt	IP Rate	Number of fixtures
ALVIT Italy	AL1435S-IP	constant current 350mA	14W	IP67	min 1 - max 4
ALVIT Italy	AL1450S-IP	constant current 500mA	14W	IP67	min 1 - max 3
ALVIT Italy	AL1470S-IP	constant current 700mA	14W	IP67	min 1 - max 2
TCI Italy	152014/350	constant current 350mA	17W	IP68	min 1 - max 5
TCI Italy	152014/500	constant current 500mA	24W	IP68	min 1 - max 5
TCI Italy	152014/700	constant current 700mA	30W	IP68	min 1 - max 4

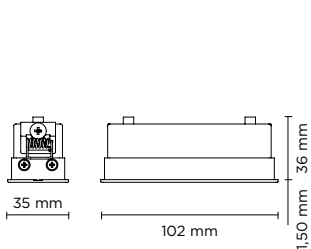

PRODUCT WEIGHT 0,50 kg



Nano Linear Downlight Wall-washer

Linear shape ceiling-recessed luminaire for outdoor installation. Body in hard anodized aluminum with phospho-chromatised and polyester powder coating and frontal cover in stainless steel AISI 316L, tempered safety glass. Remote constant current 500mA driver needed, with 16 x mid-power SAMSUNG 2835 LED. IP68 rating.

Code Example

701402.27.WW.SS.0

701402

6W

CCT	Beam Angle	Finish	Dimming	lm	lm/w
.27 2700°K	.WW wall washer	.SS Stainless Steel	.0 ON/OFF	450	75.00
.30 3000°K	.WW wall washer			470	78.34
.40 4000°K	.WW wall washer			490	81.67

Remote Driver Selection

Brand	Manufacturer code	Type	Watt	IP Rate	Number of fixtures
ALVIT Italy	AL1450S-IP	constant current 500mA	14W	IP67	min 1 - max 2
TCI Italy	152014/500	constant current 500mA	24W	IP68	min 1 - max 3

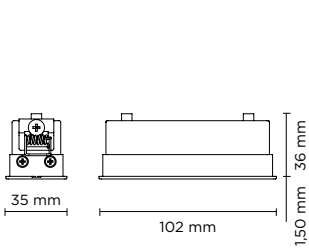

PRODUCT WEIGHT 0,50 kg



Nano Linear Downlight Blade

Code Example

701403.**27**.**BL**.**SS**.**0**

Linear shape ceiling-recessed luminaire for outdoor installation. Body in hard anodized aluminum with phospho-chromatised and polyester powder coating and frontal cover in stainless steel AISI 316L, tempered safety glass. Remote constant current max 700mA driver needed, with 3 CREE XP-G2 LED. IP68 rating

701403
Max 6W

CCT	Beam Angle	Finish	Dimming
.27 2700°K	.BL 20°x100°	.SS Stainless Steel	.0 ON/OFF
.30 3000°K	.BL 20°x100°		
.40 4000°K	.BL 20°x100°		

CCT	Beam Angle	350 mA LED POWER 3W		500 mA LED POWER 4.5W		700 mA LED POWER 6W	
		lm	lm/w	lm	lm/w	lm	lm/w
2700°K	20°x100°	210	70.00	315	70.00	420	70.00
3000°K	20°x100°	220	73.33	330	73.33	440	73.33
4000°K	20°x100°	230	76.66	345	76.66	460	76.66

Remote Driver Selection

Brand	Manufacturer code	Type	Watt	IP Rate	Number of fixtures
ALVIT Italy	AL1435S-IP	constant current 350mA	14W	IP67	min 1 - max 4
ALVIT Italy	AL1450S-IP	constant current 500mA	14W	IP67	min 1 - max 3
ALVIT Italy	AL1470S-IP	constant current 700mA	14W	IP67	min 1 - max 2
TCI Italy	152014/350	constant current 350mA	17W	IP68	min 1 - max 5
TCI Italy	152014/500	constant current 500mA	24W	IP68	min 1 - max 5
TCI Italy	152014/700	constant current 700mA	30W	IP68	min 1 - max 4

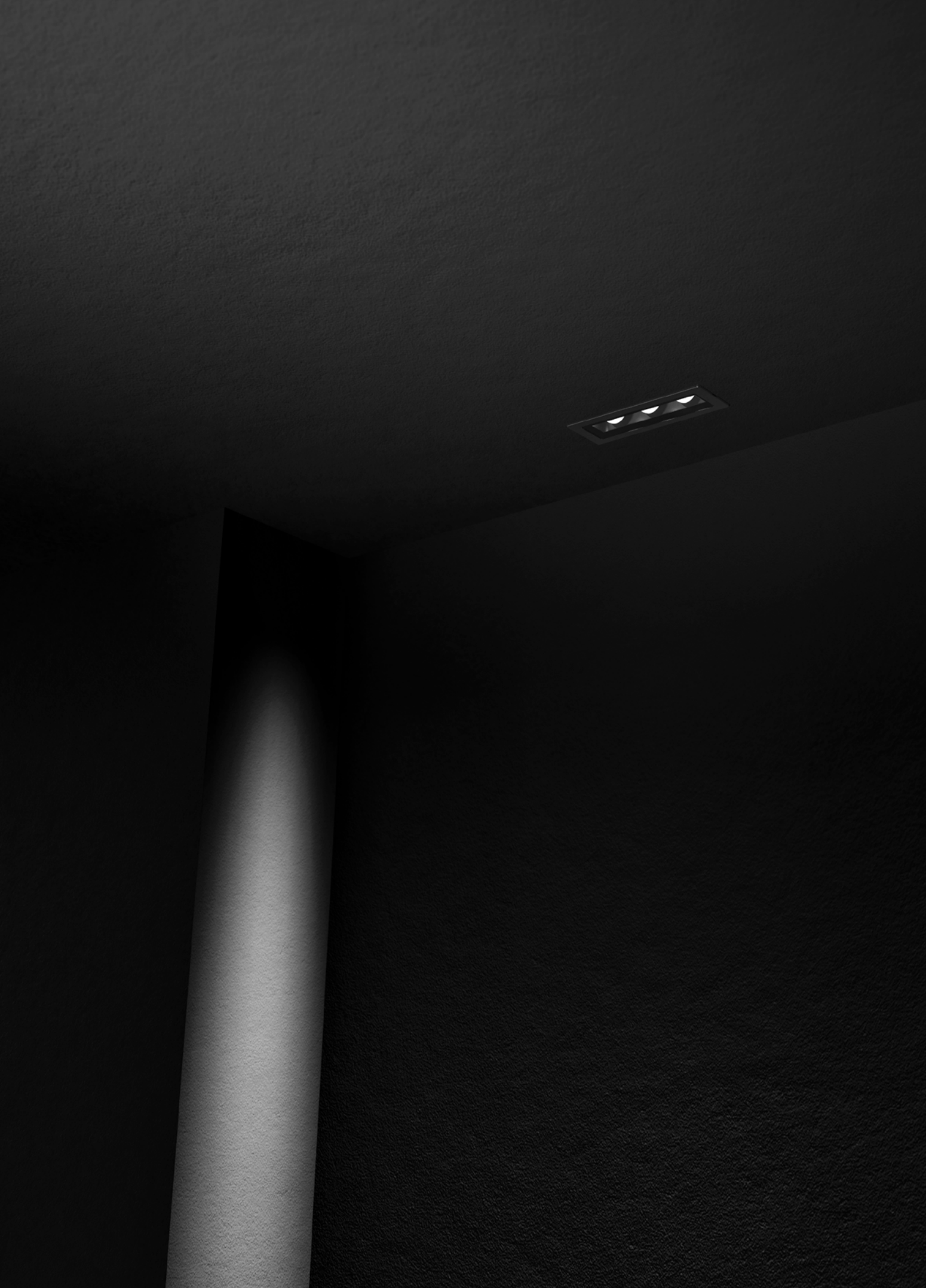



Tag 03

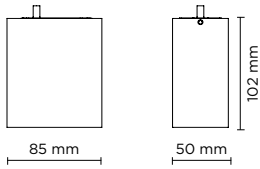

PRODUCT WEIGHT 0,80 kg



Tag Mini 03

Code Example

708001, .30, .18, .01, 0

Downlight luminaire to be surface mounted on a ceiling, with downward light distribution. Luminaire body is made of extruded copper-free aluminum, secured with die-cast aluminum base, tempered safety glass, moulded silicone gasket and stainless steel screws. Built-in LED driver 220-240V 50-60Hz, with nr. 2 CREE XP-G2 LED. IP65 rating.

CCT	Beam Angle	Im	Im/w	Finish	Dimming
708001 4.5W	.30 3000°K	.18 18°	280 62.22	.01 RAL 9006	.0 ON/OFF
	3000°K	.36 36°	270 60.00	.02 RAL 7016	
.40 4000°K	.18 18°	308 68.44		.03 Matt Black	
	4000°K	.36 36°	292 64.88		

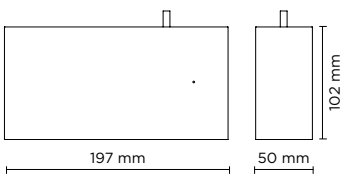

PRODUCT WEIGHT 1,50 kg



Tag Medium 03

Code Example

708002, .30, .18, .01, 0

Downlight luminaire to be surface mounted on a ceiling, with downward light distribution. Luminaire body is made of extruded copper-free aluminum, secured with die-cast aluminum base, tempered safety glass, moulded silicone gasket and stainless steel screws. Built-in LED driver 220-240V 50-60Hz, with nr. 6 CREE XP-G2 LED. IP65 rating.

CCT	Beam Angle	Im	Im/w	Finish	Dimming
708002 8W	.30 3000°K	.18 18°	840 105.00	.01 RAL 9006	.0 ON/OFF
	3000°K	.36 36°	810 101.25	.02 RAL 7016	.D DALI
.40 4000°K	.18 18°	924 115.50		.03 Matt Black	
	4000°K	.36 36°	876 109.50		



Cielo

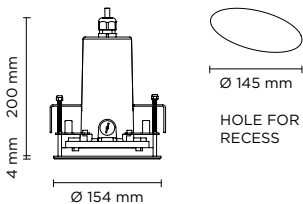

PRODUCT WEIGHT 2,40 kg



Code Example

701301.27.18.SS.O

Accessories p. 321

Cielo Mini Cob

Diameter 154mm ceiling-recessed luminaire for outdoor installation, phospho-chromatised and polyester powder coated die-cast copper-free aluminium body and stainless steel AISI 316L frame, tempered safety glass, moulded silicone gasket. Light source tilt system +/- 15deg from outside. Built-in LED driver 220-240V 50-60Hz, with 1 CREE CXB1304 LED. IP67 rating.

701301

8W

CCT	Beam Angle	lm	lm/w	Finish	Dimming
.27 2700°K	.18 18°	600	75.00	.SS Stainless Steel	.O ON/OFF .D DALI
	.36 36°	580	72.50		
	.60 60°	560	70.00		
.30 3000°K	.18 18°	620	77.50	.SS Stainless Steel	.O ON/OFF .D DALI
	.36 36°	600	75.00		
	.60 60°	580	72.50		
.40 4000°K	.18 18°	640	80.00	.SS Stainless Steel	.O ON/OFF .D DALI
	.36 36°	620	77.50		
	.60 60°	600	75.00		

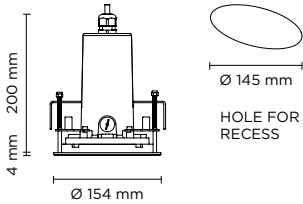

PRODUCT WEIGHT 2,40 kg



Code Example

701302.27.04.SS.0

Accessories p. 321

Cielo Mini HP

Diameter 154mm ceiling-recessed luminaire for outdoor installation, phospho-chromatised and polyester powder coated die-cast copper-free aluminium body and stainless steel AISI 316L frame, tempered safety glass, moulded silicone gasket. Light source tilt system +/- 15deg from outside. Built-in LED driver 220-240V 50-60Hz, with 1 CREE "XHP35" LED. IP67 rating.

701302

8W

CCT	Beam Angle	lm	lm/w	Finish	Dimming
.27 2700°K	.04 4°	670	83.75	.SS Stainless Steel	.0 ON/OFF
	.10 10°	642	80.25		
	.28 28°	622	77.75		
	.55 55°	563	65.92		
.30 3000°K	.04 4°	690	86.25	.SS Stainless Steel	.0 ON/OFF
	.10 10°	662	82.75		
	.28 28°	642	80.25		
	.55 55°	546	68.21		
.40 4000°K	.04 4°	703	87.88	.SS Stainless Steel	.0 ON/OFF
	.10 10°	676	84.50		
	.28 28°	656	82.00		
	.55 55°	558	69.70		

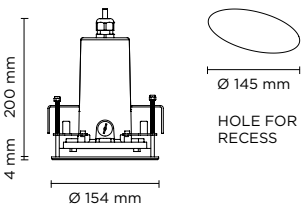

PRODUCT WEIGHT 2,40 kg



Code Example

701303.RW.12.SS.X

Accessories p. 321

Cielo Mini HP DMX RGBW

Diameter 154mm ceiling-recessed luminaire for outdoor installation, phospho-chromatised and polyester powder coated die-cast copper-free aluminium body and stainless steel AISI 316L frame, tempered safety glass, moulded silicone gasket. Light source tilt system +/- 15deg from outside. Remote 24V DC power supply needed, DMX interface integrated; with 1 x CREE "XML" RGBW LED. IP67 rating.

701303

4,5W

CCT	Beam Angle	lm	lm/w	Finish	Dimming
.RW RGBW	.12 12°	160	35.55	.SS Stainless Steel	.X DMX
	.25 25°	152	33.78		
	.35 35°	145	32.23		.D DALI

Remote Driver Selection

Brand	Manufacturer code	Type	Watt	IP Rate	Number of fixtures
Meanwell	LPV-20-24	constant voltage 24V DC	20W	IP67	min 1 - max 3
Meanwell	LPV-35-24	constant voltage 24V DC	35W	IP67	min 1 - max 6

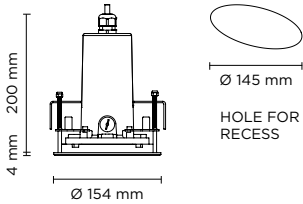

PRODUCT WEIGHT 2,40 kg



Code Example

701304.27.DF.SS.O

Accessories p. 321

Cielo Mini Diffused

Diameter 154mm ceiling-recessed luminaire for outdoor installation, phospho-chromatised and polyester powder coated die-cast copper-free aluminium body and stainless steel AISI 316L frame, tempered safety glass, moulded silicone gasket. Built-in LED driver 220-240V 50-60Hz, with 16 x mid-power SAMSUNG 2835 LED. IP67 rating.

701304

6W

CCT	Beam Angle	Im	Im/w
.27 2700°K	.DF diffused	100	16.67
.30 3000°K	.DF diffused	110	18.34
.40 4000°K	.DF diffused	120	20.00

Finish

.SS Stainless Steel

Dimming

.O ON/OFF

.D DALI

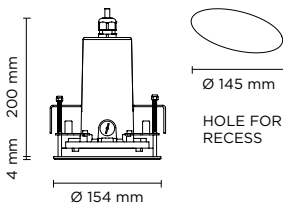

PRODUCT WEIGHT 2,40 kg

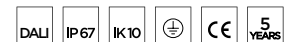

Code Example

701305.27.WW.SS.O

Accessories p. 321

Cielo Mini Wall-washer

Diameter 154mm ceiling-recessed luminaire for outdoor installation, phospho-chromatised and polyester powder coated die-cast copper-free aluminium body and stainless steel AISI 316L frame, tempered safety glass, moulded silicone gasket. Built-in LED driver 220-240V 50-60Hz, with 16 x mid-power SAMSUNG 2835 LED. IP67 rating.

701305

6W

CCT	Beam Angle	Im	Im/w
.27 2700°K	.WW wall washer	450	75.00
.30 3000°K	.WW wall washer	470	78.34
.40 4000°K	.WW wall washer	490	81.67

Finish

.SS Stainless Steel

Dimming

.O ON/OFF

.D DALI

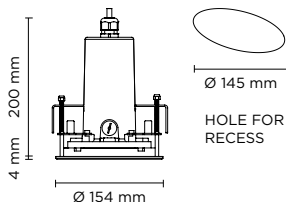

PRODUCT WEIGHT 2,40 kg



Code Example

701306.27.BL.SS.O

Accessories p. 321

Cielo Mini Blade

Diameter 154mm ceiling-recessed luminaire for outdoor installation, phospho-chromatised and polyester powder coated die-cast copper-free aluminium body and stainless steel AISI 316L frame, tempered safety glass, moulded silicone gasket. Built-in LED driver 220-240V 50-60Hz, with 1 CREE "XHP35" LED. IP67 rating.

701306

8W

CCT	Beam Angle	lm	lm/w
.27 2700°K	.BL 8°x170°	560	70.00
.30 3000°K	.BL 8°x170°	582	72.75
.40 4000°K	.BL 8°x170°	600	75.00

Finish

.SS Stainless Steel

Dimming

.O ON/OFF

.D DALI

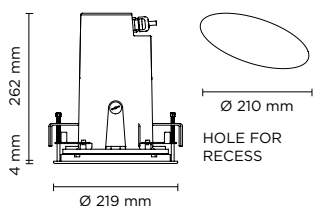

PRODUCT WEIGHT 4,70 kg



Code Example

701307.27.14.SS.O

Accessories p. 321

Cielo Medium Cob

Diameter 219mm ceiling-recessed luminaire for outdoor installation, phospho-chromatised and polyester powder coated die-cast copper-free aluminium body and stainless steel AISI 316L frame, tempered safety glass, moulded silicone gasket. Light source tilt system +/- 15deg from outside. Built-in LED driver 220-240V 50-60Hz, with 1 CREE CXB1512 LED. IP67 rating.

701307

13W

CCT	Beam Angle	lm	lm/w
.27 2700°K	.14 14°	1.050	80.77
	.35 35°	1.000	76.93
	.55 55°	980	75.38
.30 3000°K	.14 14°	1.099	84.54
	.35 35°	1.079	83.00
	.55 55°	1.057	81.31
.40 4000°K	.14 14°	1.133	87.15
	.35 35°	1.113	85.62
	.55 55°	1.090	83.85

Finish

.SS Stainless Steel

Dimming

.O ON/OFF

.D DALI

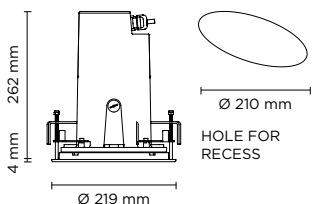

PRODUCT WEIGHT 4,70 kg



Code Example

701308.27.04.SS.0

Accessories p. 321

Cielo Medium HP

Diameter 219mm ceiling-recessed luminaire for outdoor installation, phospho-chromatised and polyester powder coated die-cast copper-free aluminium body and stainless steel AISI 316L frame, tempered safety glass, moulded silicone gasket. Light source tilt system +/- 15deg from outside. Built-in LED driver, with 3 x CREE "XHP35" LED. IP67 rating.

701308
20W

CCT	Beam Angle	lm	lm/w
.27 2700°K	.04 4°	1.809	90.45
	.10 10°	1.733	86.65
	.28 28°	1.679	83.95
	.55 55°	1.427	71.36
.30 3000°K	.04 4°	1.863	93.15
	.10 10°	1.787	89.35
	.28 28°	1.733	86.65
	.55 55°	1.473	73.65
.40 4000°K	.04 4°	1.898	94.90
	.10 10°	1.825	91.25
	.28 28°	1.771	88.55
	.55 55°	1.505	75.27

Finish	Dimming
.SS Stainless Steel	.0 ON/OFF
	.D DALI

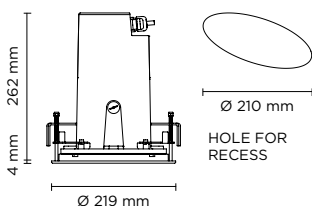

PRODUCT WEIGHT 4,70 kg



Code Example

701309.RW.12.SS.X

Accessories p. 321

Cielo Medium HP DMX RGBW

Diameter 219mm ceiling-recessed luminaire for outdoor installation, phospho-chromatised and polyester powder coated die-cast copper-free aluminium body and stainless steel AISI 316L frame, tempered safety glass, moulded silicone gasket. Light source tilt system +/- 15deg from outside. Built-in LED driver, DMX interface integrated; with 3 x CREE "XML" RGBW LED. IP67 rating.

701309
14W

CCT	Beam Angle	lm	lm/w
.RW RW RGBW	.12 12°	480	34.28
	.25 25°	456	32.58
	.35 35°	435	31.07

Finish	Dimming
.SS Stainless Steel	.X DMX
	.D DALI

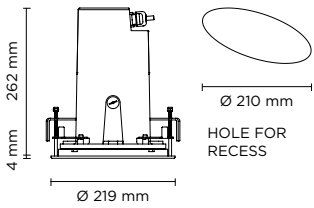

PRODUCT WEIGHT 4,70 kg

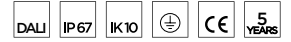

Code Example

701310.27.WW.SS.0

Accessories p. 321

Cielo Medium Wall-washer

Diameter 219mm ceiling-recessed luminaire for outdoor installation, phospho-chromatised and polyester powder coated die-cast copper-free aluminium body and stainless steel AISI 316L frame, tempered safety glass, moulded silicone gasket. Built-in LED driver 220-240V 50-60Hz, with 32 x mid-power SAMSUNG 2835 LED. IP67 rating.

701310

13W

CCT	Beam Angle	Im	lm/w
.27 2700°K	.WW Wall Washer	900	69.23
.30 3000°K	.WW Wall Washer	940	72.31
.40 4000°K	.WW Wall Washer	980	75.38

Finish

.SS Stainless Steel

Dimming

.0 ON/OFF

.D DALI

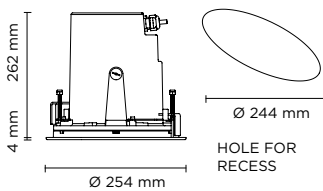

PRODUCT WEIGHT 5,70 kg



Code Example

701311.27.14.SS.0

Accessories p. 321

Cielo Maxi Cob

Diameter 254mm ceiling-recessed luminaire for outdoor installation, phospho-chromatised and polyester powder coated die-cast copper-free aluminium body and stainless steel AISI 316L frame, tempered safety glass, moulded silicone gasket. Light source tilt system +/- 15deg from outside. Built-in LED driver 220-240V 50-60Hz, with 1 CREE CXB2540 LED. IP67 rating.

701311

32W

CCT	Beam Angle	Im	lm/w
.27 2700°K	.14 14°	2.960	92.50
	.35 35°	2.940	91.88
	.55 55°	2.920	91.25
.30 3000°K	.14 14°	2.970	92.81
	.35 35°	2.950	92.19
	.55 55°	2.930	91.56
.40 4000°K	.14 14°	2.990	93.44
	.35 35°	2.970	92.81
	.55 55°	2.950	92.19

Finish

.SS Stainless Steel

Dimming

.0 ON/OFF

.D DALI

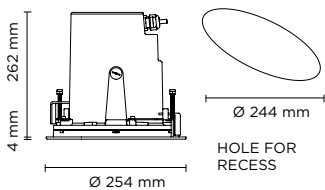

PRODUCT WEIGHT 5,70 kg



Code Example

701312 .27 .04 .SS .0

Accessories p. 321

Cielo Maxi HP

Diameter 254mm ceiling-recessed luminaire for outdoor installation, phospho-chromatised and polyester powder coated die-cast copper-free aluminium body and stainless steel AISI 316L frame, tempered safety glass, moulded silicone gasket. Light source tilt system +/- 15deg from outside. Built-in LED driver, with 4 x CREE "XHP50.2" LED. IP67 rating.

701312

34W

CCT	Beam Angle	lm	lm/w
.27 2700°K	.04 4°	3.296	96.94
	.10 10°	3.268	96.12
	.28 28°	3.239	95.26
	.55 55°	2.753	80.97
.30 3000°K	.04 4°	3.325	97.79
	.10 10°	3.296	96.94
	.28 28°	3.268	96.12
	.55 55°	2.778	81.70
.40 4000°K	.04 4°	3.353	98.62
	.10 10°	3.325	97.79
	.28 28°	3.296	96.94
	.55 55°	2.802	82.40

Finish

.SS Stainless Steel

Dimming

.0 ON/OFF

.D DALI

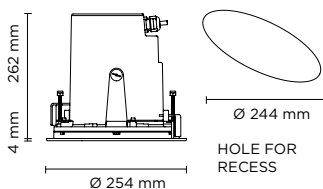

PRODUCT WEIGHT 5,70 kg



Code Example

701313 .RW .12 .SS .X

Accessories p. 321

Cielo Maxi HP DMX RGBW

Diameter 254mm ceiling-recessed luminaire for outdoor installation, phospho-chromatised and polyester powder coated die-cast copper-free aluminium body and stainless steel AISI 316L frame, tempered safety glass, moulded silicone gasket. Light source tilt system +/- 15deg from outside. Built-in LED driver, DMX interface integrated; with 6 x CREE "XML" RGBW LED. IP67 rating.

701313

28W

CCT	Beam Angle	lm	lm/w
.RW RGBW	.12 12°	1.000	35.71
.RW RGBW	.25 25°	992	35.43
.RW RGBW	.35 35°	981	35.04

Finish

.SS Stainless Steel

Dimming

.X DMX

.D DALI

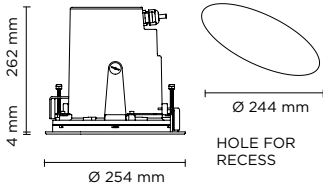

PRODUCT WEIGHT 5,70 kg

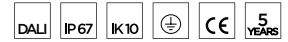

Cielo Maxi Wall-washer

Diameter 254mm ceiling-recessed luminaire for outdoor installation, phospho-chromatised and polyester powder coated die-cast copper-free aluminium body and stainless steel AISI 316L frame, tempered safety glass, moulded silicone gasket. Built-in LED driver 220-240V 50-60Hz, with 66 x mid-power SAMSUNG 2835 LED. IP67 rating.

Code Example

701314.27.WW.SS.O

Accessories p. 321

	CCT	Beam Angle	lm	lm/w	Finish	Dimming
701314	.27 2700°K	.WW wall washer	1800	75.00	.SS Stainless Steel	.O ON/OFF
24W	.30 3000°K	.WW wall washer	1880	78.33		.D DALI
	.40 4000°K	.WW wall washer	1960	81.67		

INTEGRATED ACCESSORIES

701301.27.18.SS.O

Built-in accessories to be requested when ordering example 701301.27.18.SS.O.HC



.HC

HONEYCOMB

A honeycomb structure designed to control the light beam, reduce glare, and prevent direct exposure to the light source.

Available for:

- CIELO MINI COB
- CIELO MINI HP
- CIELO MINI HP DMX RGBW
- CIELO MEDIUM COB
- CIELO MEDIUM HP
- CIELO MEDIUM HP DMX RGBW
- CIELO MAXI COB
- CIELO MAXI HP
- CIELO MAXI HP DMX RGBW



.GS

GLARE SHIELD

Glare shield accessory made in hard anodized black aluminum, for applications requiring very reduced glaring; minimal light loss on the light surface but overall lumen output typically reduced by 50%.

Available for:

- CIELO MINI COB
- CIELO MINI HP
- CIELO MINI HP DMX RGBW



Qubo Downlight

Nava + Arosio

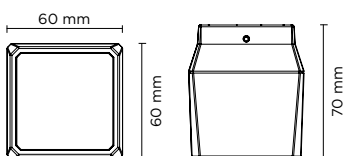

PRODUCT WEIGHT 0,70 kg



Code Example

701101 .27 .04 .01 .0

Accessories p. 326

Qubo Micro HP Downlight

Surface mounted luminaire for outdoor ceiling installation. Phospho-chromatised and polyester powder coated die-cast copper-free aluminium base and head, tempered safety glass, moulded silicone gaskets, with screws in stainless steel.

Remote 24V DC power supply needed, with 1 x CREE "XHP35" LED. IP66 rating.

701101
6W

CCT	Beam Angle	lm	lm/w	Finish	Dimming
.27 2700°K	.04 4°	484	80.67	.01 RAL 9006	.0 ON/OFF
	.10 10°	465	77.50	.02 RAL 7016	
	.28 28°	450	75.00	.03 Matt Black	
	.55 55°	383	63.83		
.30 3000°K	.04 4°	510	85.00		
	.10 10°	489	81.50		
	.28 28°	474	79.00		
	.55 55°	403	67.15		
.40 4000°K	.04 4°	520	86.67		
	.10 10°	499	83.17		
	.28 28°	484	80.67		
	.55 55°	411	68.57		

Remote Driver Selection

Brand	Manufacturer code	Type	Watt	IP Rate	Number of fixtures
Meanwell	LPV-20-24	constant voltage 24V DC	20W	IP67	min 1 - max 3
Meanwell	LPV-35-24	constant voltage 24V DC	35W	IP67	min 1 - max 5
Meanwell	LPV-60-24	constant voltage 24V DC	60W	IP67	min 1 - max 9

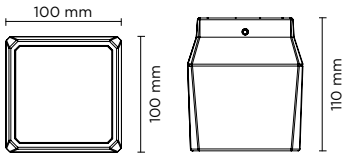

PRODUCT WEIGHT 1,30 kg



Qubo Mini Cob Downlight

Code Example

701102 .27 .14 .01 .0

Accessories p. 326

Surface mounted luminaire for outdoor ceiling installation. Phospho-chromatised and polyester powder coated die-cast copper-free aluminium base and head, tempered safety glass, moulded silicone gaskets, with screws in stainless steel. Built-in LED driver, with 1 COB CREE "CXB 1310" LED. IP66 rating.

701102

10W

CCT	Beam Angle	lm	lm/w	Finish	Dimming
.27 2700°K	.14 14°	1.045	104.50	.01 RAL 9006	.0 ON/OFF
	.35 35°	1.007	100.70	.02 RAL 7016	.D DALI
	.55 55°	950	95.00	.03 Matt Black	
.30 3000°K	.14 14°	1.100	110.00		
	.35 35°	1.060	106.00		
	.55 55°	1.000	100.00		
.40 4000°K	.14 14°	1.200	120.00		
	.35 35°	1.140	114.00		
	.55 55°	1.083	108.00		

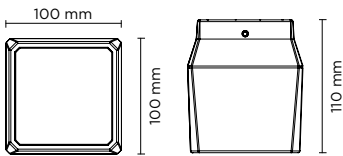

PRODUCT WEIGHT 1,30 kg



Qubo Mini HP Downlight

Code Example

701105 .27 .04 .01 .0

Accessories p. 326

Surface mounted luminaire for outdoor ceiling installation. Phospho-chromatised and polyester powder coated die-cast copper-free aluminium base and head, tempered safety glass, moulded silicone gaskets, with screws in stainless steel. Remote 24V DC power supply needed, with 1 x CREE "XHP35" LED. IP66 rating.

7011005

8W

CCT	Beam Angle	lm	lm/w	Finish	Dimming
.27 2700°K	.04 4°	655	81.87	.01 RAL 9006	.0 ON/OFF
	.10 10°	629	78.62	.02 RAL 7016	.D DALI
	.28 28°	610	76.25	.03 Matt Black	
	.55 55°	383	47.87		
.30 3000°K	.04 4°	690	86.25		
	.10 10°	662	82.75		
	.28 28°	642	80.25		
	.55 55°	403	67.15		
.40 4000°K	.04 4°	703	87.88		
	.10 10°	676	84.50		
	.28 28°	656	82.00		
	.55 55°	558	69.70		

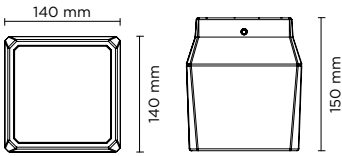

PRODUCT WEIGHT 3,10 kg



Qubo Medium Cob Downlight

Code Example

701103 .27 .14 .01 .0

Accessories p. 326

Surface mounted luminaire for outdoor ceiling installation. Phospho-chromatised and polyester powder coated die-cast copper-free aluminium base and head, tempered safety glass, moulded silicone gaskets, with screws in stainless steel. Built-in LED driver, with 1 COB CREE "CXB 1512" LED. IP66 rating.

701103

16W

CCT	Beam Angle	lm	lm/w	Finish	Dimming
.27 2700°K	.14 14°	1.805	112.81	.01 RAL 9006	.0 ON/OFF
	.35 35°	1.722	107.62	.02 RAL 7016	.1 1-10V
	.55 55°	1.636	102.25	.03 Matt Black	.D DALI
.30 3000°K	.14 14°	1.900	118.75		
	.35 35°	1.813	113.31		
	.55 55°	1.722	107.62		
.40 4000°K	.14 14°	2.000	125.00		
	.35 35°	1.900	118.75		
	.55 55°	1.805	112.81		

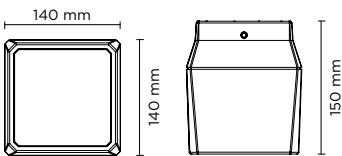

PRODUCT WEIGHT 3,10 kg



Qubo medium HP Downlight

Code Example

701106 .27 .04 .01 .0

Accessories p. 326

Surface mounted luminaire for outdoor ceiling installation. Phospho-chromatised and polyester powder coated die-cast copper-free aluminium base and head, tempered safety glass, moulded silicone gaskets, with screws in stainless steel. Built-in LED driver, with 3 x CREE "XHP35" LED. IP66 rating.

701106

20W

CCT	Beam Angle	lm	lm/w	Finish	Dimming
.27 2700°K	.04 4°	1.947	97.35	.01 RAL 9006	.0 ON/OFF
	.10 10°	1.900	95.00	.02 RAL 7016	.1 1-10V
	.28 28°	1.852	92.60	.03 Matt Black	.D DALI
	.55 55°	1.575	78.75		
.30 3000°K	.04 4°	2.050	102.50		
	.10 10°	2.000	100.00		
	.28 28°	1.950	97.50		
	.55 55°	1.658	82.88		
.40 4000°K	.04 4°	2.100	105.00		
	.10 10°	2.050	102.50		
	.28 28°	2.000	100.00		
	.55 55°	1.700	85.00		

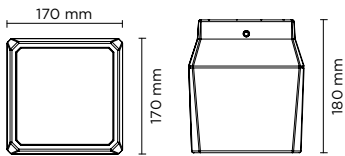

PRODUCT WEIGHT 4,50 kg



Qubo Maxi Cob Downlight

Code Example

701104 .27 .14 .01 .0

Accessories p. 326

Surface mounted luminaire for outdoor ceiling installation. Phospho-chromatised and polyester powder coated die-cast copper-free aluminium base and head, tempered safety glass, moulded silicone gaskets, with screws in stainless steel. Built-in LED driver, with 1 COB CREE "CXB 2540" LED. IP66 rating.

701104
42W

CCT	Beam Angle	lm	lm/w	Finish	Dimming
.27 2700°K	.14 14°	4.702	111.95	.01 RAL 9006	.0 ON/OFF
	.35 35°	4.514	107.48	.02 RAL 7016	.1 1-10V
	.55 55°	4.332	103.14	.03 Matt Black	.D DALI
.30 3000°K	.14 14°	4.950	117.85		
	.35 35°	4.752	113.14		
	.55 55°	4.560	108.57		
.40 4000°K	.14 14°	5.265	125.36		
	.35 35°	5.000	119.05		
	.55 55°	4.770	113.57		

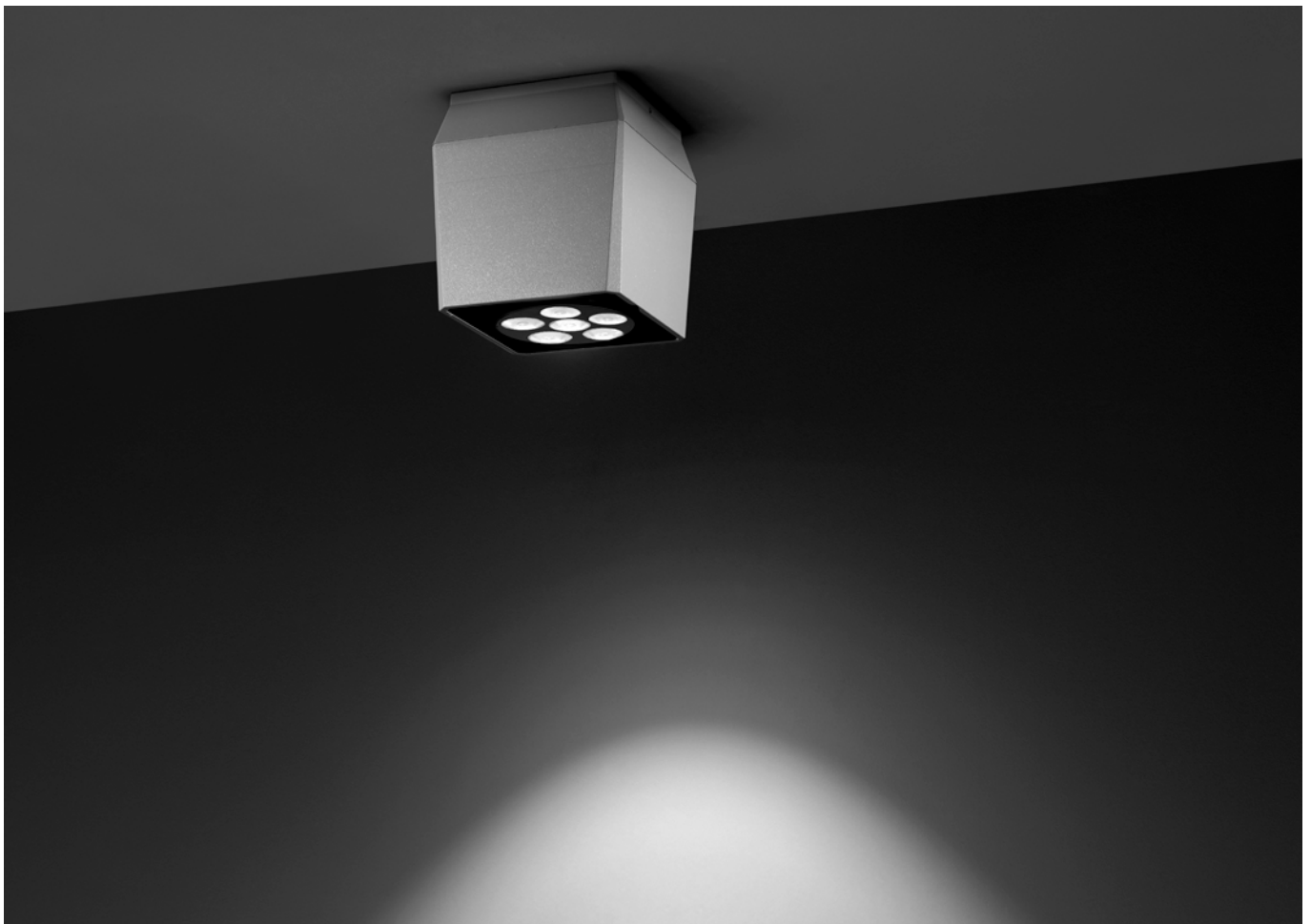

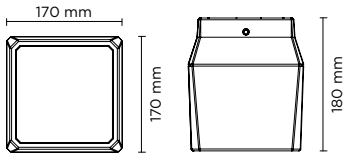

PRODUCT WEIGHT 4,50 kg



Qubo Maxi HP Downlight

Surface mounted luminaire for outdoor ceiling installation. Phospho-chromatised and polyester powder coated die-cast copper-free aluminium base and head, tempered safety glass, moulded silicone gaskets, with screws in stainless steel. Built-in LED driver, with 6 x CREE "XHP35" LED. IP66 rating.

Code Example

701107 .27 .04 .01 .0

Accessories p. 326

701107

38W

CCT	Beam Angle	lm	lm/w	Finish	Dimming
.27 2700°K	.04 4°	4.085	107.50	.01 RAL 9006	.0 ON/OFF
	.10 10°	4.047	106.50	.02 RAL 7016	.1 1-10V
	.28 28°	3.999	105.24	.03 Matt Black	.D DALI
	.55 55°	3.400	89.47		
.30 3000°K	.04 4°	4.300	113.15		
	.10 10°	4.260	112.10		
	.28 28°	4.210	110.79		
	.55 55°	3.579	94.17		
.40 4000°K	.04 4°	4.400	115.79		
	.10 10°	4.360	114.74		
	.28 28°	4.310	113.42		
	.55 55°	3.664	96.41		

INTEGRATED ACCESSORIES

701101 .27 .04 .01 .0

Built-in accessories to be requested when ordering
example 701101.27.04.01.0.HC



.HC

HONEYCOMB LOUVER

A honeycomb structure designed to control the light beam, reduce glare, and prevent direct exposure to the light source.

Compatible for all products of the series.

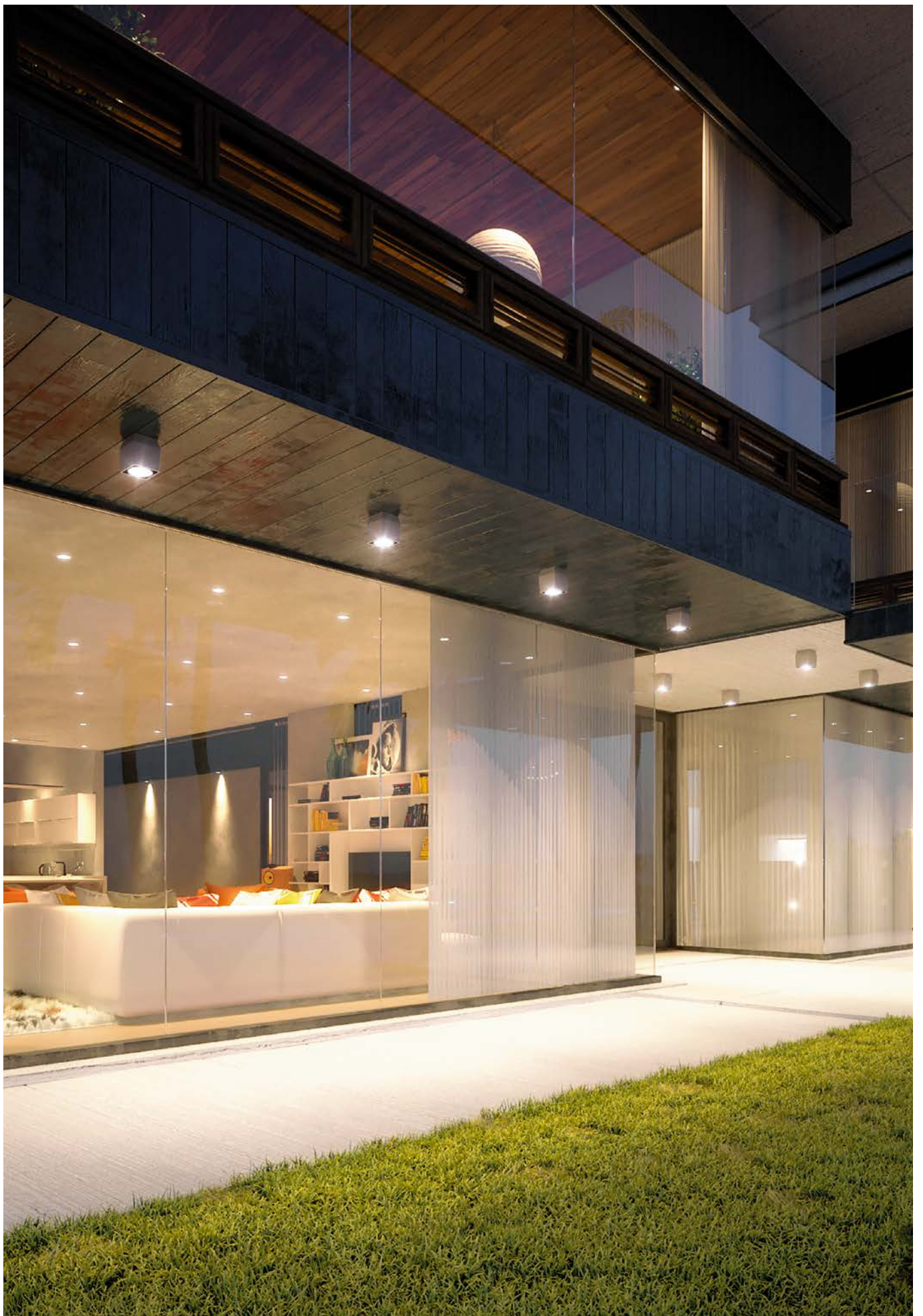

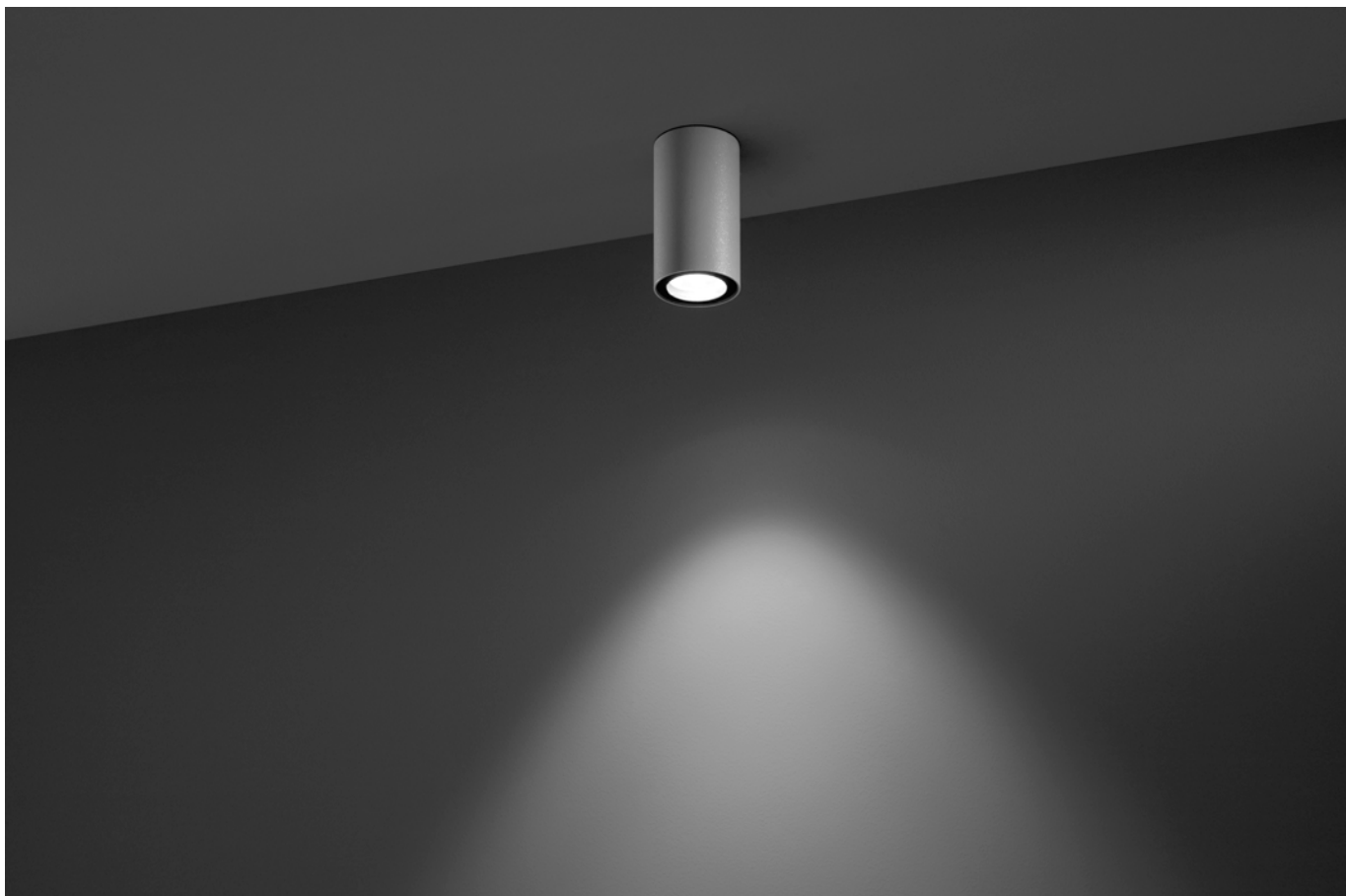

Cylinder

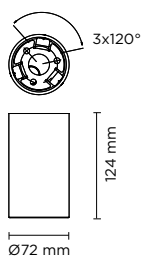

PRODUCT WEIGHT 1,00 kg

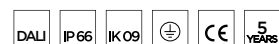

Code Example

701201, .27, .18, .01, 0

Accessories p. 332

701201

6W

Cylinder Micro Cob

Surface mounted luminaire for outdoor ceiling installation. Phospho-chromatised and polyester powder coated extruded copper-free aluminium body, tempered safety glass, moulded silicone gaskets, with screws in stainless steel. Built-in LED driver, with 1 COB CREE "CXB 1304" LED. IP66 rating.

CCT	Beam Angle	lm	lm/w	Finish	Dimming
.27 2700°K	.18 18°	589	98.17	.01 RAL 9006	.0 ON/OFF
	.36 36°	570	95.00	.02 RAL 7016	.D DALI
	.60 60°	551	91.83	.03 Matt Black	
.30 3000°K	.18 18°	620	103.33		
	.36 36°	600	100.00		
	.60 60°	580	96.67		
.40 4000°K	.18 18°	640	106.67		
	.36 36°	620	103.33		
	.60 60°	600	100.00		

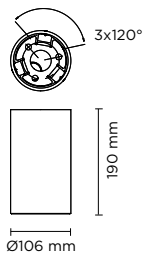

PRODUCT WEIGHT 2,70 kg

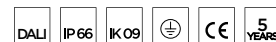

Code Example

701202 · 27 · 14 · 01 · 0

Accessories p. 332

Cylinder Mini Cob

Surface mounted luminaire for outdoor ceiling installation. Phospho-chromatised and polyester powder coated extruded copper-free aluminium body, tempered safety glass, moulded silicone gaskets, with screws in stainless steel. Built-in LED driver, with 1 COB CREE "CXB 1310" LED. IP66 rating.

701202

10W

CCT	Beam Angle	lm	lm/w	Finish	Dimming
.27 2700°K	.14 14°	1.045	104.50	.01 RAL 9006	.0 ON/OFF
	.35 35°	1.007	100.70	.02 RAL 7016	.D DALI
	.55 55°	950	95.00	.03 Matt Black	
.30 3000°K	.14 14°	1.100	110.00		
	.35 35°	1.060	106.00		
	.55 55°	1.000	100.00		
.40 4000°K	.14 14°	1.200	120.00		
	.35 35°	1.140	114.00		
	.55 55°	1.083	108.00		

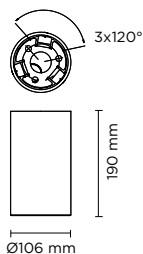

PRODUCT WEIGHT 2,70 kg



Code Example

701205 · 27 · 04 · 01 · 0

Accessories p. 332

Cylinder Mini Hp

Surface mounted luminaire for outdoor ceiling installation. Phospho-chromatised and polyester powder coated extruded copper-free aluminium body, tempered safety glass, moulded silicone gaskets, with screws in stainless steel. Built-in LED driver, with 1 x CREE "XHP35" LED. IP66 rating.

701205

8W

CCT	Beam Angle	lm	lm/w	Finish	Dimming
.27 2700°K	.04 4°	655	81.87	.01 RAL 9006	.0 ON/OFF
	.10 10°	629	78.62	.02 RAL 7016	.D DALI
	.28 28°	610	76.25	.03 Matt Black	
	.55 55°	519	64.87		
.30 3000°K	.04 4°	690	86.25		
	.10 10°	662	82.75		
	.28 28°	642	80.25		
	.55 55°	546	68.21		
.40 4000°K	.04 4°	703	87.88		
	.10 10°	676	84.50		
	.28 28°	656	82.00		
	.55 55°	558	69.70		

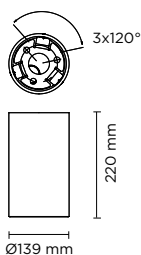

PRODUCT WEIGHT 4,00 kg



Code Example

701203 .27 .14 .01 .0

Accessories p. 332

Cylinder Medium Cob

Surface mounted luminaire for outdoor ceiling installation. Phospho-chromatised and polyester powder coated extruded copper-free aluminium body, tempered safety glass, moulded silicone gaskets, with screws in stainless steel. Built-in LED driver, with 1 COB CREE "CXB 1512" LED. IP66 rating.

701203

16W

CCT	Beam Angle	lm	lm/w	Finish	Dimming
.27 2700°K	.14 14°	1.805	112.81	.01 RAL 9006	.0 ON/OFF
	.35 35°	1.722	107.62	.02 RAL 7016	.1 1-10V
	.55 55°	1.636	102.25	.03 Matt Black	.D DALI
.30 3000°K	.14 14°	1.900	118.75		
	.35 35°	1.813	113.31		
	.55 55°	1.722	107.62		
.40 4000°K	.14 14°	2.000	125.00		
	.35 35°	1.900	118.75		
	.55 55°	1.805	112.81		

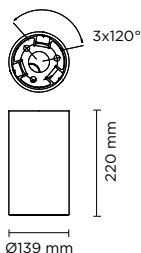

PRODUCT WEIGHT 4,00 kg



Code Example

701206 .27 .04 .01 .0

Accessories p. 332

Cylinder Medium HP

Surface mounted luminaire for outdoor ceiling installation. Phospho-chromatised and polyester powder coated extruded copper-free aluminium body, tempered safety glass, moulded silicone gaskets, with screws in stainless steel. Built-in LED driver, with 3 x CREE "XHP35" LED. IP66 rating.

701206

20W

CCT	Beam Angle	lm	lm/w	Finish	Dimming
.27 2700°K	.04 4°	1.947	97.35	.01 RAL 9006	.0 ON/OFF
	.10 10°	1.900	95.00	.02 RAL 7016	.1 1-10V
	.28 28°	1.852	92.60	.03 Matt Black	.D DALI
	.55 55°	1.575	78.75		
.30 3000°K	.04 4°	2.050	102.50		
	.10 10°	2.000	100.00		
	.28 28°	1.950	97.50		
	.55 55°	1.658	82.88		
.40 4000°K	.04 4°	2.100	105.00		
	.10 10°	2.050	102.50		
	.28 28°	2.000	100.00		
	.55 55°	1.700	85.00		

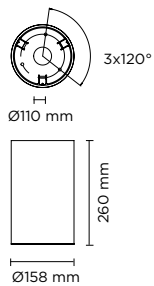

PRODUCT WEIGHT 5,00 kg



Code Example

701204 .27 .14 .01 .0

Accessories p. 332

Cylinder Maxi Cob

Surface mounted luminaire for outdoor ceiling installation. Phospho-chromatised and polyester powder coated extruded copper-free aluminium body, tempered safety glass, moulded silicone gaskets, with screws in stainless steel. Built-in LED driver, with 1 COB CREE "CXB 2540" LED. IP66 rating.

701204

42W

CCT	Beam Angle	lm	lm/w	Finish	Dimming
.27 2700°K	.14 14°	4.702	11.95	.01 RAL 9006	.0 ON/OFF
	.35 35°	4.514	107.48	.02 RAL 7016	.1 1-10V
	.55 55°	4.332	103.14	.03 Matt Black	.D DALI
.30 3000°K	.14 14°	4.950	117.85		
	.35 35°	4.752	113.14		
	.55 55°	4.560	108.57		
.40 4000°K	.14 14°	5.265	125.36		
	.35 35°	5.000	119.05		
	.55 55°	4.770	113.57		



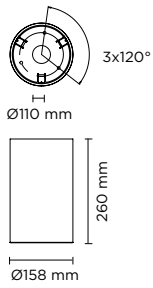

PRODUCT WEIGHT 5.00 kg



Cylinder Maxi HP

Surface mounted luminaire for outdoor ceiling installation. Phospho-chromatised and polyester powder coated extruded copper-free aluminium body, tempered safety glass, moulded silicone gaskets, with screws in stainless steel. Built-in LED driver, with 6 x CREE "XHP35" LED. IP66 rating.

Code Example

701207 .27 .04 .01 .0

Accessories p. 332

701207
38W

CCT	Beam Angle	lm	lm/w	Finish	Dimming
.27 2700°K	.04 4°	4.085	107.50	.01 RAL 9006	.0 ON/OFF
	.10 10°	4.047	106.50	.02 RAL 7016	.1 1-10V
	.28 28°	3.999	105.24		
	.55 55°	3.400	89.47		
.30 3000°K	.04 4°	4.300	113.15	.03 Matt Black	.D DALI
	.10 10°	4.260	112.10		
	.28 28°	4.210	110.79		
	.55 55°	3.579	94.17		
.40 4000°K	.04 4°	4.400	115.79		
	.10 10°	4.360	114.74		
	.28 28°	4.310	113.42		
	.55 55°	3.664	96.41		

INTEGRATED ACCESSORIES

701201 .27 .18 .01 .0

Built-in accessories to be requested when ordering
example 701201.27.18.01.0.HC



.HC

HONEYCOMB LOUVER

A honeycomb structure designed to control the light beam, reduce glare, and prevent direct exposure to the light source.

Compatible for all products of the series.



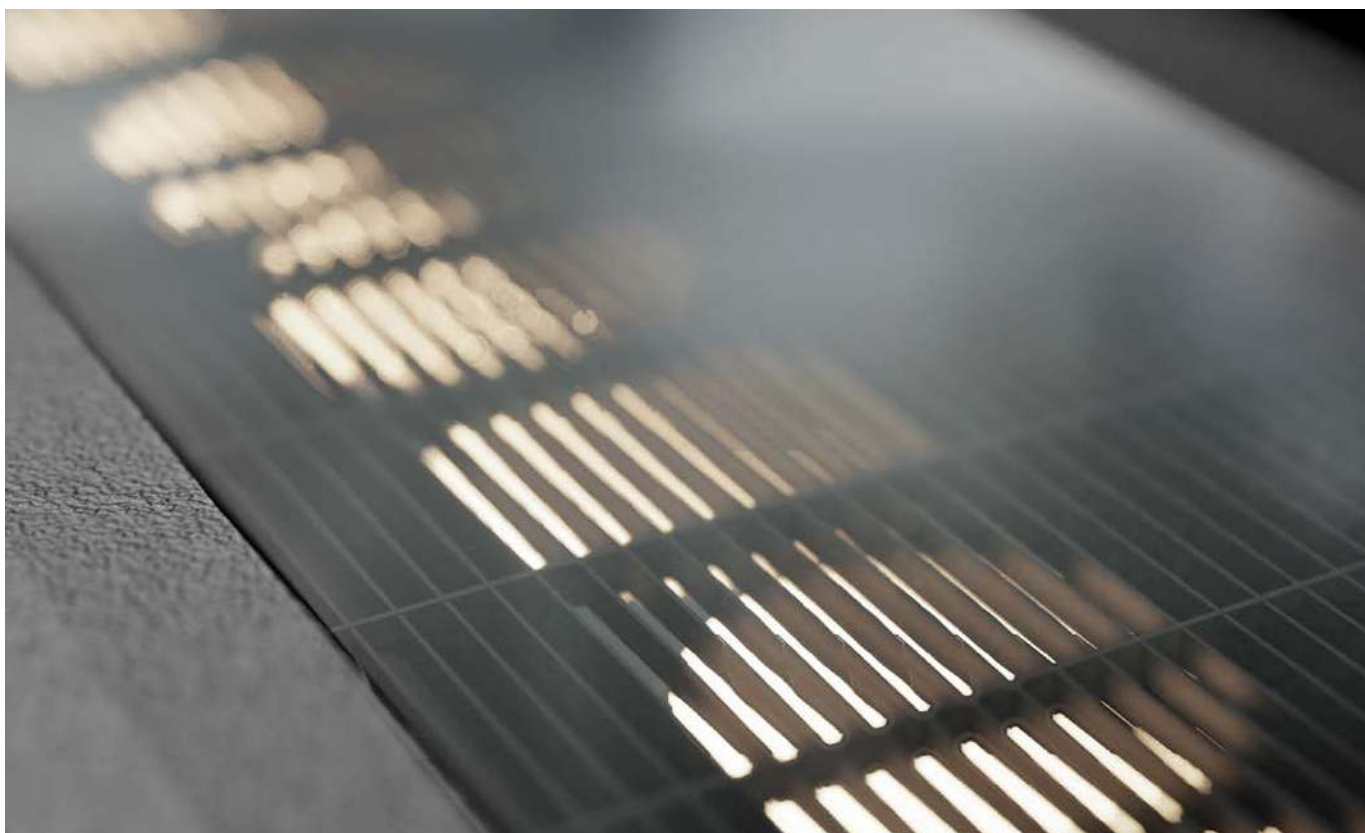

Lineaceiling

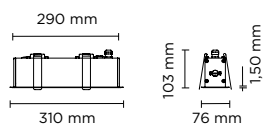

HOLE FOR RECESS

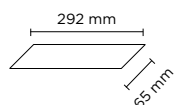

PRODUCT WEIGHT 1,70 kg

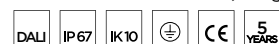

Lineaceiling 300 HP

Code Example

701501.27.15.03.0

Accessories p. 345

Linear shape ceiling-recessed luminaire for outdoor installation, length 310mm, made in phospho-chromatised and polyester powder coated extruded copper-free aluminium, with tempered safety glass, moulded silicone gaskets, stainless steel springs. Light source tilt system +/- 15deg from outside. Built-in LED driver 220-240V 50-60Hz, with 12 x SAMSUNG 3030 LED. IP67 rating.

701501
12W

CCT	Beam Angle	Im	Im/w
.27 2700°K	.15 15°	900	75.00
	.35 35°	870	72.50
	.55 55°	840	70.00
	.WW Asym.Wall Washer	870	72.50
.30 3000°K	.15 15°	930	77.50
	.35 35°	900	75.00
	.55 55°	870	72.50
	.WW Asym.Wall Washer	900	75.00
.40 4000°K	.15 15°	960	80.00
	.35 35°	930	77.50
	.55 55°	900	75.00
	.WW Asym.Wall Washer	930	77.50

Finish	Dimming
.03 Matt Black	.0 ON/OFF
	.D DALI

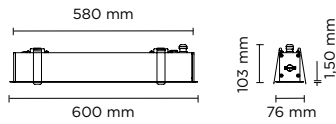

HOLE FOR RECESS

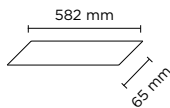

PRODUCT WEIGHT 3,00 kg



Lineaceiling 600 HP

Code Example

701505 .27 .15 .03 .0

Accessories p. 345

Linear shape ceiling-recessed luminaire for outdoor installation, length 600mm, made in phospho-chromatised and polyester powder coated extruded copper-free aluminium, with tempered safety glass, moulded silicone gaskets, stainless steel springs. Light source tilt system +/- 15deg from outside. Built-in LED driver 220-240V 50-60Hz, with 24 x SAMSUNG 3030 LED. IP67 rating.

701505

24W

CCT	Beam Angle	lm	lm/w	Finish	Dimming
.27 2700°K	.15 15°	1.800	75.00	.03 Matt Black	.0 ON/OFF
	.35 35°	1.740	72.50		.D DALI
	.55 55°	1.680	70.00		
	.WW Asym.Wall Washer	1.740	72.50		
.30 3000°K	.15 15°	1.860	77.50		
	.35 35°	1.800	75.00		
	.55 55°	1.740	72.50		
	.WW Asym.Wall Washer	1.800	75.00		
.40 4000°K	.15 15°	1.920	80.00		
	.35 35°	1.860	77.50		
	.55 55°	1.800	75.00		
	.WW Asym.Wall Washer	1.860	77.50		

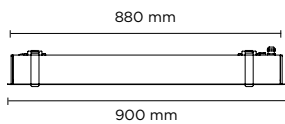

HOLE FOR RECESS

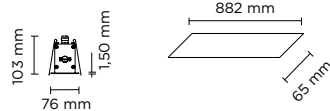

PRODUCT WEIGHT 4,50 kg

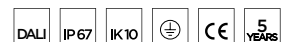

Lineaceiling 900 HP

Code Example

701509 .27 .15 .03 .0

Accessories p. 345

Linear shape ceiling-recessed luminaire for outdoor installation, length 900mm, made in phospho-chromatised and polyester powder coated extruded copper-free aluminium, with tempered safety glass, moulded silicone gaskets, stainless steel springs. Light source tilt system +/- 15deg from outside. Built-in LED driver 220-240V 50-60Hz, with 36 x SAMSUNG 3030 LED. IP67 rating.

701509

36W

CCT	Beam Angle	lm	lm/w	Finish	Dimming
.27 2700°K	.15 15°	2.700	75.00	.03 Matt Black	.0 ON/OFF
	.35 35°	2.610	72.50		.D DALI
	.55 55°	2.520	70.00		
	.WW Asym.Wall Washer	2.610	72.50		
.30 3000°K	.15 15°	2.790	77.50		
	.35 35°	2.700	75.00		
	.55 55°	2.610	72.50		
	.WW Asym.Wall Washer	2.700	75.00		
.40 4000°K	.15 15°	2.880	80.00		
	.35 35°	2.790	77.50		
	.55 55°	2.700	75.00		
	.WW Asym.Wall Washer	2.790	77.50		

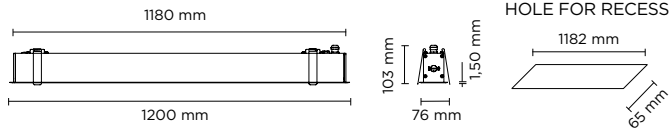

PRODUCT WEIGHT 6,00 kg

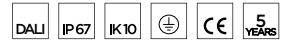

Lineaceiling 1200 HP

Code Example

701513.**27**.**15**.**31**.**0**

Accessories p. 345

Linear shape ceiling-recessed luminaire for outdoor installation, length 1200mm, made in phosphochromatised and polyester powder coated extruded copper-free aluminium, with tempered safety glass, moulded silicone gaskets, stainless steel springs. Light source tilt system +/- 15deg from outside. Built-in LED driver 220-240V 50-60Hz, with 48 x SAMSUNG 3030 LED. IP67 rating.

701513 48W	CCT	Beam Angle	lm	lm/w	Finish	Dimming
	.27 2700°K	.15 15°	.35 35°	3.480	72.50	.03  Matt Black
.55 55°			3.360	70.00	.D DALI	
.WW Asym.Wall Washer			3.480	72.50		
.30 3000°K			.15 15°	.35 35°	3.720	
.55 55°	3.600	75.00				
.WW Asym.Wall Washer	3.480	72.50				
.40 4000°K	.15 15°	.35 35°		3.720	77.50	
		.55 55°	3.600	75.00		
		.WW Asym.Wall Washer	3.720	77.50		





Lineaceiling HP DMX RGBW

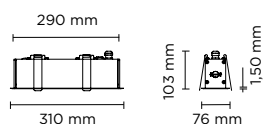

HOLE FOR RECESS

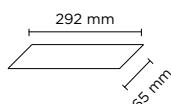

PRODUCT WEIGHT 1,70 kg



Lineaceiling 300 HP DMX RGBW

Code Example

701502.RW.15.03.X

Accessories p. 345

Linear shape ceiling-recessed luminaire for outdoor installation, length 310mm, made in phospho-chromatised and polyester powder coated extruded copper-free aluminium, with tempered safety glass, moulded silicone gaskets, stainless steel springs. Light source tilt system +/- 15deg from outside. Remote 24V DC power supply needed, DMX interface integrated, with 12 x RGBW(3000K) 3535 LED. IP67 rating.

701502
10W

CCT	Beam Angle	lm	lm/w	Finish	Dimming
.RW RGBW	.15 15°	380	38.00	.03 Matt Black	.X DMX
	.30 30°	365	36.50		.D DALI
	.60 60°	335	33.50		
	.E6 10X60° elliptical	365	36.50		

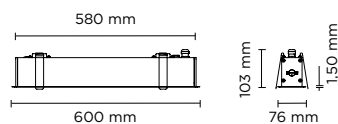

HOLE FOR RECESS

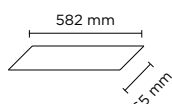

PRODUCT WEIGHT 3,00 kg

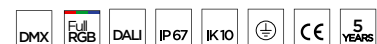

Lineaceiling 600 HP DMX RGBW

Code Example

701506.RW.15.03.X

Accessories p. 345

Linear shape ceiling-recessed luminaire for outdoor installation, length 600mm, made in phospho-chromatised and polyester powder coated extruded copper-free aluminium, with tempered safety glass, moulded silicone gaskets, stainless steel springs. Light source tilt system +/- 15deg from outside. Built-in LED driver 220-240V 50-60Hz, DMX interface integrated, with 24 x RGBW(3000K) 3535 LED. IP67 rating.

701506
20W

CCT	Beam Angle	lm	lm/w	Finish	Dimming
.RW RGBW	.15 15°	760	38.00	.03 Matt Black	.X DMX
	.30 30°	730	36.50		.D DALI
	.60 60°	670	33.50		
	.E6 10X60° elliptical	730	36.50		

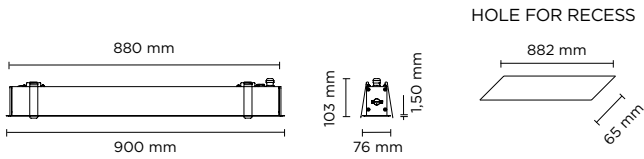

PRODUCT WEIGHT 4,50 kg



Lineaceiling 900 HP DMX RGBW

Code Example

701510, .RW, .15, .03, X

Accessories p. 345

Linear shape ceiling-recessed luminaire for outdoor installation, length 900mm, made in phospho-chromatised and polyester powder coated extruded copper-free aluminium, with tempered safety glass, moulded silicone gaskets, stainless steel springs. Light source tilt system +/- 15deg from outside. Built-in LED driver 220-240V 50-60Hz, DMX interface integrated, with 36 x RGBW(3000K) 3535 LED. IP67 rating.

CCT	Beam Angle	lm	lm/w	Finish	Dimming
701510 30W	.15 15°	1.140	38.00	.03 Matt Black	.X DMX
	.30 30°	1.095	36.50		.D DALI
	.60 60°	1.005	33.50		
	.E6 10X60° elliptical	1.095	36.50		

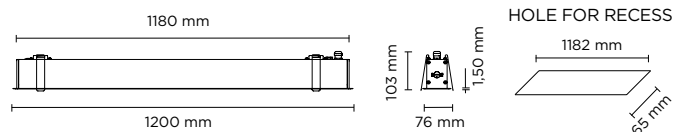

PRODUCT WEIGHT 6,00 kg



Lineaceiling 1200 HP DMX RGBW

Code Example

701514, .RW, .15, .03, X

Accessories p. 345

Linear shape ceiling-recessed luminaire for outdoor installation, length 1200mm, made in phospho-chromatised and polyester powder coated extruded copper-free aluminium, with tempered safety glass, moulded silicone gaskets, stainless steel springs. Light source tilt system +/- 15deg from outside. Built-in LED driver 220-240V 50-60Hz, DMX interface integrated, with 48 x RGBW(3000K) 3535 LED. IP67 rating.

CCT	Beam Angle	lm	lm/w	Finish	Dimming
701514 40W	.15 15°	1.520	38.00	.03 Matt Black	.X DMX
	.30 30°	1.460	36.50		.D DALI
	.60 60°	1.340	33.50		
	.E6 10X60° elliptical	1.460	36.50		



Lineaceiling HP DMX Tunable white

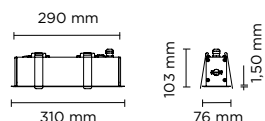

HOLE FOR RECESS

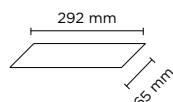

PRODUCT WEIGHT 1,70 kg



Lineaceiling 300 HP Dmx Tunable White

Code Example

701503.TW.15.03.X

Accessories p. 345

Linear shape ceiling-recessed luminaire for outdoor installation, length 310mm, made in phospho-chromatised and polyester powder coated extruded copper-free aluminium, with tempered safety glass, moulded silicone gaskets, stainless steel springs. Light source tilt system +/- 15deg from outside. Remote 24V DC power supply needed, DMX interface integrated, with 12 x Tunable White 3535 LED (2700K-5600K). IP67 rating.

701503
10W

CCT	Beam Angle	lm	lm/w
.TW 2700°K 5600°K	.15 15°	650	65.00
	.30 30°	635	63.50
	.60 60°	620	62.00
	.E6 10X60° elliptical	635	63.50

Finish

.03 Matt Black

Dimming

.X DMX

.D DALI

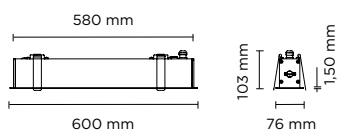

HOLE FOR RECESS

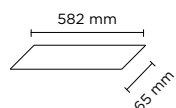

PRODUCT WEIGHT 3,00 kg



Lineaceiling 600 HP Dmx Tunable White

Code Example

701507.TW.15.03.X

Accessories p. 345

Linear shape ceiling-recessed luminaire for outdoor installation, length 600mm, made in phospho-chromatised and polyester powder coated extruded copper-free aluminium, with tempered safety glass, moulded silicone gaskets, stainless steel springs. Light source tilt system +/- 15deg from outside. Built-in LED driver 220-240V 50-60Hz, DMX interface integrated, with 24 x Tunable White 3535 LED (2700K-5600K). IP67 rating.

701507
20W

CCT	Beam Angle	lm	lm/w
.TW 2700°K 5600°K	.15 15°	1.300	65.00
	.30 30°	1.270	63.50
	.60 60°	1.240	62.00
	.E6 10X60° elliptical	1.270	63.50

Finish

.03 Matt Black

Dimming

.X DMX

.D DALI

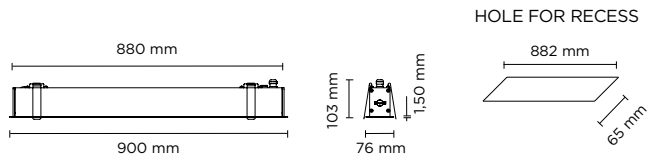

PRODUCT WEIGHT 4,50 kg



Lineaceiling 900 HP Dmx Tunable White

Code Example

701511 · TW · 15 · 03 · X

Accessories p. 345

Linear shape ceiling-recessed luminaire for outdoor installation, length 900mm, made in phospho-chromatised and polyester powder coated extruded copper-free aluminium, with tempered safety glass, moulded silicone gaskets, stainless steel springs. Light source tilt system +/- 15deg from outside. Built-in LED driver 220-240V 50-60Hz, DMX interface integrated, with 36 x Tunable White 3535 LED (2700K-5600K). IP67 rating.

701511
30W

CCT	Beam Angle	lm	lm/w
.TW 2700°K 5600°K	.15 15°	1.950	65.00
	.30 30°	1.905	63.50
	.60 60°	1.860	62.00
	.E6 10X60° elliptical	1.905	63.50

Finish	Dimming
.03 Matt Black	.X DMX .D DALI

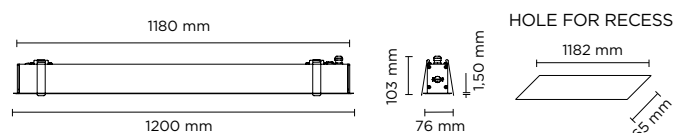

PRODUCT WEIGHT 6,00 kg



Lineaceiling 1200 HP Dmx Tunable White

Code Example

701515 · TW · 15 · 03 · X

Accessories p. 345

Linear shape ceiling-recessed luminaire for outdoor installation, length 1200mm, made in phospho-chromatised and polyester powder coated extruded copper-free aluminium, with tempered safety glass, moulded silicone gaskets, stainless steel springs. Light source tilt system +/- 15deg from outside. Built-in LED driver 220-240V 50-60Hz, DMX interface integrated, with 48 x Tunable White 3535 LED (2700K-5600K). IP67 rating.

701515
40W

CCT	Beam Angle	lm	lm/w
.TW 2700°K 5600°K	.15 15°	2.600	65.00
	.30 30°	2.540	63.50
	.60 60°	2.480	62.00
	.E6 10X60° elliptical	2.540	63.50

Finish	Dimming
.03 Matt Black	.X DMX .D DALI



Lineaceiling Diffused

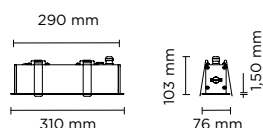

HOLE FOR RECESS



PRODUCT WEIGHT 1,70 kg

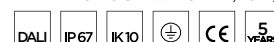

Code Example

701504.27.DF.03.0

Accessories p. 345

Lineaceiling 300 Diffused

Linear shape ceiling-recessed luminaire for outdoor installation, length 310mm, made in phospho-chromatised and polyester powder coated extruded copper-free aluminium, with tempered safety glass, moulded silicone gaskets, stainless steel springs. Light source tilt system +/- 15deg from outside. Built-in LED driver 220-240V 50-60Hz, with 12 x SAMSUNG 3030 LED. IP67 rating.

701504
8W

CCT	Beam Angle	lm	lm/w
.27 2700°K	.DF Diffused	300	37.50
.30 3000°K	.DF Diffused	310	38.75
.40 4000°K	.DF Diffused	330	41.25

Finish	Dimming
.03 Matt Black	.0 ON/OFF
	.D DALI

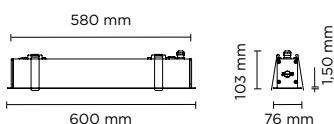

HOLE FOR RECESS



PRODUCT WEIGHT 3,00 kg

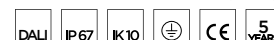

Code Example

701508.27.DF.03.0

Accessories p. 345

Lineaceiling 600 Diffused

Linear shape ceiling-recessed luminaire for outdoor installation, length 600mm, made in phospho-chromatised and polyester powder coated extruded copper-free aluminium, with tempered safety glass, moulded silicone gaskets, stainless steel springs. Light source tilt system +/- 15deg from outside. Built-in LED driver 220-240V 50-60Hz, with 24 x SAMSUNG 3030 LED. IP67 rating.

701508
12W

CCT	Beam Angle	lm	lm/w
.27 2700°K	.DF Diffused	500	41.66
.30 3000°K	.DF Diffused	520	43.33
.40 4000°K	.DF Diffused	550	45.83

Finish	Dimming
.03 Matt Black	.0 ON/OFF
	.D DALI

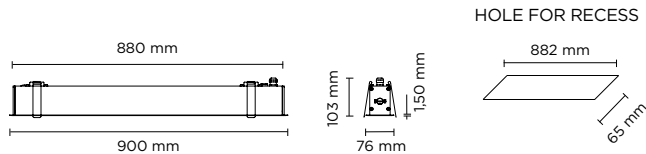

PRODUCT WEIGHT 4,50 kg

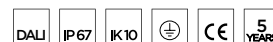

Lineaceiling 900 Diffused

Code Example

701512.27.DF.03.0

Accessories p. 345

Linear shape ceiling-recessed luminaire for outdoor installation, length 900mm, made in phospho-chromatised and polyester powder coated extruded copper-free aluminium, with tempered safety glass, moulded silicone gaskets, stainless steel springs. Light source tilt system +/- 15deg from outside. Built-in LED driver 220-240V 50-60Hz, with 36 x SAMSUNG 3030 LED. IP67 rating.

	CCT	Beam Angle	lm	lm/w	Finish	Dimming
701512	.27 2700°K	.DF Diffused	780	45.88	.03 Matt Black	.0 ON/OFF
17W	.30 3000°K	.DF Diffused	800	47.06		.D DALI
	.40 4000°K	.DF Diffused	830	48.80		

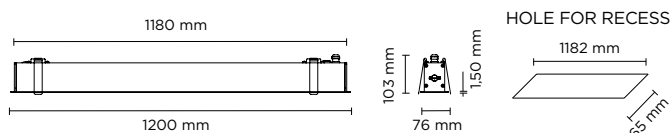

PRODUCT WEIGHT 6,00 kg

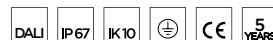

Lineaceiling 1200 Diffused

Code Example

701516.27.DF.03.0

Accessories p. 345

Linear shape ceiling-recessed luminaire for outdoor installation, length 1200mm, made in phospho-chromatised and polyester powder coated extruded copper-free aluminium, with tempered safety glass, moulded silicone gaskets, stainless steel springs. Light source tilt system +/- 15deg from outside. Built-in LED driver 220-240V 50-60Hz, with 48 x SAMSUNG 3030 LED. IP67 rating.

	CCT	Beam Angle	lm	lm/w	Finish	Dimming
701516	.27 2700°K	.DF Diffused	1.010	42.08	.03 Matt Black	.0 ON/OFF
24W	.30 3000°K	.DF Diffused	1.050	43.75		.D DALI
	.40 4000°K	.DF Diffused	1.100	45.83		

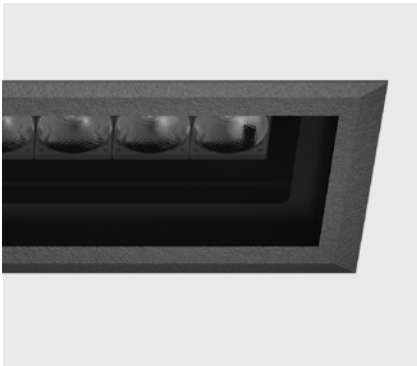

NO EXPOSED
SCREWS ONCE
THE PRODUCT IS
INSTALLED

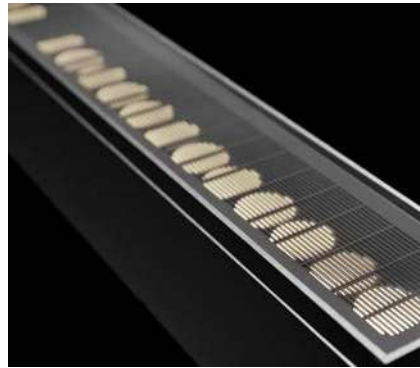

PLENTY OF
SOLUTIONS AS
ANTI-GLARE
ACCESSORIES



only
12 mm

REDUCED WIDTH
AT 12 MM
FOR BETTER
AESTHETIC
IMPACT



VARIETY OF
LIGHT SOURCE
& MODELS



SPECIAL
TILT SYSTEM
INTEGRATED
ALLOWING
ON SITE
ADJUSTMENT
+/- 15 DEG
WITHOUT
OPENING
THE LUMINAIRE

LIGHT BEAM OPTIONS

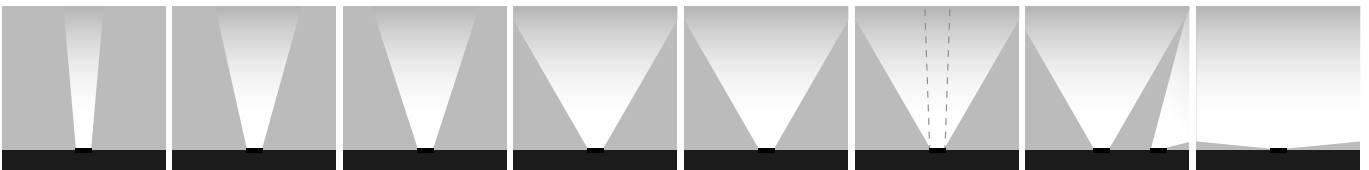

NARROW 15°

MEDIUM 30°

MEDIUM
WIDE 35°

WIDE
FLOOD 55°

WIDE
FLOOD 60°

10x60°
ELLIPTICAL

ASYMMETRIC
WALL-WASHER

DIFFUSED

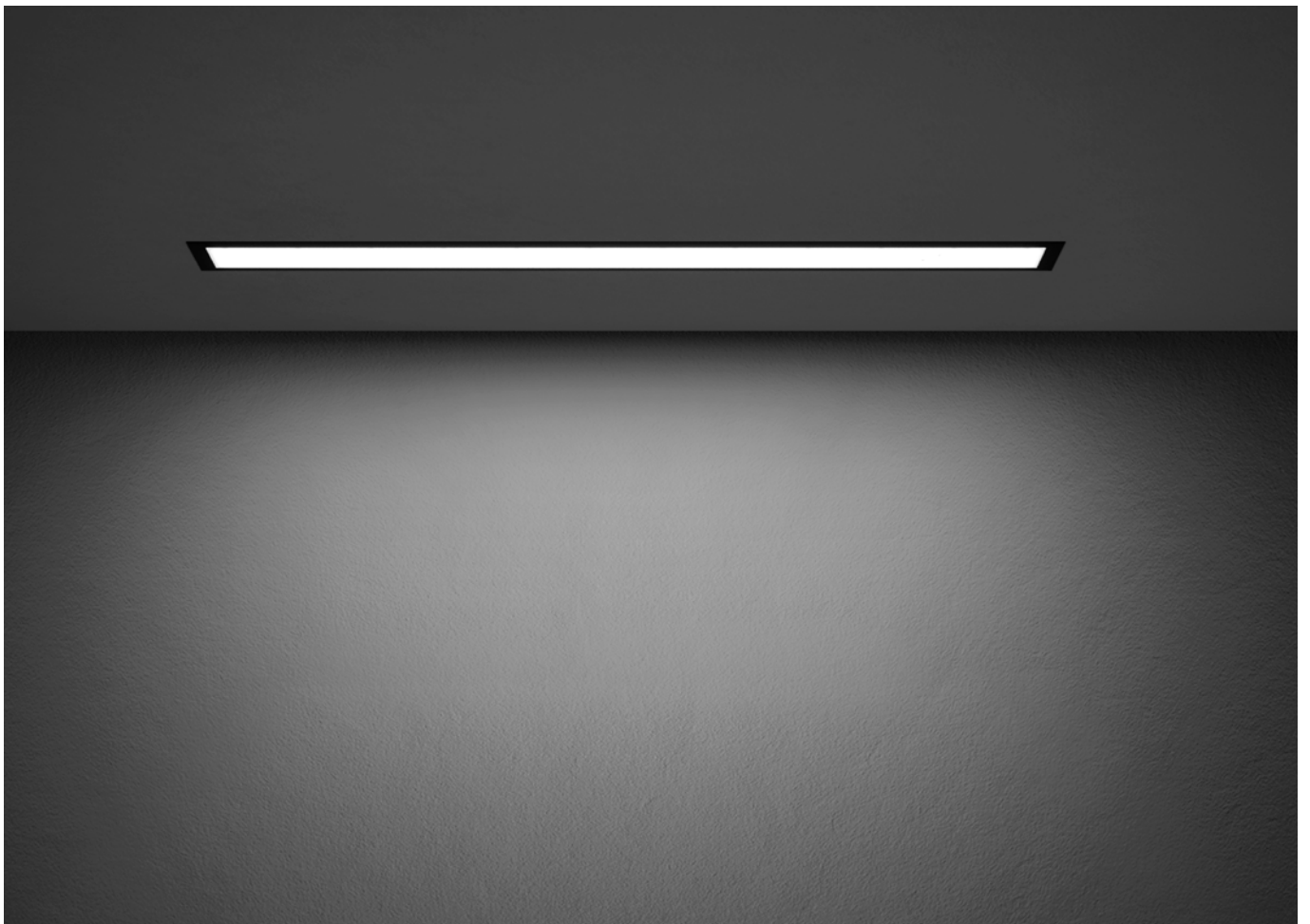

INTEGRATED ACCESSORIES

701501.27.15.01.0. --

Built-in accessories to be requested when ordering
example 701501.27.15.01.0.**ML**



.ML

MICROLOUVRE

Anti-glare grid that sections the light beam into microcells, adding visual comfort without compromising the quality or homogeneity of the light.

Available for:

- LINEACEILING HP ITEMS
- LINEACEILING HP DMX RGBW ITEMS
- LINEACEILING HP DMX TUNABLE WHITE ITEMS

ACCESSORIES NOT INCLUDED

Accessories to be ordered separately.



AC133

FEED CABLE 1 MT. ON/OFF

Initial cable 3 core, to start an in-line installation, cable length 1 meter.
Open wires for mains connection and IP68 connector for fixture connection.

Available for:

- LINEACEILING HP ITEMS
- LINEACEILING HP DMX RGBW ITEMS
- LINEACEILING HP DMX TUNABLE WHITE ITEMS
- LINEACEILING DIFFUSED ITEMS



AC137

JUMPER CABLE 4 MT. ON/OFF

4 meters length extension, 3 core cable with male and female IP68 connectors (end to end).

Available for:

- LINEACEILING HP ITEMS
- LINEACEILING HP DMX RGBW ITEMS
- LINEACEILING HP DMX TUNABLE WHITE ITEMS
- LINEACEILING DIFFUSED ITEMS



AC134

FEED CABLE 1 MT. DALI

Initial cable 5 core, to start an in-line DALI installation, cable length 1 meter.
Open wires for mains connection and IP68 connector for fixture connection.

Available for:

- LINEACEILING HP ITEMS
- LINEACEILING DIFFUSED ITEMS



AC138

JUMPER CABLE 4 MT. DALI

4 meters length extension, 5 core DALI cable with male and female IP68 connectors (end to end).

Available for:

- LINEACEILING HP ITEMS
- LINEACEILING DIFFUSED ITEMS



AC135

JUMPER CABLE 2 MT. ON/OFF

2 meters length extension, 3 core cable with male and female IP68 connectors (end to end).

Available for:

- LINEACEILING HP ITEMS
- LINEACEILING HP DMX RGBW ITEMS
- LINEACEILING HP DMX TUNABLE WHITE ITEMS
- LINEACEILING DIFFUSED ITEMS



AC139

END CAP ON/OFF

End cap for connectors, to terminate the in-line installation of light fixture equipped with 3 core cable.

Available for:

- LINEACEILING HP ITEMS
- LINEACEILING HP DMX RGBW ITEMS
- LINEACEILING HP DMX TUNABLE WHITE ITEMS
- LINEACEILING DIFFUSED ITEMS



AC136

JUMPER CABLE 2 MT. DALI

2 meters length extension, 5 core DALI cable with male and female IP68 connectors (end to end).

Available for:

- LINEACEILING HP ITEMS
- LINEACEILING DIFFUSED ITEMS



AC140

END CAP DALI

End cap for connectors, to terminate the in-line installation of light fixture equipped with 5 core cable (DALI).

Available for:

- LINEACEILING HP ITEMS
- LINEACEILING DIFFUSED ITEMS



Lineaceiling “Continuous Line” System

701501L	Lineaceiling 300 HP - left	701506R	Lineaceiling 600 HP DMX RGBW - right
701501R	Lineaceiling 300 HP - right	701506X	Lineaceiling 600 HP DMX RGBW - intermediate
701501X	Lineaceiling 300 HP - intermediate	701507L	Lineaceiling 600 HP DMX tunable white - left
701502L	Lineaceiling 300 HP DMX RGBW - left	701507R	Lineaceiling 600 HP DMX tunable white - right
701502R	Lineaceiling 300 HP DMX RGBW - right	701507X	Lineaceiling 600 HP DMX tunable white intermediate
701502X	Lineaceiling 300 HP DMX RGBW - intermediate	701508L	Lineaceiling 600 diffused - left
701503L	Lineaceiling 300 HP DMX tunable white - left	701508R	Lineaceiling 600 diffused - right
701503R	Lineaceiling 300 HP DMX tunable white - right	701508X	Lineaceiling 600 diffused intermediate
701503X	Lineaceiling 300 HP DMX tunable white intermediate	701509L	Lineaceiling 900 HP - left
701504L	Lineaceiling 300 diffused - left	701509R	Lineaceiling 900 HP - right
701504X	Lineaceiling 300 diffused - right	701509X	Lineaceiling 900 HP - intermediate
701504L	Lineaceiling 300 diffused - intermediate	701510L	Lineaceiling 900 HP DMX RGBW - left
701505L	Lineaceiling 600 HP - left	701510R	Lineaceiling 900 HP DMX RGBW - right
701505R	Lineaceiling 600 HP - right	701510X	Lineaceiling 900 HP DMX RGBW intermediate
701505X	Lineaceiling 600 HP - intermediate	701511L	Lineaceiling 900 HP DMX tunable white - left
701506L	Lineaceiling 600 HP DMX RGBW - left	701511R	Lineaceiling 900 HP DMX tunable white - right
		701511X	Lineaceiling 900 HP DMX tunable white intermediate



ACCESSORIES

ACCESSORIES LINEACEILING LINEACEILING CONTINUOUS LINE

701512L	Lineaceiling 900 diffused - left
701512R	Lineaceiling 900 diffused - right
701512X	Lineaceiling 900 diffused - intermediate
701513L	Lineaceiling 1200 HP - left
701513R	Lineaceiling 1200 HP - right
701513X	Lineaceiling 1200 HP - intermediate
701514L	Lineaceiling 1200 HP DMX RGBW - left
701514R	Lineaceiling 1200 HP DMX RGBW - right
701514X	Lineaceiling 1200 HP DMX RGBW - intermediate
701515L	Lineaceiling 1200 HP DMX tunable white left
701515R	Lineaceiling 1200 HP DMX tunable white - right
701515X	Lineaceiling 1200 HP DMX tunable white intermediate
701516L	Lineaceiling 1200 diffused - left
701516R	Lineaceiling 1200 diffused - right
701516X	Lineaceiling 1200 diffused - intermediate

.ML	Microouvre 300. Built-in accessories to be requested when ordering example 701501.27.15.03.0. ML
.ML	Microouvre 600. Built-in accessories to be requested when ordering example 701505.27.15.03.0. ML
.ML	Microouvre 900. Built-in accessories to be requested when ordering example 701509.27.15.03.0. ML
.ML	Microouvre 1200. Built-in accessories to be requested when ordering example 701513.27.15.03.0. ML
AC133	Feed Cable 1 Mt. On/Off
AC134	Feed Cable 1 Mt. DALI
AC135	Jumper Cable 2 Mt. On/Off
AC136	Jumper Cable 2 Mt. DALI
AC137	Jumper Cable 4 Mt. On/Off
AC138	Jumper Cable 4 Mt. DALI
AC139	End Cap On/Off
AC140	End Cap DALI

UR BAN LIGH TS





Plaza

Nava + Arosio

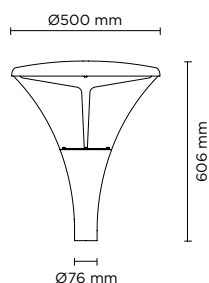

PRODUCT WEIGHT 9,00 kg



Code Example

809001 .27 .AL .01 .0

Accessories p. 353

Plaza 25

Round pole-top mounted luminaire for outdoor installation on a pole diam. 60 mm (or 76 mm using pole adapter). Phospho-chromatised and polyester powder coated die-cast copper-free aluminium body, polycarbonate diffuser, moulded silicone gasket and stainless steel screws Built-in LED driver 220-240V 50-60Hz, with 50 x Lumileds / Luxeon DS207 LED. IP66 rating.

809001
25W

CCT	Beam Angle	lm	lm/w	Finish	Dimming
.27 2700°K	.AL 360°	1.960	78.40	.01 RAL 9006	.0 ON/OFF
.30 3000°K	.AL 360°	2.063	82.52	.02 RAL 7016	.1 1-10 V
.40 4000°K	.AL 360°	2.160	86.40	.03 Matt Black	.D DALI

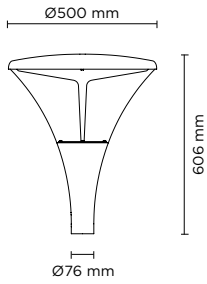

PRODUCT WEIGHT 9,00 kg



Code Example

809002.27.AL.01.0

Accessories p. 353

Plaza 45

Round pole-top mounted luminaire for outdoor installation on a pole diam. 60 mm (or 76 mm using pole adapter). Phospho-chromatised and polyester powder coated die-cast copper-free aluminium body, polycarbonate diffuser, moulded silicone gasket and stainless steel screws Built-in LED driver 220-240V 50-60Hz, with 70 x Lumileds / Luxeon DS207 LED. IP66 rating.

809002

45W

CCT	Beam Angle	lm	lm/w	Finish	Dimming
.27 2700°K	.AL 360°	3.526	78.36	.01 RAL 9006	.0 ON/OFF
.30 3000°K	.AL 360°	3.712	82.48	.02 RAL 7016	.1 1-10 V
.40 4000°K	.AL 360°	3.810	84.67	.03 Matt Black	.D DALI

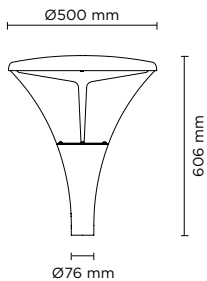

PRODUCT WEIGHT 9,00 kg



Code Example

809003.27.AL.01.0

Accessories p. 353

Plaza 70

Round pole-top mounted luminaire for outdoor installation on a pole diam. 60 mm (or 76 mm using pole adapter). Phospho-chromatised and polyester powder coated die-cast copper-free aluminium body, polycarbonate diffuser, moulded silicone gasket and stainless steel screws Built-in LED driver 220-240V 50-60Hz, with 80 x Lumileds / Luxeon DS207 LED. IP66 rating.

809003

70W

CCT	Beam Angle	lm	lm/w	Finish	Dimming
.27 2700°K	.AL 360°	5.486	78.37	.01 RAL 9006	.0 ON/OFF
.30 3000°K	.AL 360°	5.775	82.50	.02 RAL 7016	.1 1-10 V
.40 4000°K	.AL 360°	5.870	83.86	.03 Matt Black	.D DALI



ACCESSORIES NOT INCLUDED

Accessories to be ordered separately.

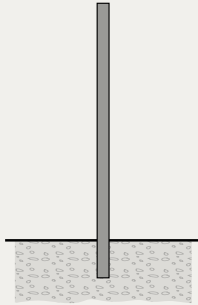
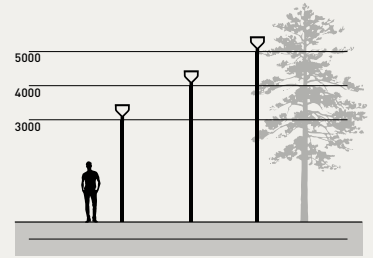

BURIED POLES

code	article	h. mm.	description
809901	cylindrical pole 3,5 meters to be buried	3.500	Cylindrical pole made in steel S235JR (UNI EN 10219) hot galvanized (UNI EN 1461), diameter 76 mm, thickness 4 mm.
809902	cylindrical pole 4,5 meters to be buried	4.500	Phospho-chromatised and polyester powder coated.
809903	cylindrical pole 5,5 meters to be buried	5.500	Total height including 500 mm to be buried into the ground. Includes IP54 cover plate 132x38 mm and terminal block in double insulation.
809908	adapter diam. 76mm -> 60mm		Adapter for pole diam. 76 mm, allow the diameter reduction to 60 mm

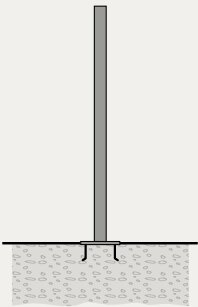

POLES WITH BASE-PLATE

code	article	h. mm.	description
809904	cylindrical pole 3 meters with base-plate	3.000	Cylindrical pole made in steel S235JR (UNI EN 10219) hot galvanized (UNI EN 1461), diameter 76 mm, thickness 4 mm.
809905	cylindrical pole 4 meters with base-plate	4.000	Phospho-chromatised and polyester powder coated.
809906	cylindrical pole 5 meters with base-plate	5.000	With base plate dim. 250x250 mm, thickness 10 mm Includes IP54 cover plate 132x38 mm and terminal block in double insulation.
809907	anchorage unit for base-plate		Base plate dim. 250x250 mm, thickness 3 mm, made in galvanized steel complete of nr. 4 anchorage threaded bolts
809908	adapter diam. 76mm -> 60mm		Adapter for pole diam. 76 mm, allow the diameter reduction to 60 mm





City

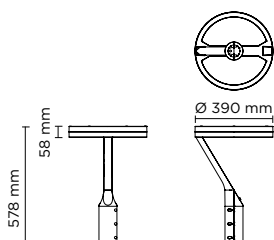

PRODUCT WEIGHT 6,10 kg



Code Example

802001.30.RT.01.0

Accessories p. 357

City 01

Round pole-top mounted luminaire for outdoor installation on a pole diam. 60 mm, single supporting arm, with downward light distribution. Phospho-chromatised and polyester powder coated die-cast copper-free aluminium body, tempered safety glass, moulded silicone gasket and stainless steel screws. Built-in LED driver/s, with number of LEDs from 24 to 48 CREE XP-G3 LED. IP66 rating.

802001
36W



12+12

CCT*	Beam Angle	lm	lm/w	Finish	Dimming
.30 3000°K	.RT roto-symmetrical	3.456	96.00	.01 RAL 9006	.0 ON/OFF
	.CP cycle route pedestrian	3.456	96.00	.02 RAL 7016	.1 1-10 V
	.ST street	3.456	96.00	.03 Matt Black	.D DALI

*Other light colors available on request: Neutral-white

802002
72W



24+24

CCT*	Beam Angle	lm	lm/w	Finish	Dimming
.30 3000°K	.RT roto-symmetrical	6.912	96.00	.01 RAL 9006	.0 ON/OFF
	.CP cycle route pedestrian	6.912	96.00	.02 RAL 7016	.1 1-10 V
	.ST street	6.912	96.00	.03 Matt Black	.D DALI

*Other light colors available on request: Neutral-white

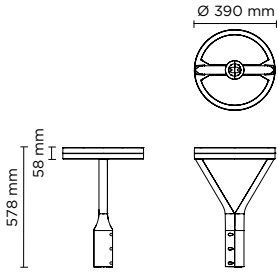

PRODUCT WEIGHT 6,30 kg



City 02

Code Example

802003.30.RT.01.0

Accessories p. 357

Round pole-top mounted luminaire for outdoor installation on a pole diam. 60 mm, double supporting arm, with downward light distribution. Phospho-chromatised and polyester powder coated die-cast copper-free aluminium body, tempered safety glass, moulded silicone gasket and stainless steel screws. Built-in LED driver/s, with number of LEDs from 12 to 48 CREE XP-G3 LED. IP66 rating.

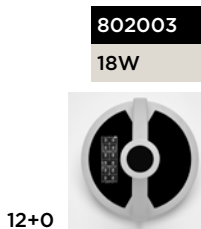

12+0

CCT*	Beam Angle	Im	Im/w	Finish	Dimming
.30 3000°K	.RT roto-symmetrical	1.728	96.00	.01 RAL 9006	.0 ON/OFF
	.CP cycle route pedestrian	1.728	96.00	.02 RAL 7016	.1 1-10 V
	.ST street	1.728	96.00	.03 Matt Black	.D DALI

*Other light colors available on request: Neutral-white

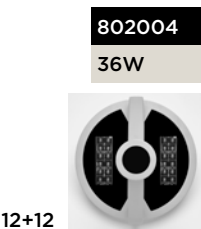

12+12

CCT*	Beam Angle	Im	Im/w	Finish	Dimming
.30 3000°K	.RT roto-symmetrical	3.456	96.00	.01 RAL 9006	.0 ON/OFF
	.CP cycle route pedestrian	3.456	96.00	.02 RAL 7016	.1 1-10 V
	.ST street	3.456	96.00	.03 Matt Black	.D DALI

*Other light colors available on request: Neutral-white

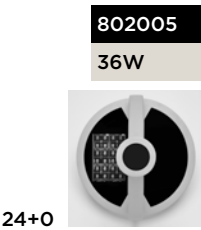

24+0

CCT*	Beam Angle	Im	Im/w	Finish	Dimming
.30 3000°K	.RT roto-symmetrical	3.456	96.00	.01 RAL 9006	.0 ON/OFF
	.CP cycle route pedestrian	3.456	96.00	.02 RAL 7016	.1 1-10 V
	.ST street	3.456	96.00	.03 Matt Black	.D DALI

*Other light colors available on request: Neutral-white

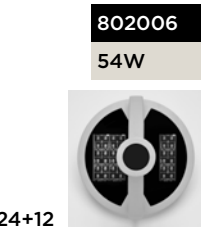

24+12

CCT*	Beam Angle	Im	Im/w	Finish	Dimming
.30 3000°K	.RT roto-symmetrical	5.184	96.00	.01 RAL 9006	.0 ON/OFF
	.CP cycle route pedestrian	5.184	96.00	.02 RAL 7016	.1 1-10 V
	.ST street	5.184	96.00	.03 Matt Black	.D DALI

*Other light colors available on request: Neutral-white

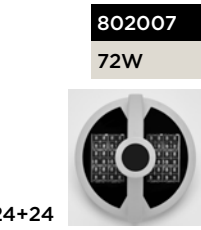

24+24

CCT*	Beam Angle	Im	Im/w	Finish	Dimming
.30 3000°K	.RT roto-symmetrical	6.912	96.00	.01 RAL 9006	.0 ON/OFF
	.CP cycle route pedestrian	6.912	96.00	.02 RAL 7016	.1 1-10 V
	.ST street	6.912	96.00	.03 Matt Black	.D DALI

*Other light colors available on request: Neutral-white

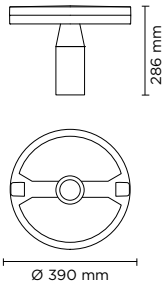

PRODUCT WEIGHT 6,10 kg



Code Example

802008.30.RT.01.0

Accessories p. 357

City 03

Round pole-top mounted luminaire for outdoor installation on a pole diam. 60 mm, central supporting arm, with downward light distribution. Phospho-chromatised and polyester powder coated die-cast copper-free aluminium body, tempered safety glass, moulded silicone gasket and stainless steel screws
Built-in LED driver/s, with 12 to 48 CREE XP-G3 LED. IP66 rating.

802008
18W

12+0

CCT*	Beam Angle	Im	Im/w	Finish	Dimming
.30 3000°K	.RT roto-symmetrical	1.728	96.00	.01 RAL 9006	.0 ON/OFF
	.CP cycle route pedestrian	1.728	96.00	.02 RAL 7016	.1 1-10 V
	.ST street	1.728	96.00	.03 Matt Black	.D DALI

*Other light colors available on request: Neutral-white

802009
36W

12+12

CCT*	Beam Angle	Im	Im/w	Finish	Dimming
.30 3000°K	.RT roto-symmetrical	3.456	96.00	.01 RAL 9006	.0 ON/OFF
	.CP cycle route pedestrian	3.456	96.00	.02 RAL 7016	.1 1-10 V
	.ST street	3.456	96.00	.03 Matt Black	.D DALI

*Other light colors available on request: Neutral-white

802010
36W

24+0

CCT*	Beam Angle	Im	Im/w	Finish	Dimming
.30 3000°K	.RT roto-symmetrical	3.456	96.00	.01 RAL 9006	.0 ON/OFF
	.CP cycle route pedestrian	3.456	96.00	.02 RAL 7016	.1 1-10 V
	.ST street	3.456	96.00	.03 Matt Black	.D DALI

*Other light colors available on request: Neutral-white

802011
54W

24+12

CCT*	Beam Angle	Im	Im/w	Finish	Dimming
.30 3000°K	.RT roto-symmetrical	5.184	96.00	.01 RAL 9006	.0 ON/OFF
	.CP cycle route pedestrian	5.184	96.00	.02 RAL 7016	.1 1-10 V
	.ST street	5.184	96.00	.03 Matt Black	.D DALI

*Other light colors available on request: Neutral-white

802012
72W

24+24

CCT*	Beam Angle	Im	Im/w	Finish	Dimming
.30 3000°K	.RT roto-symmetrical	6.912	96.00	.01 RAL 9006	.0 ON/OFF
	.CP cycle route pedestrian	6.912	96.00	.02 RAL 7016	.1 1-10 V
	.ST street	6.912	96.00	.03 Matt Black	.D DALI

*Other light colors available on request: Neutral-white

ACCESSORIES NOT INCLUDED

Accessories to be ordered separately.

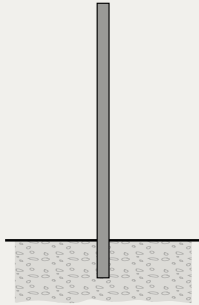
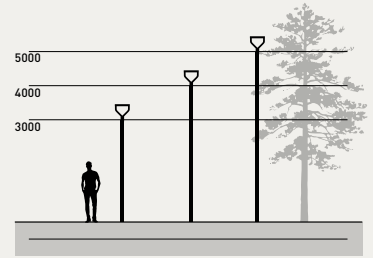

BURIED POLES

code	article	h. mm.	description
809901	cylindrical pole 3,5 meters to be buried	3.500	Cylindrical pole made in steel S235JR (UNI EN 10219) hot galvanized (UNI EN 1461), diameter 76 mm, thickness 4 mm.
809902	cylindrical pole 4,5 meters to be buried	4.500	Phospho-chromatised and polyester powder coated.
809903	cylindrical pole 5,5 meters to be buried	5.500	Total height including 500 mm to be buried into the ground. Includes IP54 cover plate 132x38 mm and terminal block in double insulation.
809908	adapter diam. 76mm -> 60mm		Adapter for pole diam. 76 mm, allow the diameter reduction to 60 mm

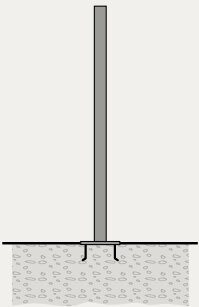

POLES WITH BASE-PLATE

code	article	h. mm.	description
809904	cylindrical pole 3 meters with base-plate	3.000	Cylindrical pole made in steel S235JR (UNI EN 10219) hot galvanized (UNI EN 1461), diameter 76 mm, thickness 4 mm.
809905	cylindrical pole 4 meters with base-plate	4.000	Phospho-chromatised and polyester powder coated.
809906	cylindrical pole 5 meters with base-plate	5.000	With base plate dim. 250x250 mm, thickness 10 mm Includes IP54 cover plate 132x38 mm and terminal block in double insulation.
809907	anchorage unit for base-plate		Base plate dim. 250x250 mm, thickness 3 mm, made in galvanized steel complete of nr. 4 anchorage threaded bolts
809908	adapter diam. 76mm -> 60mm		Adapter for pole diam. 76 mm, allow the diameter reduction to 60 mm

ROTSYMMETRICAL



CYCLE ROUTE / PEDESTRIAN



STREET

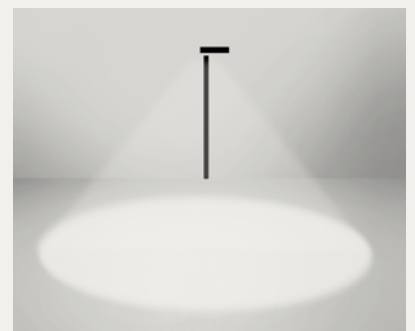



Zeus Pole

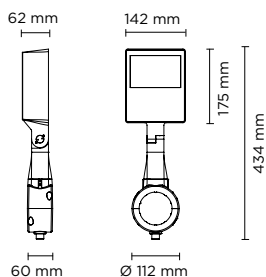

SYMMETRIC LIGHT DISTRIBUTION



ASYMMETRIC LIGHT DISTRIBUTION

PRODUCT WEIGHT 2,70 kg



Code Example

806005.30.DF.01.0

Accessories p. 361

Single Zeus Pole Medium

Square pole mounted floodlight for outdoor installation on a pole diam. 60 mm or 76 mm. Phospho-chromatised and polyester powder coated die-cast copper-free aluminium base and head, tempered safety glass, moulded silicone gaskets and o-rings, with screws in stainless steel.

Symmetrical or asymmetrical wide light distribution. Swivel joint with graduated scale and mechanical aiming lock. Built-in LED driver, with 56 x mid-power SAMSUNG 2835 LED. IP66 rating.



806005
20W

CCT	Beam Angle	lm	lm/w
.30 3000°K	.DF 110°	1.510	75.50
.40 4000°K	.DF 110°	1.560	78.00

Finish	Dimming
.01 RAL 9006	.0 ON/OFF
.02 RAL 7016	.1 1-10 V
.03 Matt Black	.D DALI



806006
20W

CCT	Beam Angle	lm	lm/w
.30 3000°K	.AS 110°X70°	1.560	78.00
.40 4000°K	.AS 110°X70°	1.610	80.50

Finish	Dimming
.01 RAL 9006	.0 ON/OFF
.02 RAL 7016	.1 1-10 V
.03 Matt Black	.D DALI

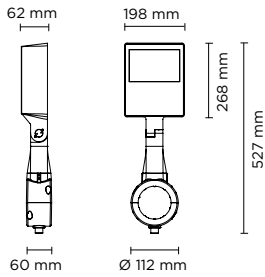

PRODUCT WEIGHT 4,00 kg



Code Example

806007 .30 .DF .01 .0

Accessories p. 361

Single Zeus Pole Maxi

Square pole mounted floodlight for outdoor installation on a pole diam. 60 mm or 76 mm. Phospho-chromatised and polyester powder coated die-cast copper-free aluminium base and head, tempered safety glass, moulded silicone gaskets and o-rings, with screws in stainless steel. Symmetrical or asymmetrical wide light distribution. Swivel joint with graduated scale and mechanical aiming lock. Built-in LED driver, with 120 x mid-power SAMSUNG 2835 LED. IP66 rating.



806007

42W

CCT	Beam Angle	lm	lm/w	Finish	Dimming
.30 3000°K	.DF 110°	3.900	92.86	.01 RAL 9006	.0 ON/OFF
.40 4000°K	.DF 110°	3.940	93.80	.02 RAL 7016	.1 1-10 V
				.03 Matt Black	.D DALI

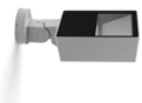

806008

42W

CCT	Beam Angle	lm	lm/w	Finish	Dimming
.30 3000°K	.AS 110°X70°	2.995	71.31	.01 RAL 9006	.0 ON/OFF
.40 4000°K	.AS 110°X70°	3.010	71.67	.02 RAL 7016	.1 1-10 V
				.03 Matt Black	.D DALI

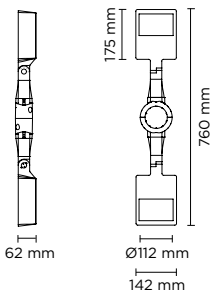

PRODUCT WEIGHT 5,00 kg



Code Example

806009 .30 .DF .01 .0

Accessories p. 361

Double Zeus Pole Medium

2 x Square pole mounted floodlight for outdoor installation on a pole diam. 60 mm or 76 mm. Phospho-chromatised and polyester powder coated die-cast copper-free aluminium base and head, tempered safety glass, moulded silicone gaskets and o-rings, with screws in stainless steel. Symmetrical or asymmetrical wide light distribution. Swivel joint with graduated scale and mechanical aiming lock. Built-in LED driver, with 56 x mid-power SAMSUNG 2835 LED. IP66 rating.



806009

2x20W

CCT	Beam Angle	lm	lm/w	Finish	Dimming
.30 3000°K	.DF 110°	2x1.510	75.50	.01 RAL 9006	.0 ON/OFF
.40 4000°K	.DF 110°	2x1.560	78.00	.02 RAL 7016	.1 1-10 V
				.03 Matt Black	.D DALI

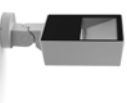

806010

2x20W

CCT	Beam Angle	lm	lm/w	Finish	Dimming
.30 3000°K	.AS 110°X70°	2x1.560	78.00	.01 RAL 9006	.0 ON/OFF
.40 4000°K	.AS 110°X70°	2x1.610	80.50	.02 RAL 7016	.1 1-10 V
				.03 Matt Black	.D DALI

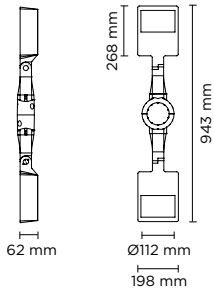

PRODUCT WEIGHT 7,50 kg
 DALI 1-10V IP66 IK09 CE 5 YEARS

Double Zeus Pole Maxi

Code Example

806011 .30 .DF .01 .0

Accessories p. 361

2 x Square pole mounted floodlight for outdoor installation on a pole diam. 60 mm or 76 mm. Phospho-chromatised and polyester powder coated die-cast copper-free aluminium base and head, tempered safety glass, moulded silicone gaskets and o-rings, with screws in stainless steel. Symmetrical or asymmetrical wide light distribution. Swivel joint with graduated scale and mechanical aiming lock. Built-in LED driver, with 120 x mid-power SAMSUNG 2835 LED. IP66 rating.



CCT	Beam Angle	lm	lm/w
.30 3000°K	.DF 110°	2x3.900	92.86
.40 4000°K	.DF 110°	2x3.940	93.80

Finish	Dimming
.01 RAL 9006	.0 ON/OFF
.02 RAL 7016	.1 1-10 V
.03 Matt Black	.D DALI

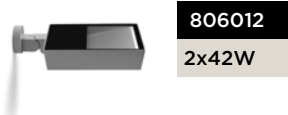

CCT	Beam Angle	lm	lm/w
.30 3000°K	.AS 110°X70°	2x2.995	71.31
.40 4000°K	.AS 110°X70°	2x3.010	71.67

Finish	Dimming
.01 RAL 9006	.0 ON/OFF
.02 RAL 7016	.1 1-10 V
.03 Matt Black	.D DALI

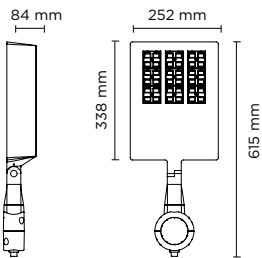

PRODUCT WEIGHT 5,50 kg
 DALI 1-10V IP66 IK09 CE 5 YEARS

Single Zeus Pole 36-48

Code Example

806001 .30 .CP .01 .0

Accessories p. 361

Square pole mounted floodlight for outdoor installation on a pole diam. 60 mm or 76 mm. Phospho-chromatised and polyester powder coated die-cast copper-free aluminium body, tempered safety glass, moulded silicone gasket and stainless steel screws. Flange for pole diam. 60 mm or 76 mm included. Built-in LED driver 220-240V 50-60Hz, with 36 or 48 CREE XP-G2 LED. IP66 rating.

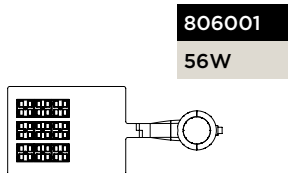

CCT	Beam Angle	lm	lm/w
.30 3000°K	.CP cycle route pedestrian	4.888	87.28
	.ST street	4.888	87.28
.40 4000°K	.CP cycle route pedestrian	5.040	90.00
	.ST street	5.040	90.00

Finish	Dimming
.01 RAL 9006	.0 ON/OFF
.02 RAL 7016	.1 1-10 V
.03 Matt Black	.D DALI

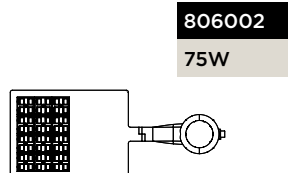

CCT	Beam Angle	lm	lm/w
.30 3000°K	.CP cycle route pedestrian	6.474	86.33
	.ST street	6.474	86.33
.40 4000°K	.CP cycle route pedestrian	6.675	89.00
	.ST street	6.675	89.00

Finish	Dimming
.01 RAL 9006	.0 ON/OFF
.02 RAL 7016	.1 1-10 V
.03 Matt Black	.D DALI

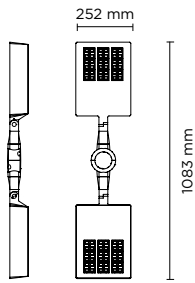

PRODUCT WEIGHT 10,50 kg



Code Example

806003.30.CP.01.0

Accessories p. 361

Double Zeus Pole 36-48

2 x square pole mounted floodlight for outdoor installation on a pole diam. 60 mm or 76 mm. Phospho-chromatised and polyester powder coated die-cast copper-free aluminium body, tempered safety glass, moulded silicone gasket and stainless steel screws. Flange for pole diam. 60 mm or 76 mm included. Built-in LED driver 220-240V 50-60Hz, with 2x36 or 2x48 CREE XP-G2 LED. IP66 rating.

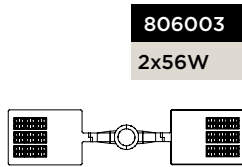

806003

2x56W

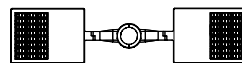

806004

2x75W

CCT	Beam Angle	Im	lm/w	Finish	Dimming
.30 3000°K	.CP cycle route pedestrian	2x4.888	87.28	.01 RAL 9006	.0 ON/OFF
	.ST street	2x4.888	87.28	.02 RAL 7016	.1 1-10 V
.40 4000°K	.CP cycle route pedestrian	2x5.040	90.00	.03 Matt Black	.D DALI
	.ST street	2x5.040	90.00		

CCT	Beam Angle	Im	lm/w	Finish	Dimming
.30 3000°K	.CP cycle route pedestrian	2x6.474	86.33	.01 RAL 9006	.0 ON/OFF
	.ST street	2x6.474	86.33	.02 RAL 7016	.1 1-10 V
.40 4000°K	.CP cycle route pedestrian	2x6.675	89.00	.03 Matt Black	.D DALI
	.ST street	2x6.675	89.00		

ACCESSORIES NOT INCLUDED

Accessories to be ordered separately.

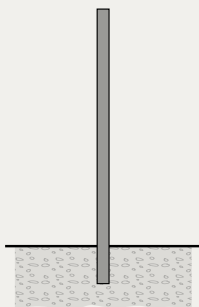

BURIED POLES

code	article	h. mm.	description
809901	cylindrical pole 3,5 meters to be buried	3.500	Cylindrical pole made in steel S235JR (UNI EN 10219) hot galvanized (UNI EN 1461), diameter 76 mm, thickness 4 mm.
809902	cylindrical pole 4,5 meters to be buried	4.500	Phospho-chromatised and polyester powder coated. Total height including 500 mm to be buried into the ground. Includes IP54 cover plate 132x38 mm and terminal block in double insulation.
809903	cylindrical pole 5,5 meters to be buried	5.500	Phospho-chromatised and polyester powder coated. Total height including 500 mm to be buried into the ground. Includes IP54 cover plate 132x38 mm and terminal block in double insulation.
809909	Top cap for pole diam. 76 mm.		

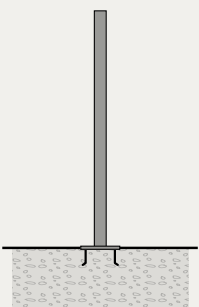

POLES WITH BASE-PLATE

code	article	h. mm.	description
809904	cylindrical pole 3 meters with base-plate	3.000	Cylindrical pole made in steel S235JR (UNI EN 10219) hot galvanized (UNI EN 1461), diameter 76 mm, thickness 4 mm.
809905	cylindrical pole 4 meters with base-plate	4.000	Phospho-chromatised and polyester powder coated. With base plate dim. 250x250 mm, thickness 10 mm Includes IP54 cover plate 132x38 mm and terminal block in double insulation.
809906	cylindrical pole 5 meters with base-plate	5.000	Phospho-chromatised and polyester powder coated. With base plate dim. 250x250 mm, thickness 10 mm Includes IP54 cover plate 132x38 mm and terminal block in double insulation.
809907	anchorage unit for base-plate		Base plate dim. 250x250 mm, thickness 3 mm, made in galvanized steel complete of nr. 4 anchorage threaded bolts
809909	Top cap for pole diam. 76 mm.		



Book Pole Top

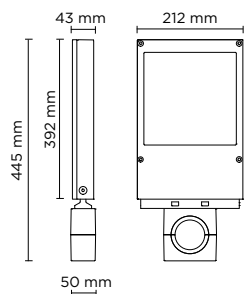

PRODUCT WEIGHT 3,00 kg

Code Example

803001 .30 .CP .01 .0

Accessories p. 363

Single Book Pole Top Maxi

Square pole-top mounted floodlight for outdoor installation on a pole diam. 60 mm or 76 mm. Phospho-chromatised and polyester powder coated die-cast copper-free aluminium body, tempered safety glass, moulded silicone gasket and stainless steel screws. Flange for pole diam. 60 mm or 76 mm included. Built-in LED driver 220-240V 50-60Hz, with 12 or 24 CREE XP-G3 LED. IP65 rating.



CCT*	Beam Angle	lm	lm/w	Finish	Dimming
.30 3000°K	.CP cycle route pedestrian	1.728	96.00	.01 RAL 9006	.0 ON/OFF
		1.728	96.00	.02 RAL 7016	.1 1-10 V
	.ST street			.03 Matt Black	.D DALI

*Other light colors available on request: Neutral-white

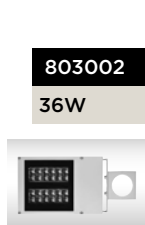

CCT*	Beam Angle	lm	lm/w	Finish	Dimming
.30 3000°K	.CP cycle route pedestrian	3.456	96.00	.01 RAL 9006	.0 ON/OFF
		3.456	96.00	.02 RAL 7016	.1 1-10 V
	.ST street			.03 Matt Black	.D DALI

*Other light colors available on request: Neutral-white

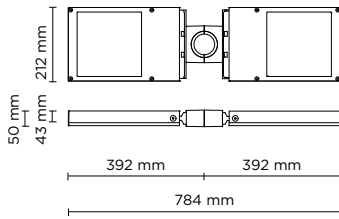

PRODUCT WEIGHT 5,80 kg



Code Example

803003.30.CP.01.0

Accessories p. 363

Double Book Pole Top Maxi

2 x square pole-top mounted floodlight for outdoor installation on a pole diam. 60 mm or 76 mm. Phospho-chromatised and polyester powder coated die-cast copper-free aluminium body, tempered safety glass, moulded silicone gasket and stainless steel screws. Flange for pole diam. 60 mm or 76 mm included. Built-in LED driver 220-240V 50-60Hz, with 2 x 12 or 24 CREE XP-G3 LED. IP65 rating.

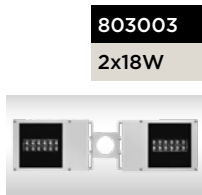

803003
2x18W

CCT*	Beam Angle	Im	lm/w	Finish	Dimming
.30 3000°K	.CP cycle route pedestrian	2x1.728	96.00	.01 RAL 9006	.0 ON/OFF
	.ST street	2x1.728	96.00	.02 RAL 7016	.1 1-10 V
				.03 Matt Black	.D DALI

*Other light colors available on request: Neutral-white

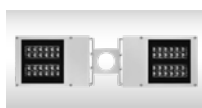

803004
2x36W

CCT*	Beam Angle	Im	lm/w	Finish	Dimming
.30 3000°K	.CP cycle route pedestrian	2x3.456	96.00	.01 RAL 9006	.0 ON/OFF
	.ST street	2x3.456	96.00	.02 RAL 7016	.1 1-10 V
				.03 Matt Black	.D DALI

*Other light colors available on request: Neutral-white

ACCESSORIES NOT INCLUDED

Accessories to be ordered separately.

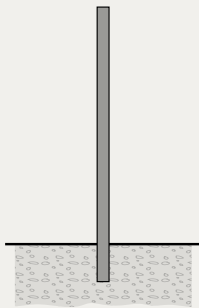

BURIED POLES

code	article	h. mm.	description
809901	cylindrical pole 3,5 meters to be buried	3.500	Cylindrical pole made in steel S235JR (UNI EN 10219) hot galvanized (UNI EN 1461), diameter 76 mm, thickness 4 mm.
809902	cylindrical pole 4,5 meters to be buried	4.500	Phospho-chromatised and polyester powder coated. Total height including 500 mm to be buried into the ground. Includes IP54 cover plate 132x38 mm and terminal block in double insulation.
809903	cylindrical pole 5,5 meters to be buried	5.500	Phospho-chromatised and polyester powder coated. Total height including 500 mm to be buried into the ground. Includes IP54 cover plate 132x38 mm and terminal block in double insulation.
809909	Top cap for pole diam. 76 mm.		

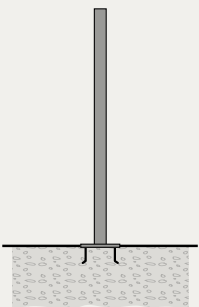

POLES WITH BASE-PLATE

code	article	h. mm.	description
809904	cylindrical pole 3 meters with base-plate	3.000	Cylindrical pole made in steel S235JR (UNI EN 10219) hot galvanized (UNI EN 1461), diameter 76 mm, thickness 4 mm.
809905	cylindrical pole 4 meters with base-plate	4.000	Phospho-chromatised and polyester powder coated. With base plate dim. 250x250 mm, thickness 10 mm Includes IP54 cover plate 132x38 mm and terminal block in double insulation.
809906	cylindrical pole 5 meters with base-plate	5.000	Phospho-chromatised and polyester powder coated. With base plate dim. 250x250 mm, thickness 10 mm Includes IP54 cover plate 132x38 mm and terminal block in double insulation.
809907	anchorage unit for base-plate		Base plate dim. 250x250 mm, thickness 3 mm, made in galvanized steel complete of nr. 4 anchorage threaded bolts
809909	Top cap for pole diam. 76 mm.		



Ring Pole

Nava + Arosio

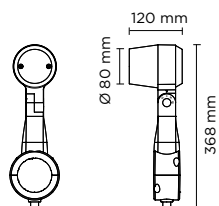

PRODUCT WEIGHT 2,00 kg

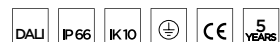

Code Example

807001.27.14.01.0

Accessories p. 374

Ring Pole Mini COB - Single

Floodlight for outdoor installation on a pole diam. 60 mm or 76 mm, with 355° swivel pole attachment and allowing horizontal adjustment of +90° / -40°. Phospho-chromatised and polyester powder coated die-cast copper-free aluminium base and head, tempered safety glass, moulded silicone gaskets and o-rings, with screws in stainless steel. Swivel pole joint with graduated scale and mechanical aiming lock. Built-in LED driver, with 1 COB CREE "CXB 1310" LED. IP66 rating.

807001

10W

CCT	Beam Angle	lm	lm/w	Finish	Dimming
.27 2700°K	.14 14°	1.045	104.50	.01 RAL 9006	.0 ON/OFF
	.35 35°	1.007	100.70	.02 RAL 7016	.D DALI
	.55 55°	950	95.00	.03 RAL 9005	
.30 3000°K	.14 14°	1.100	110.00		
	.35 35°	1.060	106.00		
	.55 55°	1.000	100.00		
.40 4000°K	.14 14°	1.200	120.00		
	.35 35°	1.140	114.00		
	.55 55°	1.083	108.00		

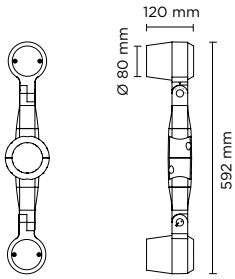

PRODUCT WEIGHT 3,50 kg

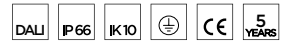

Ring Pole Mini COB - Double

Code Example

807004.27.14.01.0

Accessories p. 374

Floodlight for outdoor installation on a pole diam. 60 mm or 76 mm, with 355° swivel pole attachment and allowing horizontal adjustment of +90° / -40°. Phospho-chromatised and polyester powder coated die-cast copper-free aluminium base and head, tempered safety glass, moulded silicone gaskets and o-rings, with screws in stainless steel. Swivel pole joint with graduated scale and mechanical aiming lock. Built-in LED driver, with 1 COB CREE "CXB 1310" LED. IP66 rating.

807004

2x10W

CCT	Beam Angle	lm	lm/w	Finish	Dimming
.27 2700°K	.14 14°	2x1.045	104.50	.01 RAL 9006	.0 ON/OFF
	.35 35°	2x1.007	100.70	.02 RAL 7016	.D DALI
	.55 55°	2x950	95.00	.03 RAL 9005	
.30 3000°K	.14 14°	2x1.100	110.00		
	.35 35°	2x1.060	106.00		
	.55 55°	2x1.000	100.00		
.40 4000°K	.14 14°	2x1.200	120.00		
	.35 35°	2x1.140	114.00		
	.55 55°	2x1.083	108.00		

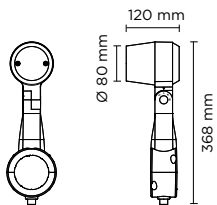

PRODUCT WEIGHT 2,00 kg

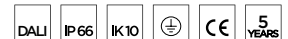

Ring Pole Mini HP - Single

Code Example

807007.27.04.01.0

Accessories p. 374

Floodlight for outdoor installation on a pole diam. 60 mm or 76 mm, with 355° swivel pole attachment and allowing horizontal adjustment of +90° / -40°. Phospho-chromatised and polyester powder coated die-cast copper-free aluminium base and head, tempered safety glass, moulded silicone gaskets and o-rings, with screws in stainless steel. Swivel pole joint with graduated scale and mechanical aiming lock. Built-in LED driver, with 1 x CREE XHP35 LED. IP66 rating.

807007

8W

CCT	Beam Angle	lm	lm/w	Finish	Dimming
.27 2700°K	.04 4°	655	81.87	.01 RAL 9006	.0 ON/OFF
	.10 10°	629	78.62	.02 RAL 7016	.D DALI
	.28 28°	610	76.25	.03 RAL 9005	
	.55 55°	519	64.87		
.30 3000°K	.04 4°	690	86.25		
	.10 10°	662	82.75		
	.28 28°	642	80.25		
	.55 55°	546	68.21		
.40 4000°K	.04 4°	703	87.88		
	.10 10°	676	84.50		
	.28 28°	656	82.00		
	.55 55°	558	69.70		

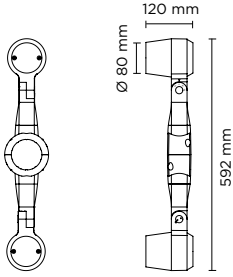

PRODUCT WEIGHT 3,50 kg

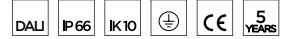

Ring Pole Mini HP - Double

Code Example

807010.27.04.01.0

Accessories p. 374

Floodlight for outdoor installation on a pole diam. 60 mm or 76 mm, with 355° swivel pole attachment and allowing horizontal adjustment of +90° / -40°. Phospho-chromatised and polyester powder coated die-cast copper-free aluminium base and head, tempered safety glass, moulded silicone gaskets and o-rings, with screws in stainless steel. Swivel pole joint with graduated scale and mechanical aiming lock. Built-in LED driver, with 1 x CREE XHP35 LED. IP66 rating.

807010

2x8W

CCT	Beam Angle	lm	lm/w	Finish	Dimming
.27 2700°K	.04 4°	2x655	81.87	.01 RAL 9006	.0 ON/OFF
	.10 10°	2x629	78.62	.02 RAL 7016	.D DALI
	.28 28°	2x610	76.25	.03 RAL 9005	
	.55 55°	2x519	64.87		
.30 3000°K	.04 4°	2x690	86.25		
	.10 10°	2x662	82.75		
	.28 28°	2x642	80.25		
	.55 55°	2x546	68.21		
.40 4000°K	.04 4°	2x703	87.88		
	.10 10°	2x676	84.50		
	.28 28°	2x656	82.00		
	.55 55°	2x558	69.70		

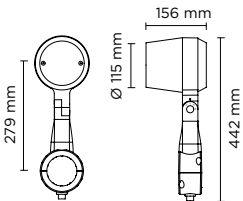

PRODUCT WEIGHT 3,00 kg



Ring Pole Medium COB - Single

Code Example

807002.27.14.01.0

Accessories p. 374

Floodlight for outdoor installation on a pole diam. 60 mm or 76 mm, with 355° swivel pole attachment and allowing horizontal adjustment of +90° / -40°. Phospho-chromatised and polyester powder coated die-cast copper-free aluminium base and head, tempered safety glass, moulded silicone gaskets and o-rings, with screws in stainless steel. Swivel pole joint with graduated scale and mechanical aiming lock. Built-in LED driver, with 1 COB CREE "CXB 1512" LED. IP66 rating.

807002

16W

CCT	Beam Angle	lm	lm/w	Finish	Dimming
.27 2700°K	.14 14°	1.805	112.81	.01 RAL 9006	.0 ON/OFF
	.35 35°	1.722	107.62	.02 RAL 7016	.1 1-10 V
	.55 55°	1.636	102.25	.03 RAL 9005	.D DALI
.30 3000°K	.14 14°	1.900	118.75		
	.35 35°	1.813	113.31		
	.55 55°	1.722	107.62		
.40 4000°K	.14 14°	2.000	125.00		
	.35 35°	1.900	118.75		
	.55 55°	1.805	112.81		

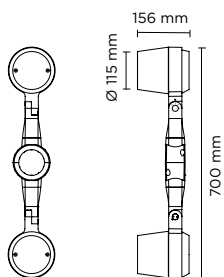

PRODUCT WEIGHT 5,50 kg



Code Example

807005.27.14.01.0

Accessories p. 374

Ring Pole Medium COB - Double

Floodlight for outdoor installation on a pole diam. 60 mm or 76 mm, with 355° swivel pole attachment and allowing horizontal adjustment of +90° / -40°. Phospho-chromatised and polyester powder coated die-cast copper-free aluminium base and head, tempered safety glass, moulded silicone gaskets and o-rings, with screws in stainless steel. Swivel pole joint with graduated scale and mechanical aiming lock. Built-in LED driver, with 1 x CREE XHP35 LED. IP66 rating.

807005

2x16W

CCT	Beam Angle	lm	lm/w	Finish	Dimming
.27 2700°K	.14 14°	2x1.805	112.81	.01 RAL 9006	.0 ON/OFF
	.35 35°	2x1.722	107.62	.02 RAL 7016	.1 1-10 V
	.55 55°	2x1.636	102.25	.03 RAL 9005	.D DALI
.30 3000°K	.14 14°	2x1.900	118.75		
	.35 35°	2x1.813	113.31		
	.55 55°	2x1.722	107.62		
.40 4000°K	.14 14°	2x2.000	125.00		
	.35 35°	2x1.900	118.75		
	.55 55°	2x1.805	112.81		

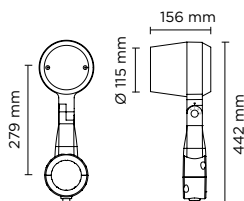

PRODUCT WEIGHT 3,00 kg



Code Example

807008.27.04.01.0

Accessories p. 374

Ring Pole Medium HP - Single

Floodlight for outdoor installation on a pole diam. 60 mm or 76 mm, with 355° swivel pole attachment and allowing horizontal adjustment of +90° / -40°. Phospho-chromatised and polyester powder coated die-cast copper-free aluminium base and head, tempered safety glass, moulded silicone gaskets and o-rings, with screws in stainless steel. Swivel pole joint with graduated scale and mechanical aiming lock. Built-in LED driver, with 3 x CREE XHP35 LED. IP66 rating.

807008

20W

CCT	Beam Angle	lm	lm/w	Finish	Dimming
.27 2700°K	.04 4°	1.947	97.35	.01 RAL 9006	.0 ON/OFF
	.10 10°	1.900	95.00	.02 RAL 7016	.1 1-10 V
	.28 28°	1.852	92.60	.03 RAL 9005	.D DALI
	.55 55°	1.575	78.75		
.30 3000°K	.04 4°	2.050	102.50		
	.10 10°	2.000	100.00		
	.28 28°	1.950	97.50		
	.55 55°	1.658	82.88		
.40 4000°K	.04 4°	2.100	105.00		
	.10 10°	2.050	102.50		
	.28 28°	2.000	100.00		
	.55 55°	1.700	85.00		

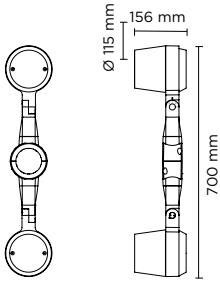

PRODUCT WEIGHT 5,50 kg



Code Example

807011.27.04.01.0

Accessories p. 374

Ring Pole Medium HP - Double

Floodlight for outdoor installation on a pole diam. 60 mm or 76 mm, with 355° swivel pole attachment and allowing horizontal adjustment of +90° / -40°. Phospho-chromatised and polyester powder coated die-cast copper-free aluminium base and head, tempered safety glass, moulded silicone gaskets and o-rings, with screws in stainless steel. Swivel pole joint with graduated scale and mechanical aiming lock. Built-in LED driver, with 3 x CREE XHP35 LED. IP66 rating.

807011

2x20W

CCT	Beam Angle	lm	lm/w	Finish	Dimming
.27 2700°K	.04 4°	2x1.947	97.35	.01 RAL 9006	.0 ON/OFF
	.10 10°	2x1.900	95.00	.02 RAL 7016	.1 1-10 V
	.28 28°	2x1.852	92.60		.D DALI
	.55 55°	2x1.575	78.75		
.30 3000°K	.04 4°	2x2.050	102.50	.03 RAL 9005	
	.10 10°	2x2.000	100.00		
	.28 28°	2x1.950	97.50		
	.55 55°	2x1.658	82.88		
.40 4000°K	.04 4°	2x2.100	105.00		
	.10 10°	2x2.050	102.50		
	.28 28°	2x2.000	100.00		
	.55 55°	2x1.700	85.00		

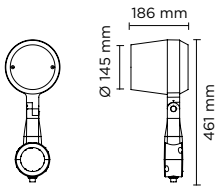

PRODUCT WEIGHT 4,50 kg



Code Example

807003.27.14.01.0

Accessories p. 374

Ring Pole Maxi Cob - Single

Floodlight for outdoor installation on a pole diam. 60 mm or 76 mm, with 355° swivel pole attachment and allowing horizontal adjustment of +90° / -40°. Phospho-chromatised and polyester powder coated die-cast copper-free aluminium base and head, tempered safety glass, moulded silicone gaskets and o-rings, with screws in stainless steel. Swivel pole joint with graduated scale and mechanical aiming lock. Built-in LED driver, with 1 COB CREE "CXB 2540" LED. IP66 rating.

807003

42W

CCT	Beam Angle	lm	lm/w	Finish	Dimming
.27 2700°K	.14 14°	4.702	111.95	.01 RAL 9006	.0 ON/OFF
	.35 35°	4.514	107.48		
	.55 55°	4.332	103.14		
.30 3000°K	.14 14°	4.950	117.85	.02 RAL 7016	.1 1-10 V
	.35 35°	4.752	113.14		
	.55 55°	4.560	108.57		
.40 4000°K	.14 14°	5.265	125.36	.03 RAL 9005	.D DALI
	.35 35°	5.000	119.05		
	.55 55°	4.770	113.57		

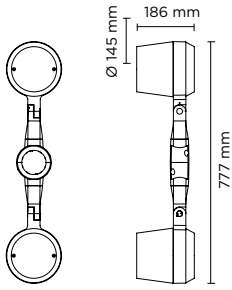

PRODUCT WEIGHT 8,50 kg



Code Example

807006.27.14.01.0

Accessories p. 374

Ring Pole Maxi Cob - Double

Floodlight for outdoor installation on a pole diam. 60 mm or 76 mm, with 355° swivel pole attachment and allowing horizontal adjustment of +90° / -40°. Phospho-chromatised and polyester powder coated die-cast copper-free aluminium base and head, tempered safety glass, moulded silicone gaskets and o-rings, with screws in stainless steel. Swivel pole joint with graduated scale and mechanical aiming lock. Built-in LED driver, with 1 COB CREE "CXB 2540" LED. IP66 rating.

807006

2x42W

CCT	Beam Angle	lm	lm/w	Finish	Dimming
.27 2700°K	.14 14°	2x4.702	111.95	.01 RAL 9006	.0 ON/OFF
	.35 35°	2x4.514	107.48	.02 RAL 7016	.1 1-10 V
	.55 55°	2x4.332	103.14	.03 RAL 9005	.D DALI
.30 3000°K	.14 14°	2x4.950	117.85		
	.35 35°	2x4.752	113.14		
	.55 55°	2x4.560	108.57		
.40 4000°K	.14 14°	2x5.265	125.36		
	.35 35°	2x5.000	119.05		
	.55 55°	2x4.770	113.57		

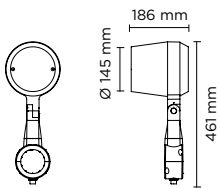

PRODUCT WEIGHT 4,50 kg



Code Example

807009.27.04.01.0

Accessories p. 374

Ring Pole Maxi HP - Single

Floodlight for outdoor installation on a pole diam. 60 mm or 76 mm, with 355° swivel pole attachment and allowing horizontal adjustment of +90° / -40°. Phospho-chromatised and polyester powder coated die-cast copper-free aluminium base and head, tempered safety glass, moulded silicone gaskets and o-rings, with screws in stainless steel. Swivel pole joint with graduated scale and mechanical aiming lock. Built-in LED driver, with 6 x CREE XHP35 LED. IP66 rating.

807009

38W

CCT	Beam Angle	lm	lm/w	Finish	Dimming
.27 2700°K	.04 4°	4.085	107.50	.01 RAL 9006	.0 ON/OFF
	.10 10°	4.047	106.50	.02 RAL 7016	.1 1-10 V
	.28 28°	3.999	105.24	.03 RAL 9005	.D DALI
	.55 55°	3.400	89.47		
.30 3000°K	.04 4°	4.300	113.15		
	.10 10°	4.260	112.10		
	.28 28°	4.210	110.79		
	.55 55°	3.579	94.17		
.40 4000°K	.04 4°	4.400	115.79		
	.10 10°	4.360	114.74		
	.28 28°	4.310	113.42		
	.55 55°	3.664	96.41		

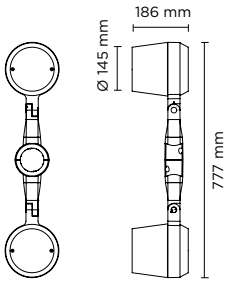

PRODUCT WEIGHT 8,50 kg



Code Example

807012 .27 .04 .01 .0

Accessories p. 374

Ring Pole Maxi HP - Double

Floodlight for outdoor installation on a pole diam. 60 mm or 76 mm, with 355° swivel pole attachment and allowing horizontal adjustment of +90° / -40°. Phospho-chromatised and polyester powder coated die-cast copper-free aluminium base and head, tempered safety glass, moulded silicone gaskets and o-rings, with screws in stainless steel. Swivel pole joint with graduated scale and mechanical aiming lock. Built-in LED driver, with 6 x CREE XHP35 LED. IP66 rating.

807012

2x38W

CCT	Beam Angle	lm	lm/w	Finish	Dimming
.27 2700°K	.04 4°	2x4.085	107.50	.01 RAL 9006	.0 ON/OFF
	.10 10°	2x4.047	106.50	.02 RAL 7016	.1 1-10 V
	.28 28°	2x3.999	105.24	.03 RAL 9005	.D DALI
	.55 55°	2x3.400	89.47		
.30 3000°K	.04 4°	2x4.300	113.15		
	.10 10°	2x4.260	112.10		
	.28 28°	2x4.210	110.79		
	.55 55°	2x3.579	94.17		
.40 4000°K	.04 4°	2x4.400	115.79		
	.10 10°	2x4.360	114.74		
	.28 28°	2x4.310	113.42		
	.55 55°	2x3.664	96.41		

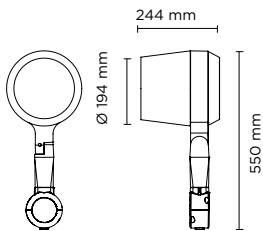

PRODUCT WEIGHT 8,50 kg

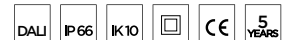

Code Example

807013 .27 .20 .01 .0

Accessories p. 374

Ring Pole Mega COB Single

Floodlight for outdoor installation on a pole diam. 60 mm or 76 mm, with 355° swivel pole attachment and allowing horizontal adjustment of +90° / -40°. Phospho-chromatised and polyester powder coated die-cast copper-free aluminium base and head, tempered safety glass, moulded silicone gaskets and o-rings, with screws in stainless steel. Swivel pole joint with graduated scale and mechanical aiming lock. Built-in LED driver, with 1 COB CREE "CXB 3590" LED. IP66 rating.

807013

75W

CCT	Beam Angle	lm	lm/w	Finish	Dimming
.27 2700°K	.20 20°	9.595	127.93	.01 RAL 9006	.0 ON/OFF
	.40 40°	9.519	126.92	.02 RAL 7016	.D DALI
.30 3000°K	.20 20°	10.100	123.17	.03 RAL 9005	
	.40 40°	10.020	122.20		
.40 4000°K	.20 20°	10.200	124.39		
	.40 40°	10.120	123.42		

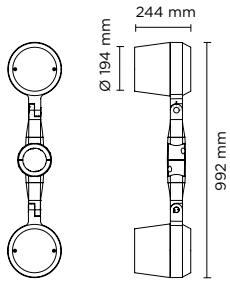

PRODUCT WEIGHT 16,50 kg

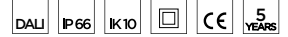

Code Example

807015 .27 .20 .01 .0

Accessories p. 374

Ring Pole Mega COB - Double

Floodlight for outdoor installation on a pole diam. 60 mm or 76 mm, with 355° swivel pole attachment and allowing horizontal adjustment of +90° / -40°. Phospho-chromatised and polyester powder coated die-cast copper-free aluminium base and head, tempered safety glass, moulded silicone gaskets and o-rings, with screws in stainless steel. Swivel pole joint with graduated scale and mechanical aiming lock. Built-in LED driver, with 1 COB CREE “CXB 3590” LED. IP66 rating.

CCT	Beam Angle	lm	lm/w	Finish	Dimming
807015 2x75W	.27 2700°K	.20 20°	2x9.595 127.93	.01 RAL 9006	.0 ON/OFF
		.40 40°	2x9.519 126.92	.02 RAL 7016	.D DALI
	.30 3000°K	.20 20°	2x10.100 123.17	.03 RAL 9005	
		.40 40°	2x10.200 122.20		
	.40 4000°K	.20 20°	2x10.200 124.39		
		.40 40°	2x10.120 123.42		



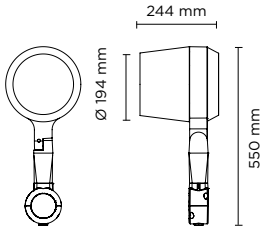

PRODUCT WEIGHT 8,50 kg

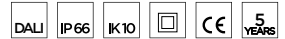

Ring Pole MEGA HP - Single

Code Example

807014 .27 .04 .01 .0

Accessories p. 374

Floodlight for outdoor installation on a pole diam. 60 mm or 76 mm, with 355° swivel pole attachment and allowing horizontal adjustment of +90° / -40°. Phospho-chromatised and polyester powder coated die-cast copper-free aluminium base and head, tempered safety glass, moulded silicone gaskets and o-rings, with screws in stainless steel. Swivel pole joint with graduated scale and mechanical aiming lock. Built-in LED driver, with 12 x CREE "XH-P 35" LED. IP66 rating.

807014

88W

CCT	Beam Angle	lm	lm/w	Finish	Dimming
.27 2700°K	.04 4°	9.025	102.56	.01 RAL 9006	.0 ON/OFF
	.10 10°	8.977	102.01	.02 RAL 7016	.D DALI
	.28 28°	8.911	101.26		
	.55 55°	7.574	86.07		
.30 3000°K	.04 4°	9.500	107.96	.03 RAL 9005	
	.10 10°	9.450	107.38		
	.28 28°	9.380	106.59		
	.55 55°	7.973	90.60		
.40 4000°K	.04 4°	9.600	109.09		
	.10 10°	9.550	108.52		
	.28 28°	9.480	107.73		
	.55 55°	8.058	91.57		



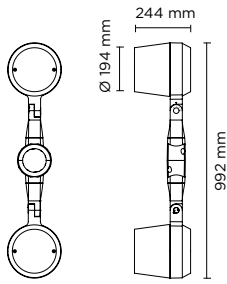

PRODUCT WEIGHT 16,50 kg



Ring Pole MEGA HP - Double

Code Example

807016.27.04.01.0

Accessories p. 374

Floodlight for outdoor installation on a pole diam. 60 mm or 76 mm, with 355° swivel pole attachment and allowing horizontal adjustment of +90° / -40°. Phospho-chromatised and polyester powder coated die-cast copper-free aluminium base and head, tempered safety glass, moulded silicone gaskets and o-rings, with screws in stainless steel. Swivel pole joint with graduated scale and mechanical aiming lock. Built-in LED driver, with 12 x CREE "XH-P 35" LED. IP66 rating.

	CCT	Beam Angle	lm	lm/w	Finish	Dimming	
807016 2x88W	.27 2700°K	.04 4°	2x9.025	102.56	.01 RAL 9006	.0 ON/OFF	
		.10 10°	2x8.977	102.01	.02 RAL 7016	.D DALI	
		.28 28°	2x8.911	101.26			
	.30 3000°K	.55 55°	2x7.574	86.07	.03 RAL 9005		
		.04 4°	2x9.500	107.96			
		.10 10°	2x9.450	107.38			
	.40 4000°K	.28 28°	2x9.380	106.59			
		.55 55°	2x7.973	90.60			
		.04 4°	2x9.600	109.09			
			.10 10°	2x9.550	108.52		
			.28 28°	2x9.480	107.73		
			.55 55°	2x8.058	91.57		

SOME APPLICATION EXAMPLES:



3 X RING MEGA
ON VARIOUS STAGGERED
LEVELS ON THE SAME POLE



4 X RING MEGA
ON VARIOUS STAGGERED
LEVELS ON THE SAME POLE

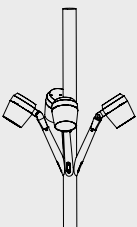

On a single level
Min. angle between
luminaire heads **80°**

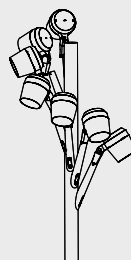
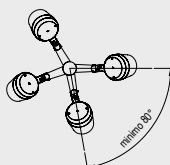

On various staggered levels
Min. angle between luminaire
heads **40°**

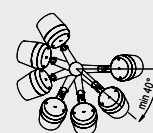

INTEGRATED ACCESSORIES

807001.27.14.01.0.---

Built-in accessories to be requested when ordering
example 807001.27.14.01.0.**PP**

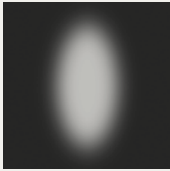

.EL

ELLIPTICAL GLASS

Elliptical diffusion lens to shape the light in a more directional and asymmetric way. Available for

- ALL RING **MINI** ITEMS
- ALL RING **MEDIUM** ITEMS
- ALL RING **MAXI** ITEM



.PS

PRISMATIC GLASS

Designed to ensure uniform light distribution and glare reduction.

- Available for
- ALL RING **MINI** ITEMS
 - ALL RING **MEDIUM** ITEMS
 - ALL RING **MAXI** ITEM

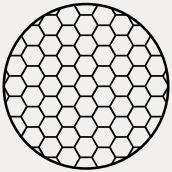

.HC

HONEYCOMB

A honeycomb structure designed to shield the light beam, reduce glare, and eliminate direct exposure to the light source.

Compatible for all products of the series.



.PP

POLE PLATE

Pole plate for pole mounting of all Ring models, suitable to be used with poles diam. min 76 mm and diam. max 120 mm. Can be positioned on various staggered levels or on a single level, with the same pole. Made in phospho-chromatised and polyester powder coated dia-cast copper-free aluminum material, moulded silicone gaskets and screws in stainless steel.

Compatible for all products of the series



.TB

TREE-BRANCH BRACKET

Special bracket for Ring Maxi pole mounting, suitable to be used with poles diam. min 76 mm and diam. max 120 mm. Can be positioned on various staggered levels or on a single level, with the same pole. Made in phospho-chromatised and polyester powder coated dia-cast copper-free aluminum material, moulded silicone gaskets and screws in stainless steel.

- Available for
- ALL RING **MAXI** ITEMS
 - ALL RING **MEGA** ITEMS

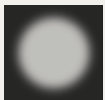

.HR

PRISMATIC + HONEYCOMB

- Available for
- ALL RING **MINI** ITEMS
 - ALL RING **MEDIUM** ITEMS
 - ALL RING **MAXI** ITEM



.PE

ELLIPTICAL + POLE PLATE

- Available for
- ALL RING **MINI** ITEMS
 - ALL RING **MEDIUM** ITEMS
 - ALL RING **MAXI** ITEM



.HE

ELLIPTICAL + HONEYCOMB

- Available for
- ALL RING **MINI** ITEMS
 - ALL RING **MEDIUM** ITEMS
 - ALL RING **MAXI** ITEM



.PR

PRISMATIC + POLE PLATE

- Available for
- ALL RING **MINI** ITEMS
 - ALL RING **MEDIUM** ITEMS
 - ALL RING **MAXI** ITEM



.HP
POLE PLATE + HONEYCOMB
 Compatible for all products of the series



.TP
TREE-BRANCH BRACKET + PRISMATIC
 Available for ALL RING **MAXI** ITEMS

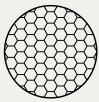

.TH
TREE-BRANCH BRACKET + HONEYCOMB
 Available for ALL RING **MAXI** ITEMS
 ALL RING **MEGA** ITEMS



.TE
TREE-BRANCH BRACKET + ELLIPTICAL
 Available for ALL RING **MAXI** ITEMS

ACCESSORIES NOT INCLUDED

Accessories to be ordered separately.

POLES

Full technical details of poles and accessories for poles are available at the end of the catalogue

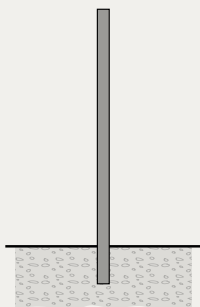

BURIED POLES

code	h. mm.
809901	3.500
809902	4.500
809903	5.500
809909	Top cap diam 76mm

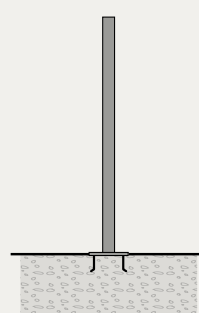

POLES WITH BASE-PLATE

code	h. mm.
809904	3.000
809905	4.000
809906	5.000
809907	Anchorage unit for base-plate
809909	Top cap diam 76mm



ANTI-GLARE VISOR

Minimizes glare and optimizes beam direction for precise lighting.

Available for:

AC045
 FOR ALL RING **MINI** ITEMS
AC046
 FOR ALL RING **MEDIUM** ITEMS

AC047
 FOR ALL RING **MAXI** ITEMS
AC086
 FOR ALL RING **MEGA** ITEMS



Qubo Pole

Nava + Arosio

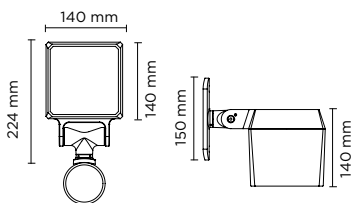

PRODUCT WEIGHT 3,50 kg



Qubo Medium Pole Cob

Code Example



808001 .27 .14 .01 .0

Accessories p. 378

Pole-mounted projector for outdoor installation on a pole; with U shape fixing bracket allowing vertical adjustment of +90° / -40°. Phospho-chromatised and polyester powder coated die-cast copper-free aluminium base and head, tempered safety glass, moulded silicone gaskets, with screws in stainless steel. Built-in LED driver. IP66 rating.

808001

16W

CCT	Beam Angle	lm	lm/w	Finish	Dimming
.27 2700°K	.14 14°	1.805	112.81	.01  RAL 9006	.0 ON/OFF
	.35 35°	1.722	107.62	.02  RAL 7016	.1 1-10 V
	.55 55°	1.636	102.25	.03  Matt Black	.D DALI
.30 3000°K	.14 14°	1.900	118.75		
	.35 35°	1.813	113.31		
	.55 55°	1.722	107.62		
.40 4000°K	.14 14°	2.000	125.00		
	.35 35°	1.900	118.75		
	.55 55°	1.805	112.81		

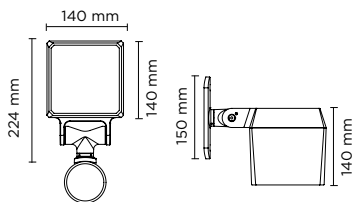

PRODUCT WEIGHT 3,50 kg



Qubo Medium Pole HP

Code Example

808003 .27 .04 .01 .0

Accessories p. 378

Pole-mounted projector for outdoor installation on a pole; with U shape fixing bracket allowing vertical adjustment of +90° / -40°. Phospho-chromatised and polyester powder coated die-cast copper-free aluminium base and head, tempered safety glass, moulded silicone gaskets, with screws in stainless steel. Built-in LED driver. IP66 rating.

808003
20W

CCT	Beam Angle	lm	lm/w	Finish	Dimming
.27 2700°K	.04 4°	1.947	97.35	.01 RAL 9006	.0 ON/OFF
	.10 10°	1.900	95.00	.02 RAL 7016	.1 1-10 V
	.28 28°	1.852	92.60	.03 Matt Black	.D DALI
	.55 55°	1.575	78.75		
.30 3000°K	.04 4°	2.050	102.50		
	.10 10°	2.000	100.00		
	.28 28°	1.950	97.50		
.40 4000°K	.04 4°	2.100	105.00		
	.10 10°	2.050	102.50		
	.28 28°	2.000	100.00		
	.55 55°	1.700	85.00		

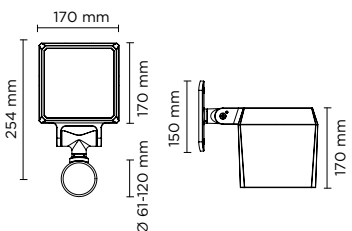

PRODUCT WEIGHT 4,90 kg



Qubo Maxi Pole COB

Code Example

808002 .27 .14 .01 .0

Accessories p. 378

Pole-mounted projector for outdoor installation on a pole; with U shape fixing bracket allowing vertical adjustment of +90° / -40°. Phospho-chromatised and polyester powder coated die-cast copper-free aluminium base and head, tempered safety glass, moulded silicone gaskets, with screws in stainless steel. Built-in LED driver. IP66 rating.

808002
42W

CCT	Beam Angle	lm	lm/w	Finish	Dimming
.27 2700°K	.14 14°	4.702	111.95	.01 RAL 9006	.0 ON/OFF
	.35 35°	4.514	107.48	.02 RAL 7016	.1 1-10 V
	.55 55°	4.332	103.14	.03 Matt Black	.D DALI
.30 3000°K	.14 14°	4.950	117.85		
	.35 35°	4.752	113.14		
	.55 55°	4.560	108.57		
.40 4000°K	.14 14°	5.265	125.36		
	.35 35°	5.000	119.05		
	.55 55°	4.770	113.57		

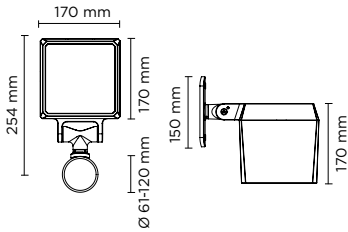

PRODUCT WEIGHT 4,90 kg



Qubo Maxi Pole HP

Pole-mounted projector for outdoor installation on a pole; with U shape fixing bracket allowing vertical adjustment of +90° / -40°. Phospho-chromatised and polyester powder coated die-cast copper-free aluminium base and head, tempered safety glass, moulded silicone gaskets, with screws in stainless steel. Built-in LED driver. IP66 rating.

Code Example

808004.27.04.01.0

Accessories p. 378

808004
38W

CCT	Beam Angle	lm	lm/w	Finish	Dimming
.27 2700°K	.04 4°	4.085	107.50	.01 RAL 9006	.0 ON/OFF
	.10 10°	4.047	106.50	.02 RAL 7016	.1 1-10 V
	.28 28°	3.999	105.24	.03 Matt Black	.D DALI
	.55 55°	2.958	77.84		
.30 3000°K	.04 4°	4.300	113.15		
	.10 10°	4.260	112.10		
	.28 28°	4.210	110.79		
	.55 55°	3.114	81.95		
.40 4000°K	.04 4°	4.400	115.79		
	.10 10°	4.360	114.74		
	.28 28°	4.310	113.42		
	.55 55°	3.664	96.41		

ACCESSORIES NOT INCLUDED

Accessories to be ordered separately.

POLES

Full technical details of poles and accessories for poles are available at the end of the catalogue

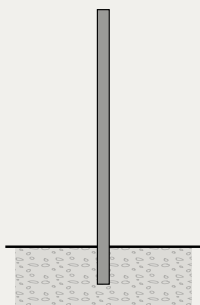

BURIED POLES

code	h. mm.
809901	3.500
809902	4.500
809903	5.500
809909	Top cap diam 76mm

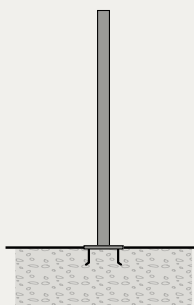

POLES WITH BASE-PLATE

code	h. mm.
809904	3.000
809905	4.000
809906	5.000
809907	Anchorage unit for base-plate
809909	Top cap diam 76mm





Flash Pole

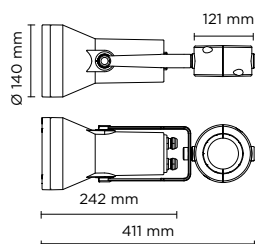

PRODUCT WEIGHT 3.00 kg



Code Example

805001.27.10.01.0

Accessories p. 387

Flash Pole Medium Single

Round pole-mounted floodlight for outdoor installation on a pole diam. 60 mm or 76 mm. Phospho-chromatised and polyester powder coated die-cast copper-free aluminium body, tempered safety glass, moulded silicone gasket and stainless steel screws. Clamp for pole diam 60 mm or 76 mm included. Built-in LED driver 220-240V 50-60Hz, with 5 CREE XP-G3 high-power LED. IP65 rating.

805001
8W

CCT	Beam Angle	lm	lm/w	Finish	Dimming
.27 2700°K	.10 10°	684	85.50	.01 RAL 9006	.0 ON/OFF
	.30 30°	650	81.25	.02 RAL 7016	.1 1-10 V
	.45 45°	617	77.12	.03 RAL 9005	.D DALI
.30 3000°K	.10 10°	720	90.00		
	.30 30°	684	85.50		
	.45 45°	650	81.25		
.40 4000°K	.10 10°	750	93.75		
	.30 30°	713	89.13		
	.45 45°	677	84.63		

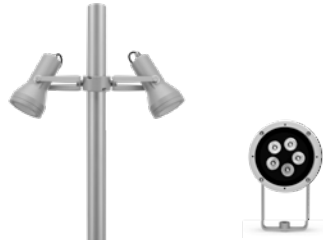
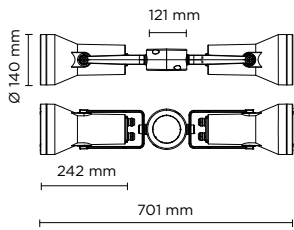

PRODUCT WEIGHT 5,60 kg



Code Example

805005 .27 .10 .01 .0

Accessories p. 387

Flash Pole Medium Double

Round pole-mounted floodlight for outdoor installation on a pole diam. 60 mm or 76 mm. Phospho-chromatised and polyester powder coated die-cast copper-free aluminium body, tempered safety glass, moulded silicone gasket and stainless steel screws. Clamp for pole diam 60 mm or 76 mm included. Built-in LED driver 220-240V 50-60Hz, with 5 CREE XP-G3 high-power LED. IP65 rating.

805005
2x8W

CCT	Beam Angle	lm	lm/w	Finish	Dimming
.27 2700°K	.10 10°	2x684	85.50	.01 RAL 9006	.0 ON/OFF
	.30 30°	2x650	81.25	.02 RAL 7016	.1 1-10 V
	.45 45°	2x617	77.12	.03 RAL 9005	.D DALI
.30 3000°K	.10 10°	2x720	90.00		
	.30 30°	2x684	85.50		
	.45 45°	2x650	81.25		
.40 4000°K	.10 10°	2x750	93.75		
	.30 30°	2x713	89.13		
	.45 45°	2x677	84.63		

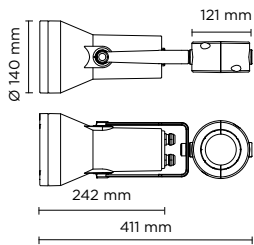

PRODUCT WEIGHT 3,00 kg



Code Example

805002 .27 .35 .01 .0

Accessories p. 387

Flash Pole Medium Cob Single

Round pole-mounted floodlight for outdoor installation on a pole diam. 60 mm or 76 mm. Phospho-chromatised and polyester powder coated die-cast copper-free aluminium body, tempered safety glass, moulded silicone gasket and stainless steel screws. Clamp for pole diam 60 mm or 76 mm included. Built-in LED driver 220-240V 50-60Hz, with 1 CREE CXA 1512 COB LED. IP65 rating.

805002
18W

CCT	Beam Angle	lm	lm/w	Finish	Dimming
.27 2700°K	.35 35°	1.453	80.72	.01 RAL 9006	.0 ON/OFF
				.02 RAL 7016	.1 1-10 V
.30 3000°K	.35 35°	1.530	85.00	.03 RAL 9005	.D DALI

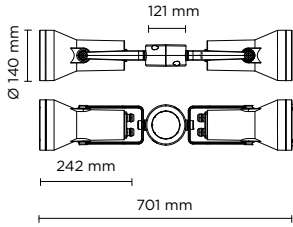

PRODUCT WEIGHT 5,60 kg



Code Example

805006.27.35.01.0

Accessories p. 387

Flash Pole Medium Cob Double

Round pole-mounted floodlight for outdoor installation on a pole diam. 60 mm or 76 mm. Phospho-chromatised and polyester powder coated die-cast copper-free aluminium body, tempered safety glass, moulded silicone gasket and stainless steel screws. Clamp for pole diam 60 mm or 76 mm included. Built-in LED driver 220-240V 50-60Hz, with 1 CREE CXA 1512 COB LED. IP65 rating.

805006
2x18W

CCT	Beam Angle	lm	lm/w	Finish	Dimming
.27 2700°K	.35 35°	2x1.453	2x80.72	.01 RAL 9006	.0 ON/OFF
.30 3000°K	.35 35°	2x1.530	85.00	.02 RAL 7016	.1 1-10 V
				.03 RAL 9005	.D DALI

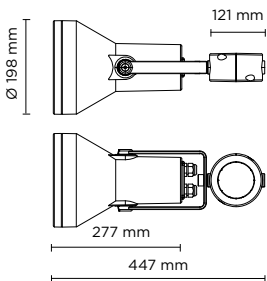

PRODUCT WEIGHT 4,00 kg



Code Example

805003.27.10.01.0

Accessories p. 387

Flash Pole Maxi Single

Round pole-mounted floodlight for outdoor installation on a pole diam. 60 mm or 76 mm. Phospho-chromatised and polyester powder coated die-cast copper-free aluminium body, tempered safety glass, moulded silicone gasket and stainless steel screws. Clamp for pole diam 60 mm or 76 mm included. Built-in LED driver 220-240V 50-60Hz, with 8 CREE XP-G3 high-power LED. IP65 rating.

805003
12W

CCT	Beam Angle	lm	lm/w	Finish	Dimming
.27 2700°K	.10 10°	1.094	91.17	.01 RAL 9006	.0 ON/OFF
	.30 30°	1.040	86.67		
	.45 45°	988	82.33		
.30 3000°K	.10 10°	1.152	96.00	.02 RAL 7016	.1 1-10 V
	.30 30°	1.095	91.25		
	.45 45°	1.040	86.67		
.40 4000°K	.10 10°	1.200	100.00	.03 RAL 9005	.D DALI
	.30 30°	1.140	95.00		
	.45 45°	1.083	90.25		

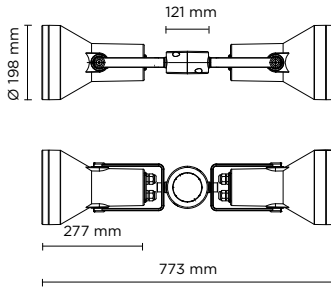

PRODUCT WEIGHT 7,50 kg



Code Example

805007.27.10.01.0

Accessories p. 387

Flash Pole Maxi Double

Round pole-mounted floodlight for outdoor installation on a pole diam. 60 mm or 76 mm. Phospho-chromatised and polyester powder coated die-cast copper-free aluminium body, tempered safety glass, moulded silicone gasket and stainless steel screws. Clamp for pole diam 60 mm or 76 mm included. Built-in LED driver 220-240V 50-60Hz, with 8 CREE XP-G3 high-power LED. IP65 rating.

805007

2x12W

CCT	Beam Angle	lm	lm/w	Finish	Dimming
.27 2700°K	.10 10°	2x1.094	91.17	.01 RAL 9006	.0 ON/OFF
	.30 30°	2x1.040	86.67	.02 RAL 7016	.1 1-10 V
	.45 45°	2x988	82.33	.03 RAL 9005	.D DALI
.30 3000°K	.10 10°	2x1.152	96.00		
	.30 30°	2x1.095	91.25		
	.45 45°	2x1.040	86.67		
.40 4000°K	.10 10°	2x1.200	100.00		
	.30 30°	2x1.140	95.00		
	.45 45°	2x1.083	90.25		

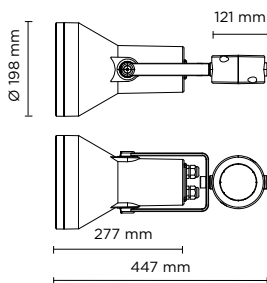

PRODUCT WEIGHT 4,00 kg



Code Example

805004.27.35.01.0

Accessories p. 387

Flash Pole Maxi Cob Single

Round pole-mounted floodlight for outdoor installation on a pole diam. 60 mm or 76 mm. Phospho-chromatised and polyester powder coated die-cast copper-free aluminium body, tempered safety glass, moulded silicone gasket and stainless steel screws. Clamp for pole diam 60 mm or 76 mm included. Built-in LED driver 220-240V 50-60Hz, with 1 CREE CXB 2530 COB LED. IP65 rating.

805004

36W

CCT	Beam Angle	lm	lm/w	Finish	Dimming
.27 2700°K	.35 35°	2.945	81.80	.01 RAL 9006	.0 ON/OFF
	.35 35°	3.100	86.10	.02 RAL 7016	.1 1-10 V
.30 3000°K	.35 35°	3.100	86.10	.03 RAL 9005	.D DALI

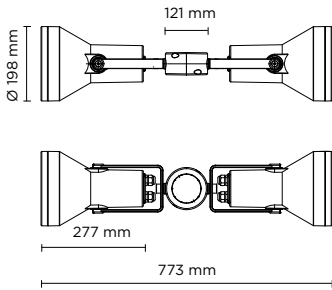

PRODUCT WEIGHT 7,50 kg



Code Example

805008.27.35.01.0

Accessories p. 387

Flash Pole Maxi Cob Double

Round pole-mounted floodlight for outdoor installation on a pole diam. 60 mm or 76 mm. Phospho-chromatised and polyester powder coated die-cast copper-free aluminium body, tempered safety glass, moulded silicone gasket and stainless steel screws. Clamp for pole diam 60 mm or 76 mm included. Built-in LED driver 220-240V 50-60Hz, with 1 CREE CXB 2530 COB LED. IP65 rating.

805008
2x36W

CCT	Beam Angle	lm	lm/w	Finish	Dimming
.27 2700°K	.35 35°	2x2.945	81.80	.01 RAL 9006	.0 ON/OFF
.30 3000°K	.35 35°	2x3.100	86.10	.02 RAL 7016	.1 1-10 V
				.03 RAL 9005	.D DALI

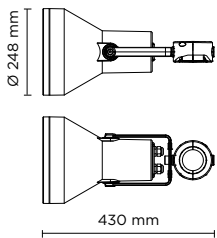

PRODUCT WEIGHT 5,50 kg



Code Example

805009.27.10.01.0

Accessories p. 387

Flash Pole Mega Single

Round pole-mounted floodlight for outdoor installation on a pole diam. 60 mm or 76 mm. Phospho-chromatised and polyester powder coated die-cast copper-free aluminium body, tempered safety glass, moulded silicone gasket and stainless steel screws. Clamp for pole diam 60 mm or 76 mm included. Built-in LED driver 220-240V 50-60Hz, with 15 CREE XP-G2 high-power LED. IP65 rating.

805009
22W

CCT	Beam Angle	lm	lm/w	Finish	Dimming
.27 2700°K	.10 10°	2.052	93.27	.01 RAL 9006	.0 ON/OFF
	.30 30°	1.949	88.59		
	.45 45°	1.852	84.18		
.30 3000°K	.10 10°	2.160	98.18	.02 RAL 7016	.1 1-10 V
	.30 30°	2.052	93.27		
	.45 45°	1.949	88.60		
.40 4000°K	.10 10°	2.250	102.28	.03 RAL 9005	.D DALI
	.30 30°	2.137	97.14		
	.45 45°	2.030	92.27		

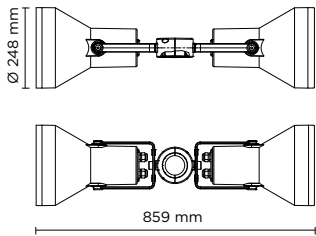

PRODUCT WEIGHT 10,50 kg



Code Example

805011 .27 .10 .01 .0

Accessories p. 387

Flash Pole Mega Double

Round pole-mounted floodlight for outdoor installation on a pole diam. 60 mm or 76 mm. Phospho-chromatised and polyester powder coated die-cast copper-free aluminium body, tempered safety glass, moulded silicone gasket and stainless steel screws. Clamp for pole diam 60 mm or 76 mm included. Built-in LED driver 220-240V 50-60Hz, with 15 CREE XP-G2 high-power LED. IP65 rating.

805011

2x22W

CCT	Beam Angle	lm	lm/w	Finish	Dimming
.27 2700°K	.10 10°	2x2.052	93.27	.01 RAL 9006	.0 ON/OFF
	.30 30°	2x1.949	88.59	.02 RAL 7016	.1 1-10 V
	.45 45°	2x1.852	84.18	.03 RAL 9005	.D DALI
.30 3000°K	.10 10°	2x2.160	98.18		
	.30 30°	2x2.052	93.27		
	.45 45°	2x1.949	88.60		
.40 4000°K	.10 10°	2x2.250	102.28		
	.30 30°	2x2.137	97.14		
	.45 45°	2x2.030	92.27		

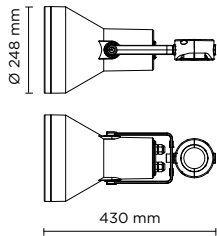

PRODUCT WEIGHT 5,50 kg



Code Example

805010 .27 .35 .01 .0

Accessories p. 387

Flash Pole Mega Cob Single

Round pole-mounted floodlight for outdoor installation on a pole diam. 60 mm or 76 mm. Phospho-chromatised and polyester powder coated die-cast copper-free aluminium body, tempered safety glass, moulded silicone gasket and stainless steel screws. Clamp for pole diam 60 mm or 76 mm included. Built-in LED driver 220-240V 50-60Hz, with 1 CREE CXB 3070 COB LED. IP65 rating.

805010

55W

CCT	Beam Angle	lm	lm/w	Finish	Dimming
.27 2700°K	.35 35°	4.493	81.69	.01 RAL 9006	.0 ON/OFF
				.02 RAL 7016	.1 1-10 V
.30 3000°K	.35 35°	4.730	86.00	.03 RAL 9005	.D DALI

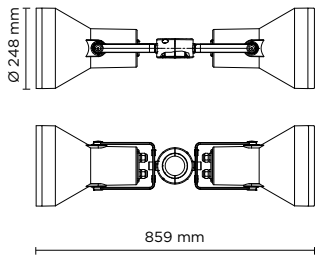

PRODUCT WEIGHT 10,50 kg



Code Example

805012 .27 .35 .01 .0

Accessories p. 387

Flash Pole Mega Cob Double

Round pole-mounted floodlight for outdoor installation on a pole diam. 60 mm or 76 mm. Phospho-chromatised and polyester powder coated die-cast copper-free aluminium body, tempered safety glass, moulded silicone gasket and stainless steel screws. Clamp for pole diam 60 mm or 76 mm included. Built-in LED driver 220-240V 50-60Hz, with 1 CREE CXB 3070 COB LED. IP65 rating.

CCT	Beam Angle	lm	lm/w	Finish	Dimming
805012 2x55W	.27 2700°K	.35 35°	2x4.493 81.69	.01 RAL 9006	.0 ON/OFF
	.30 3000°K	.35 35°	2x4.730 86.00	.02 RAL 7016	.1 1-10 V
				.03 RAL 9005	.D DALI



ACCESSORIES NOT INCLUDED

Accessories to be ordered separately.

POLES

Full technical details of poles and accessories for poles are available at the end of the catalogue

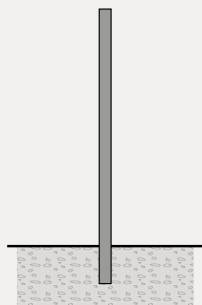

BURIED POLES

code	h. mm.
809901	3.500
809902	4.500
809903	5.500
809909	Top cap diam 76mm

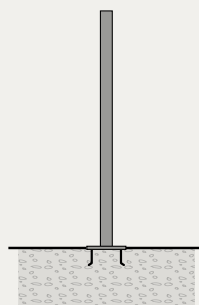

POLES WITH BASE-PLATE

code	h. mm.
809904	3.000
809905	4.000
809906	5.000
809907	Anchorage unit for base-plate
809909	Top cap diam 76mm



ANTI-GLARE VISOR

AC027

FOR ALL MEDIUM AND MAXI ITEMS

GRADUATED STAINLESS STEEL INSERT

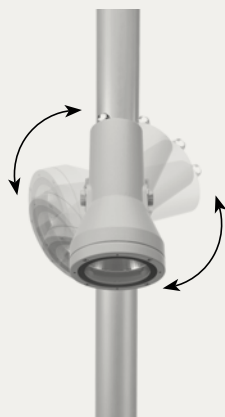

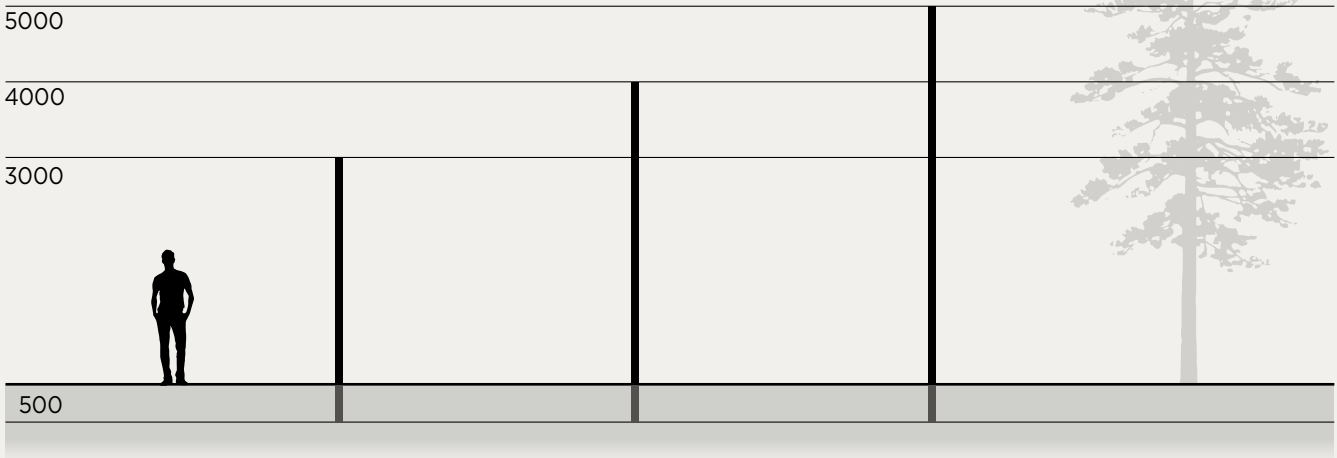

809901 CYLINDRICAL POLE 3,5 M.
TO BE BURIED

Cylindrical pole made in steel S235JR (UNI EN 10219) hot galvanized (UNI EN 1461), **diameter 76 mm, thickness 4 mm.** Phospho-chromatised and polyester powder coated.
Total height 3.500 mm, including 500 mm to be buried into the ground. Includes IP54 cover plate 132x38 mm and terminal block in double insulation.

809902 CYLINDRICAL POLE 4,5 M.
TO BE BURIED

Cylindrical pole made in steel S235JR (UNI EN 10219) hot galvanized (UNI EN 1461), **diameter 76 mm, thickness 4 mm.** Phospho-chromatised and polyester powder coated.
Total height 4.500 mm, including 500 mm to be buried into the ground. Includes IP54 cover plate 132x38 mm and terminal block in double insulation.

809903 CYLINDRICAL POLE 5,5 M.
TO BE BURIED

Cylindrical pole made in steel S235JR (UNI EN 10219) hot galvanized (UNI EN 1461), **diameter 76 mm, thickness 4 mm.** Phospho-chromatised and polyester powder coated.
Total height 5.500 mm, including 500 mm to be buried into the ground. Includes IP54 cover plate 132x38 mm and terminal block in double insulation.

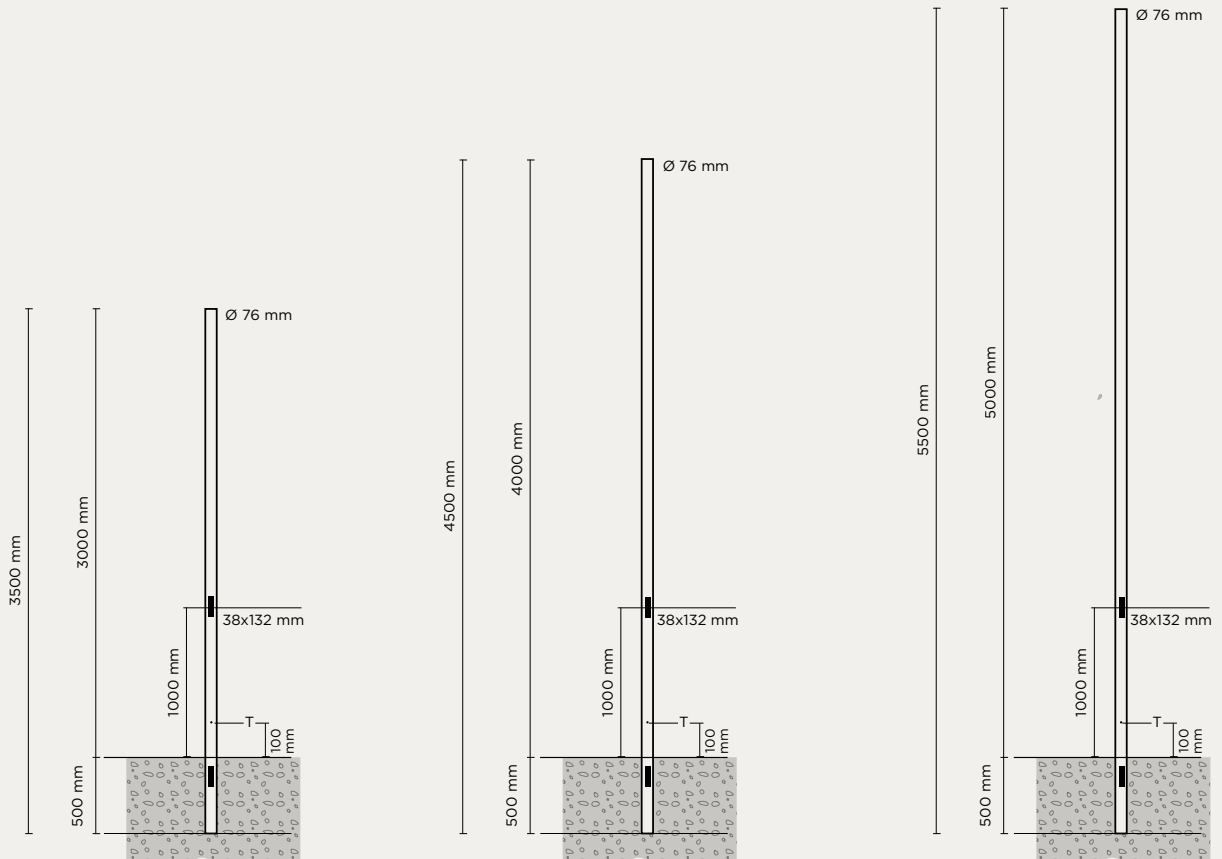

T= Grounding, threaded galvanized insert pole Thickness= 4mm

T= Grounding, threaded galvanized insert pole Thickness= 4mm

T= Grounding, threaded galvanized insert pole Thickness= 4mm

POLES - POLES WITH BASE-PLATE

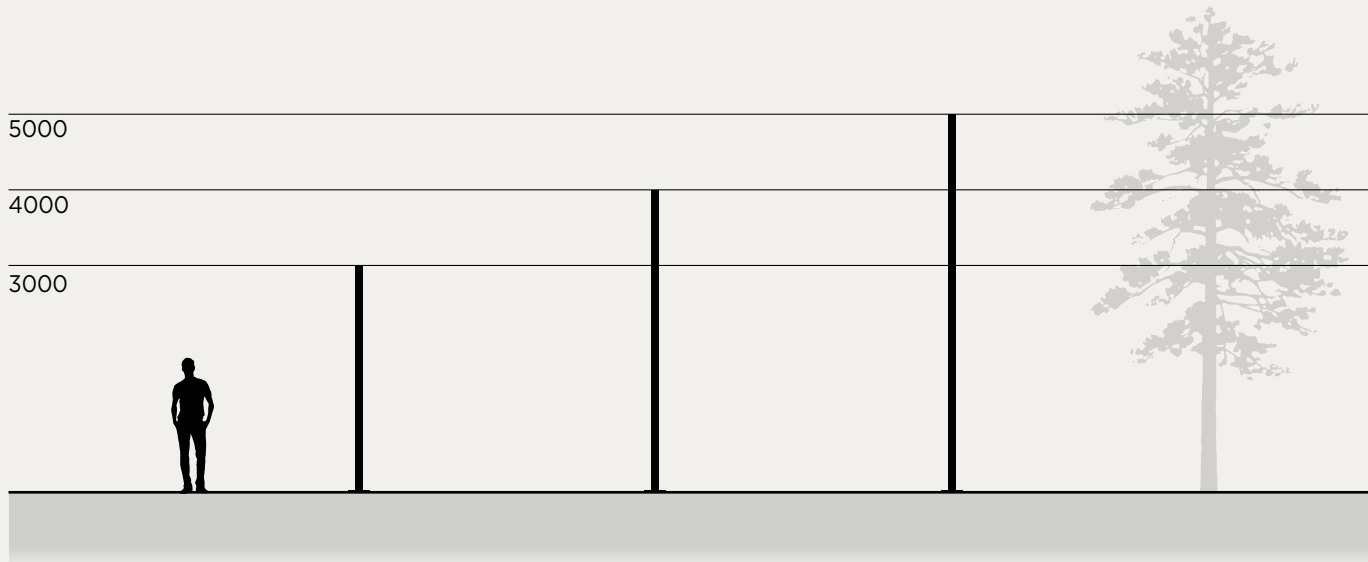

809904 CYLINDRICAL POLE 3 M.
WITH BASE-PLATE

Cylindrical pole made in steel S235JR (UNI EN 10219) hot galvanized (UNI EN 1461), **diameter 76 mm, thickness 4 mm.** Phospho-chromatised and polyester powder coated. **Total height 3.000 mm, with base plate dim. 250x250 mm,** thickness 10 mm. Includes IP54 cover plate 132x38 mm and terminal block in double insulation.

809905 CYLINDRICAL POLE 4 M.
WITH BASE-PLATE

Cylindrical pole made in steel S235JR (UNI EN 10219) hot galvanized (UNI EN 1461), **diameter 76 mm, thickness 4 mm.** Phospho-chromatised and polyester powder coated. **Total height 4.000 mm, with base plate dim. 250x250 mm,** thickness 10 mm. Includes IP54 cover plate 132x38 mm and terminal block in double insulation.

809906 CYLINDRICAL POLE 5 M.
WITH BASE-PLATE

Cylindrical pole made in steel S235JR (UNI EN 10219) hot galvanized (UNI EN 1461), **diameter 76 mm, thickness 4 mm.** Phospho-chromatised and polyester powder coated. **Total height 5.000 mm, with base plate dim. 250x250 mm,** thickness 10 mm. Includes IP54 cover plate 132x38 mm and terminal block in double insulation.

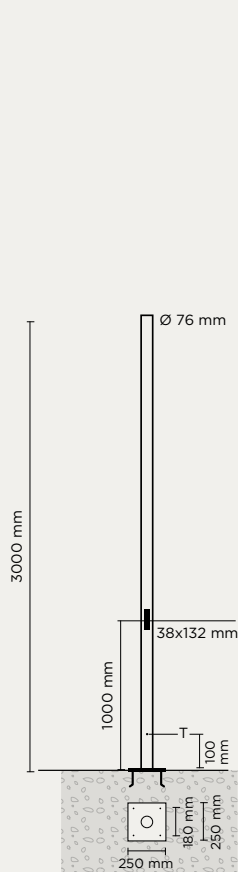

T= Grounding, threaded galvanized insert pole Thickness= 4mm

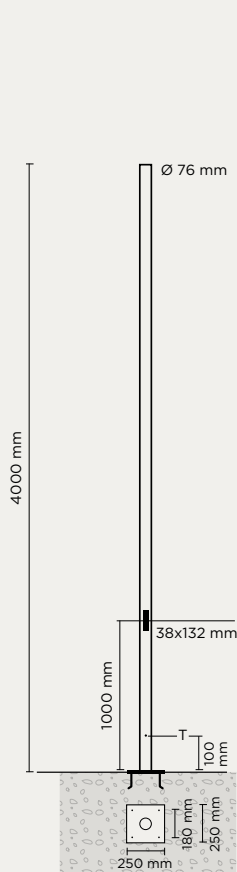

T= Grounding, threaded galvanized insert pole Thickness= 4mm

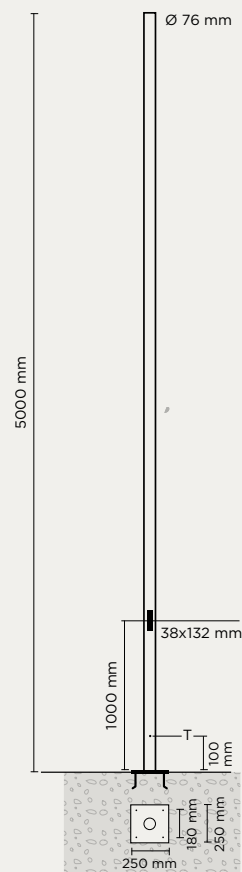

T= Grounding, threaded galvanized insert pole Thickness= 4mm



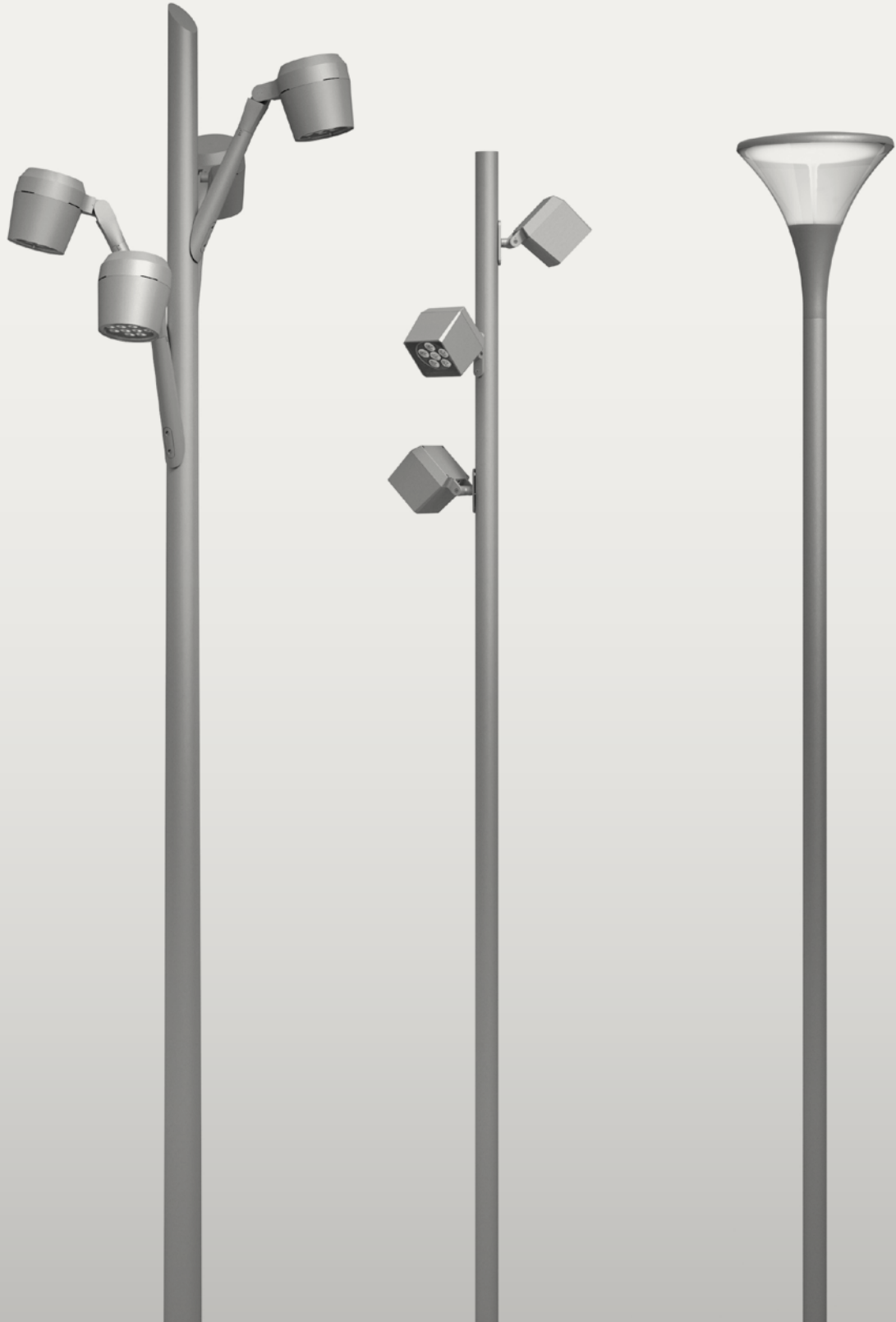

DÉCOR





Vetra Sphera

Nava + Arosio

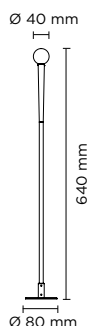

PRODUCT WEIGHT 0,70 kg



Code Example

902001 .27 .DF .07 .0

Accessories p. 399

Vetra Sphera Small 600

Outdoor lighting solution designed to guide and enhance exterior spaces with refined illumination. Featuring a minimalist stainless-steel bollard structure and a distinctive glass element that softens and diffuses the emitted light. All structural parts are phospho-chromatised and polyester powder coated. Total height 640 mm. Remote constant voltage 24V DC power supply needed. IP66 rating.



902001
3W
Transparent Glass

CCT	Beam Angle	lm	lm/w
.27 2700°K	.DF diffused	110	36.60
.30 3000°K	.DF diffused	120	40.00
.40 4000°K	.DF diffused	140	46.60

Finish	Dimming
.07 Obsidian Black	.0 ON/OFF
.08 Wild Green	
.09 Dark Brown	



902002
3W
Opal Glass

CCT	Beam Angle	lm	lm/w
.27 2700°K	.DF diffused	110	36.60
.30 3000°K	.DF diffused	120	40.00
.40 4000°K	.DF diffused	140	46.60

Finish	Dimming
.07 Obsidian Black	.0 ON/OFF
.08 Wild Green	
.09 Dark Brown	

Remote Driver Selection

Brand	Manufacturer code	Type	Watt	IP Rate	Number of fixtures
Meanwell	LPV-20-24	Contant voltage 24V DC	20W	IP67	min 1 - max 4
Meanwell	LPV-35-24	Contant voltage 24V DC	35W	IP67	min 1 - max 8

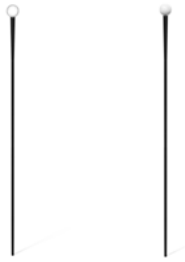
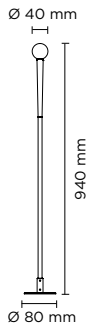

PRODUCT WEIGHT 0,90 kg



Vetra Sphera Small 900

Outdoor lighting solution designed to guide and enhance exterior spaces with refined illumination. Featuring a minimalist stainless-steel bollard structure and a distinctive glass element that softens and diffuses the emitted light. All structural parts are phospho-chromatised and polyester powder coated. Total height 940 mm. Remote constant voltage 24V DC power supply needed. IP66 rating.

Code Example

902003 .27 .DF .07 .0

Accessories p. 399



902003
3W
Transparent Glass

CCT	Beam Angle	lm	lm/w
.27 2700°K	.DF diffused	110	36.60
.30 3000°K	.DF diffused	120	40.00
.40 4000°K	.DF diffused	140	46.60

Finish	Dimming
.07 Obsidian Black	.0 ON/OFF
.08 Wild Green	
.09 Dark Brown	



902004
3W
Opal Glass

CCT	Beam Angle	lm	lm/w
.27 2700°K	.DF diffused	110	36.60
.30 3000°K	.DF diffused	120	40.00
.40 4000°K	.DF diffused	140	46.60

Finish	Dimming
.07 Obsidian Black	.0 ON/OFF
.08 Wild Green	
.09 Dark Brown	

Remote Driver Selection

Brand	Manufacturer code	Type	Watt	IP Rate	Number of fixtures
Meanwell	LPV-20-24	Contant voltage 24V DC	20W	IP67	min 1 - max 4
Meanwell	LPV-35-24	Contant voltage 24V DC	35W	IP67	min 1 - max 8



Obsidian Black



Wild Green



Dark Brown

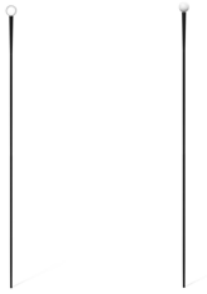

PRODUCT WEIGHT 1,10 kg



Vetra Sphera Small 1200

Code Example

902005 .27 .DF .07 .0

Accessories p. 399

Outdoor lighting solution designed to guide and enhance exterior spaces with refined illumination. Featuring a minimalist stainless-steel bollard structure and a distinctive glass element that softens and diffuses the emitted light. All structural parts are phospho-chromatised and polyester powder coated. Total height 1240 mm. Remote constant voltage 24V DC power supply needed. IP66 rating.



902005
3W
Transparent Glass

CCT	Beam Angle	Im	Im/w
.27 2700°K	.DF diffused	110	36.60
.30 3000°K	.DF diffused	120	40.00
.40 4000°K	.DF diffused	140	46.60

Finish	Dimming
.07 Obsidian Black	.0 ON/OFF
.08 Wild Green	
.09 Dark Brown	



902006
3W
Opal Glass

CCT	Beam Angle	Im	Im/w
.27 2700°K	.DF diffused	110	36.60
.30 3000°K	.DF diffused	120	40.00
.40 4000°K	.DF diffused	140	46.60

Finish	Dimming
.07 Obsidian Black	.0 ON/OFF
.08 Wild Green	
.09 Dark Brown	

Remote Driver Selection

Brand	Manufacturer code	Type	Watt	IP Rate	Number of fixtures
Meanwell	LPV-20-24	Contant voltage 24V DC	20W	IP67	min 1 - max 4
Meanwell	LPV-35-24	Contant voltage 24V DC	35W	IP67	min 1 - max 8



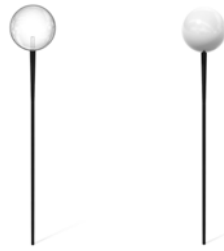
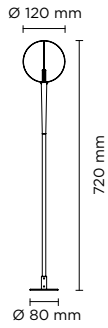

PRODUCT WEIGHT 0,80 kg



Vetra Sphera Big 600

Code Example

902007 .27 .DF .07 .0

Accessories p. 399

Outdoor lighting solution designed to guide and enhance exterior spaces with refined illumination. Featuring a minimalist stainless-steel bollard structure and a distinctive glass element that softens and diffuses the emitted light. All structural parts are phospho-chromatised and polyester powder coated. Total height 720 mm. Remote constant voltage 24V DC power supply needed. IP66 rating.



902007
3W
Transparent Glass

CCT	Beam Angle	lm	lm/w
.27 2700°K	.DF diffused	110	36.60
.30 3000°K	.DF diffused	120	40.00
.40 4000°K	.DF diffused	140	46.60

Finish	Dimming
.07 Obsidian Black	.0 ON/OFF
.08 Wild Green	
.09 Dark Brown	



902008
3W
Opal Glass

CCT	Beam Angle	lm	lm/w
.27 2700°K	.DF diffused	110	36.60
.30 3000°K	.DF diffused	120	40.00
.40 4000°K	.DF diffused	140	46.60

Finish	Dimming
.07 Obsidian Black	.0 ON/OFF
.08 Wild Green	
.09 Dark Brown	

Remote Driver Selection

Brand	Manufacturer code	Type	Watt	IP Rate	Number of fixtures
Meanwell	LPV-20-24	Contant voltage 24V DC	20W	IP67	min 1 - max 4
Meanwell	LPV-35-24	Contant voltage 24V DC	35W	IP67	min 1 - max 8



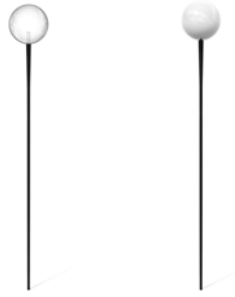
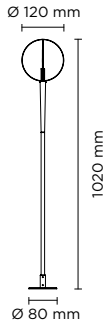

PRODUCT WEIGHT 1,00 kg



Code Example

902009 .27 .DF .07 .0

Accessories p. 399

Vetra Sphera Big 900

Outdoor lighting solution designed to guide and enhance exterior spaces with refined illumination. Featuring a minimalist stainless-steel bollard structure and a distinctive glass element that softens and diffuses the emitted light. All structural parts are phospho-chromatised and polyester powder coated. Total height 1020 mm. Remote constant voltage 24V DC power supply needed. IP66 rating.



902009
3W
Transparent Glass

CCT	Beam Angle	Im	Im/w
.27 2700°K	.DF diffused	110	36.60
.30 3000°K	.DF diffused	120	40.00
.40 4000°K	.DF diffused	140	46.60

Finish	Dimming
.07 Obsidian Black	.0 ON/OFF
.08 Wild Green	
.09 Dark Brown	



902010
3W
Opal Glass

CCT	Beam Angle	Im	Im/w
.27 2700°K	.DF diffused	110	36.60
.30 3000°K	.DF diffused	120	40.00
.40 4000°K	.DF diffused	140	46.60

Finish	Dimming
.07 Obsidian Black	.0 ON/OFF
.08 Wild Green	
.09 Dark Brown	

Remote Driver Selection

Brand	Manufacturer code	Type	Watt	IP Rate	Number of fixtures
Meanwell	LPV-20-24	Contant voltage 24V DC	20W	IP67	min 1 - max 4
Meanwell	LPV-35-24	Contant voltage 24V DC	35W	IP67	min 1 - max 8



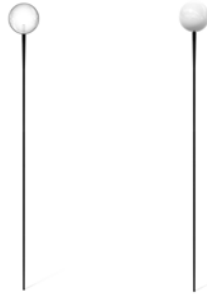
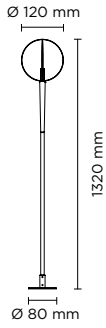

PRODUCT WEIGHT 1,20 kg



Vetra Sphera Big 1200

Code Example

902011 .27 .DF .07 .0

Accessories p. 399

Outdoor lighting solution designed to guide and enhance exterior spaces with refined illumination. Featuring a minimalist stainless-steel bollard structure and a distinctive glass element that softens and diffuses the emitted light. All structural parts are phospho-chromatised and polyester powder coated. Total height 1320 mm. Remote constant voltage 24V DC power supply needed. IP66 rating.



902011
3W
Transparent Glass

CCT	Beam Angle	Im	Im/w
.27 2700°K	.DF diffused	110	36.60
.30 3000°K	.DF diffused	120	40.00
.40 4000°K	.DF diffused	140	46.60

Finish	Dimming
.07 Obsidian Black	.0 ON/OFF
.08 Wild Green	
.09 Dark Brown	



902012
3W
Opal Glass

CCT	Beam Angle	Im	Im/w
.27 2700°K	.DF diffused	110	36.60
.30 3000°K	.DF diffused	120	40.00
.40 4000°K	.DF diffused	140	46.60

Finish	Dimming
.07 Obsidian Black	.0 ON/OFF
.08 Wild Green	
.09 Dark Brown	

Remote Driver Selection

Brand	Manufacturer code	Type	Watt	IP Rate	Number of fixtures
Meanwell	LPV-20-24	Contant voltage 24V DC	20W	IP67	min 1 - max 4
Meanwell	LPV-35-24	Contant voltage 24V DC	35W	IP67	min 1 - max 8

ACCESSORIES NOT INCLUDED

Accessories to be ordered separately.



AC146

SPIKE

Stainless steel ground spike.

Compatible for all products of the series.



Vetra Filis

Nava + Arosio

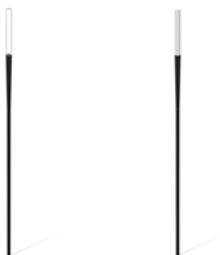
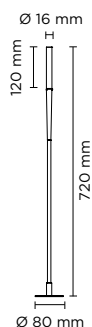

PRODUCT WEIGHT 0,80 kg



Code Example

903001, .27, .DF, .07, 0

Accessories p. 402

Vetra Filis 600

Outdoor lighting solution designed to guide and enhance exterior spaces with refined illumination. Featuring a minimalist stainless-steel bollard structure and a distinctive glass element that softens and diffuses the emitted light. All structural parts are phospho-chromatised and polyester powder coated. Total height 720 mm. Remote constant voltage 24V DC power supply needed. IP66 rating.



903001
3W
Transparent Glass

CCT	Beam Angle	lm	lm/w
.27 2700°K	.DF diffused	110	36.60
.30 3000°K	.DF diffused	120	40.00
.40 4000°K	.DF diffused	140	46.60

Finish	Dimming
.07 Obsidian Black	.0 ON/OFF
.08 Wild Green	
.09 Dark Brown	



903002
3W
Opal Glass

CCT	Beam Angle	lm	lm/w
.27 2700°K	.DF diffused	110	36.60
.30 3000°K	.DF diffused	120	40.00
.40 4000°K	.DF diffused	140	46.60

Finish	Dimming
.07 Obsidian Black	.0 ON/OFF
.08 Wild Green	
.09 Dark Brown	

Remote Driver Selection

Brand	Manufacturer code	Type	Watt	IP Rate	Number of fixtures
Meanwell	LPV-20-24	Contant voltage 24V DC	20W	IP67	min 1 - max 4
Meanwell	LPV-35-24	Contant voltage 24V DC	35W	IP67	min 1 - max 8

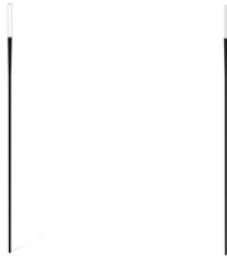
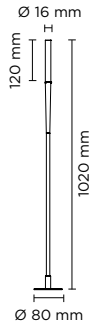

PRODUCT WEIGHT 1,00 kg



Vetra Filis 900

Outdoor lighting solution designed to guide and enhance exterior spaces with refined illumination. Featuring a minimalist stainless-steel bollard structure and a distinctive glass element that softens and diffuses the emitted light. All structural parts are phospho-chromatised and polyester powder coated. Total height 1020 mm. Remote constant voltage 24V DC power supply needed. IP66 rating.

Code Example

903003, .27, .DF, .07, 0

Accessories p. 402



903003
3W
Transparent Glass

CCT	Beam Angle	Im	Im/w
.27 2700°K	.DF diffused	110	36.60
.30 3000°K	.DF diffused	120	40.00
.40 4000°K	.DF diffused	140	46.60

Finish	Dimming
.07 Obsidian Black	.0 ON/OFF
.08 Wild Green	
.09 Dark Brown	



903004
3W
Opal Glass

CCT	Beam Angle	Im	Im/w
.27 2700°K	.DF diffused	110	36.60
.30 3000°K	.DF diffused	120	40.00
.40 4000°K	.DF diffused	140	46.60

Finish	Dimming
.07 Obsidian Black	.0 ON/OFF
.08 Wild Green	
.09 Dark Brown	

Remote Driver Selection

Brand	Manufacturer code	Type	Watt	IP Rate	Number of fixtures
Meanwell	LPV-20-24	Contant voltage 24V DC	20W	IP67	min 1 - max 4
Meanwell	LPV-35-24	Contant voltage 24V DC	35W	IP67	min 1 - max 8

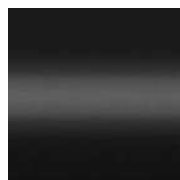

Obsidian Black



Wild Green



Dark Brown

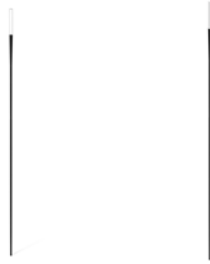
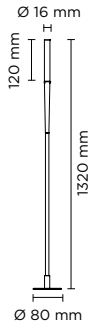

PRODUCT WEIGHT 1,20 kg



Vetra Filis 1200

Code Example

903005 .27 .DF .07 .0

Accessories p. 402

Outdoor lighting solution designed to guide and enhance exterior spaces with refined illumination. Featuring a minimalist stainless-steel bollard structure and a distinctive glass element that softens and diffuses the emitted light. All structural parts are phospho-chromatised and polyester powder coated. Total height 1320 mm. Remote constant voltage 24V DC power supply needed. IP66 rating.



903005
3W
Transparent Glass

CCT	Beam Angle	lm	lm/w
.27 2700°K	.DF diffused	110	36.60
.30 3000°K	.DF diffused	120	40.00
.40 4000°K	.DF diffused	140	46.60

Finish	Dimming
.07 Obsidian Black	.0 ON/OFF
.08 Wild Green	
.09 Dark Brown	



903006
3W
Opal Glass

CCT	Beam Angle	lm	lm/w
.27 2700°K	.DF diffused	110	36.60
.30 3000°K	.DF diffused	120	40.00
.40 4000°K	.DF diffused	140	46.60

Finish	Dimming
.07 Obsidian Black	.0 ON/OFF
.08 Wild Green	
.09 Dark Brown	

Remote Driver Selection

Brand	Manufacturer code	Type	Watt	IP Rate	Number of fixtures
Meanwell	LPV-20-24	Contant voltage 24V DC	20W	IP67	min 1 - max 4
Meanwell	LPV-35-24	Contant voltage 24V DC	35W	IP67	min 1 - max 8

ACCESSORIES NOT INCLUDED

Accessories to be ordered separately.



AC146

SPIKE

Stainless steel ground spike.

Compatible for all products of the series.





Vetra Dot

Nava + Arosio



PRODUCT WEIGHT 0,70 kg



Vetra Dot 600

Code Example

904001, .27, .DF, .07, 0

Accessories p. 407

Outdoor lighting solution designed to guide and enhance exterior spaces with refined illumination. Featuring a minimalist stainless-steel bollard structure and a distinctive glass element that softens and diffuses the emitted light. All structural parts are phospho-chromatised and polyester powder coated. Total height 620 mm. Remote constant voltage 24V DC power supply needed. IP66 rating.



904001
3W
Transparent Glass

CCT	Beam Angle	lm	lm/w
.27 2700°K	.DF diffused	110	36.60
.30 3000°K	.DF diffused	120	40.00
.40 4000°K	.DF diffused	140	46.60

Finish	Dimming
.07 Obsidian Black	.0 ON/OFF
.08 Wild Green	
.09 Dark Brown	



904002
3W
Opal Glass

CCT	Beam Angle	lm	lm/w
.27 2700°K	.DF diffused	110	36.60
.30 3000°K	.DF diffused	120	40.00
.40 4000°K	.DF diffused	140	46.60

Finish	Dimming
.07 Obsidian Black	.0 ON/OFF
.08 Wild Green	
.09 Dark Brown	

Remote Driver Selection

Brand	Manufacturer code	Type	Watt	IP Rate	Number of fixtures
Meanwell	LPV-20-24	Contant voltage 24V DC	20W	IP67	min 1 - max 4
Meanwell	LPV-35-24	Contant voltage 24V DC	35W	IP67	min 1 - max 8

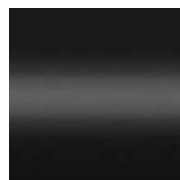

Obsidian Black



Wild Green



Dark Brown

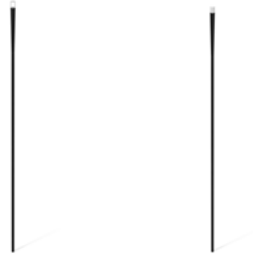

PRODUCT WEIGHT 0,90 kg



Vetra Dot 900

Code Example

904003.27.DF.07.0

Accessories p. 407

Outdoor lighting solution designed to guide and enhance exterior spaces with refined illumination. Featuring a minimalist stainless-steel bollard structure and a distinctive glass element that softens and diffuses the emitted light. All structural parts are phospho-chromatised and polyester powder coated. Total height 920 mm. Remote constant voltage 24V DC power supply needed. IP66 rating.



904003
3W
Transparent Glass

CCT	Beam Angle	lm	lm/w
.27 2700°K	.DF diffused	110	36.60
.30 3000°K	.DF diffused	120	40.00
.40 4000°K	.DF diffused	140	46.60

Finish	Dimming
.07 Obsidian Black	.0 ON/OFF
.08 Wild Green	
.09 Dark Brown	



904004
3W
Opal Glass

CCT	Beam Angle	lm	lm/w
.27 2700°K	.DF diffused	110	36.60
.30 3000°K	.DF diffused	120	40.00
.40 4000°K	.DF diffused	140	46.60

Finish	Dimming
.07 Obsidian Black	.0 ON/OFF
.08 Wild Green	
.09 Dark Brown	

Remote Driver Selection

Brand	Manufacturer code	Type	Watt	IP Rate	Number of fixtures
Meanwell	LPV-20-24	Contant voltage 24V DC	20W	IP67	min 1 - max 4
Meanwell	LPV-35-24	Contant voltage 24V DC	35W	IP67	min 1 - max 8

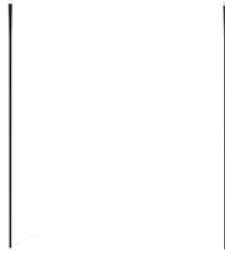

PRODUCT WEIGHT 1,10 kg



Code Example

904005, .27, .DF, .07, .0

Accessories p. 407

Vetra Dot 1200

Outdoor lighting solution designed to guide and enhance exterior spaces with refined illumination. Featuring a minimalist stainless-steel bollard structure and a distinctive glass element that softens and diffuses the emitted light. All structural parts are phospho-chromatised and polyester powder coated. Total height 1220 mm. Remote constant voltage 24V DC power supply needed. IP66 rating.



904005
3W
Transparent Glass

CCT	Beam Angle	lm	lm/w
.27 2700°K	.DF diffused	110	36.60
.30 3000°K	.DF diffused	120	40.00
.40 4000°K	.DF diffused	140	46.60

Finish	Dimming
.07 Obsidian Black	.0 ON/OFF
.08 Wild Green	
.09 Dark Brown	



904006
3W
Opal Glass

CCT	Beam Angle	lm	lm/w
.27 2700°K	.DF diffused	110	36.60
.30 3000°K	.DF diffused	120	40.00
.40 4000°K	.DF diffused	140	46.60

Finish	Dimming
.07 Obsidian Black	.0 ON/OFF
.08 Wild Green	
.09 Dark Brown	

Remote Driver Selection

Brand	Manufacturer code	Type	Watt	IP Rate	Number of fixtures
Meanwell	LPV-20-24	Contant voltage 24V DC	20W	IP67	min 1 - max 4
Meanwell	LPV-35-24	Contant voltage 24V DC	35W	IP67	min 1 - max 8

ACCESSORIES NOT INCLUDED

Accessories to be ordered separately.



AC146

SPIKE

Stainless steel ground spike.

Compatible for all products of the series.



Flexa Sphera

Nava + Arosio

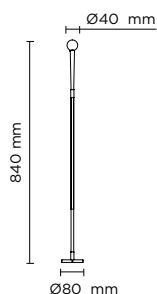

PRODUCT WEIGHT 080 kg



Code Example

905001, .27, .DF, .07, .0

Accessories p. 411

Flexa Sphera Small 800

Outdoor lighting solution designed to guide and enhance exterior spaces with refined illumination. Featuring a minimalist flexible stainless-steel bollard structure and a distinctive glass element that softens and diffuses the emitted light. All structural parts are phospho-chromatised and polyester powder coated. Total height 840 mm. Remote constant voltage 24V DC power supply needed. IP66 rating.



905001
3W
Transparent Glass

CCT	Beam Angle	lm	lm/w	Finish	Dimming
.27 2700°K	.DF diffused	110	36.60	.07 Obsidian Black	.0 ON/OFF
.30 3000°K	.DF diffused	120	40.00		
.40 4000°K	.DF diffused	140	46.60		



905002
3W
Opal Glass

CCT	Beam Angle	lm	lm/w	Finish	Dimming
.27 2700°K	.DF diffused	110	36.60	.07 Obsidian Black	.0 ON/OFF
.30 3000°K	.DF diffused	120	40.00		
.40 4000°K	.DF diffused	140	46.60		

Remote Driver Selection

Brand	Manufacturer code	Type	Watt	IP Rate	Number of fixtures
Meanwell	LPV-20-24	Contant voltage 24V DC	20W	IP67	min 1 - max 4
Meanwell	LPV-35-24	Contant voltage 24V DC	35W	IP67	min 1 - max 8

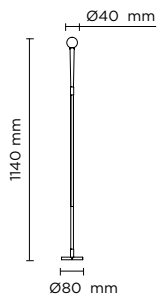

PRODUCT WEIGHT 1,00 kg



Code Example

905003.**.27**.**.DF**.**.07**.**.0**

Accessories p. 411

Flexa Sphera Small 1100

Outdoor lighting solution designed to guide and enhance exterior spaces with refined illumination. Featuring a minimalist flexible stainless-steel bollard structure and a distinctive glass element that softens and diffuses the emitted light. All structural parts are phospho-chromatised and polyester powder coated. Total height 1140 mm. Remote constant voltage 24V DC power supply needed. IP66 rating.



905003

3W
Transparent Glass

CCT	Beam Angle	lm	lm/w	Finish	Dimming
.27 2700°K	.DF diffused	110	36.60	.07 Obsidian Black	.0 ON/OFF
.30 3000°K	.DF diffused	120	40.00		
.40 4000°K	.DF diffused	140	46.60		



905004

3W
Opal Glass

CCT	Beam Angle	lm	lm/w	Finish	Dimming
.27 2700°K	.DF diffused	110	36.60	.07 Obsidian Black	.0 ON/OFF
.30 3000°K	.DF diffused	120	40.00		
.40 4000°K	.DF diffused	140	46.60		

Remote Driver Selection

Brand	Manufacturer code	Type	Watt	IP Rate	Number of fixtures
Meanwell	LPV-20-24	Contant voltage 24V DC	20W	IP67	min 1 - max 4
Meanwell	LPV-35-24	Contant voltage 24V DC	35W	IP67	min 1 - max 8

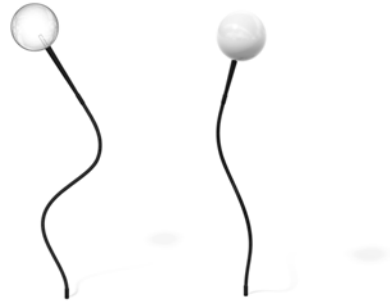
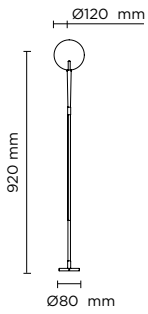

PRODUCT WEIGHT 0,90 kg



Flexa Sphera Big 800

Code Example

905005.**.27**.**.DF**.**.07**.**.0**

Accessories p. 411

Outdoor lighting solution designed to guide and enhance exterior spaces with refined illumination. Featuring a minimalist flexible stainless-steel bollard structure and a distinctive glass element that softens and diffuses the emitted light. All structural parts are phospho-chromatised and polyester powder coated. Total height 920 mm. Remote constant voltage 24V DC power supply needed. IP66 rating.



905005
3W
Transparent Glass

CCT	Beam Angle	lm	lm/w
.27 2700°K	.DF diffused	110	36.60
.30 3000°K	.DF diffused	120	40.00
.40 4000°K	.DF diffused	140	46.60

Finish: **.07** Obsidian Black
Dimming: **.0** ON/OFF



905006
3W
Opal Glass

CCT	Beam Angle	lm	lm/w
.27 2700°K	.DF diffused	110	36.60
.30 3000°K	.DF diffused	120	40.00
.40 4000°K	.DF diffused	140	46.60

Finish: **.07** Obsidian Black
Dimming: **.0** ON/OFF

Remote Driver Selection

Brand	Manufacturer code	Type	Watt	IP Rate	Number of fixtures
Meanwell	LPV-20-24	Contant voltage 24V DC	20W	IP67	min 1 - max 4
Meanwell	LPV-35-24	Contant voltage 24V DC	35W	IP67	min 1 - max 8



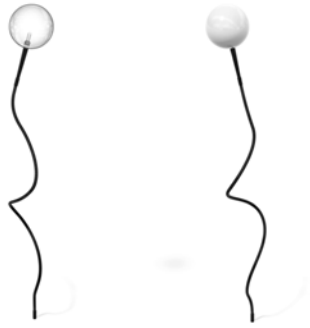
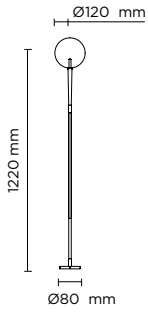

PRODUCT WEIGHT 1,10 kg



Flexa Sphera Big 1100

Code Example

905007.27.DF.07.0

Accessories p. 411

Outdoor lighting solution designed to guide and enhance exterior spaces with refined illumination. Featuring a minimalist flexible stainless-steel bollard structure and a distinctive glass element that softens and diffuses the emitted light. All structural parts are phospho-chromatised and polyester powder coated. Total height 1220 mm. Remote constant voltage 24V DC power supply needed. IP66 rating.



905007
3W
Transparent Glass

CCT	Beam Angle	lm	lm/w
.27 2700°K	.DF diffused	110	36.60
.30 3000°K	.DF diffused	120	40.00
.40 4000°K	.DF diffused	140	46.60

Finish: **.07** Obsidian Black
Dimming: **.0** ON/OFF



905008
3W
Opal Glass

CCT	Beam Angle	lm	lm/w
.27 2700°K	.DF diffused	110	36.60
.30 3000°K	.DF diffused	120	40.00
.40 4000°K	.DF diffused	140	46.60

Finish: **.07** Obsidian Black
Dimming: **.0** ON/OFF

Remote Driver Selection

Brand	Manufacturer code	Type	Watt	IP Rate	Number of fixtures
Meanwell	LPV-20-24	Contant voltage 24V DC	20W	IP67	min 1 - max 4
Meanwell	LPV-35-24	Contant voltage 24V DC	35W	IP67	min 1 - max 8

ACCESSORIES NOT INCLUDED

Accessories to be ordered separately.



AC146

SPIKE

Stainless steel ground spike.

Compatible for all products of the series.



Flexa Filis

Nava + Arosio

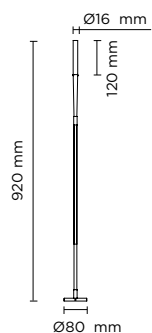

PRODUCT WEIGHT 0,90 kg



Code Example

906001 .27 .DF .07 0

Accessories p. 413

Flexa Filis 800

Outdoor lighting solution designed to guide and enhance exterior spaces with refined illumination. Featuring a minimalist flexible stainless-steel bollard structure and a distinctive glass element that softens and diffuses the emitted light. All structural parts are phospho-chromatised and polyester powder coated. Total height 920 mm. Remote constant voltage 24V DC power supply needed. IP66 rating.



906001
3W
Transparent Glass

CCT	Beam Angle	lm	lm/w
.27 2700°K	.DF diffused	110	36.60
.30 3000°K	.DF diffused	120	40.00
.40 4000°K	.DF diffused	140	46.60

Finish: **.07** Obsidian Black
Dimming: **.0** ON/OFF



906002
3W
Opal Glass

CCT	Beam Angle	lm	lm/w
.27 2700°K	.DF diffused	110	36.60
.30 3000°K	.DF diffused	120	40.00
.40 4000°K	.DF diffused	140	46.60

Finish: **.07** Obsidian Black
Dimming: **.0** ON/OFF

Remote Driver Selection

Brand	Manufacturer code	Type	Watt	IP Rate	Number of fixtures
Meanwell	LPV-20-24	Contant voltage 24V DC	20W	IP67	min 1 - max 4
Meanwell	LPV-35-24	Contant voltage 24V DC	35W	IP67	min 1 - max 8

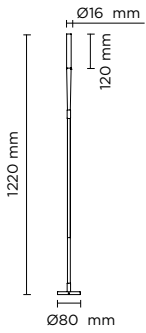

PRODUCT WEIGHT 1,10 kg



Flexa Filis 1100

Outdoor lighting solution designed to guide and enhance exterior spaces with refined illumination. Featuring a minimalist flexible stainless-steel bollard structure and a distinctive glass element that softens and diffuses the emitted light. All structural parts are phospho-chromatised and polyester powder coated. Total height 1220 mm. Remote constant voltage 24V DC power supply needed. IP66 rating.

Code Example

906003.**.27**.**.DF**.**.07**.**.0**

Accessories p. 413

CCT	Beam Angle	lm	lm/w	Finish	Dimming
.27 2700°K	.DF diffused	110	36.60	.07 Obsidian Black	.0 ON/OFF
.30 3000°K	.DF diffused	120	40.00		
.40 4000°K	.DF diffused	140	46.60		



906003
3W
Transparent Glass

CCT	Beam Angle	lm	lm/w	Finish	Dimming
.27 2700°K	.DF diffused	110	36.60	.07 Obsidian Black	.0 ON/OFF
.30 3000°K	.DF diffused	120	40.00		
.40 4000°K	.DF diffused	140	46.60		



906004
3W
Opal Glass

Remote Driver Selection

Brand	Manufacturer code	Type	Watt	IP Rate	Number of fixtures
Meanwell	LPV-20-24	Contant voltage 24V DC	20W	IP67	min 1 - max 4
Meanwell	LPV-35-24	Contant voltage 24V DC	35W	IP67	min 1 - max 8

ACCESSORIES NOT INCLUDED

Accessories to be ordered separately.



AC146

SPIKE

Stainless steel ground spike.

Compatible for all products of the series.



Flexa Dot

Nava + Arosio

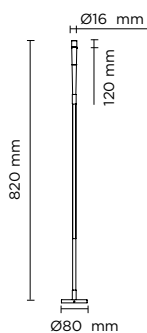

PRODUCT WEIGHT 0,80 kg



Code Example

907001.27.DF.07.0

Accessories p. 415

Flexa Dot 800

Outdoor lighting solution designed to guide and enhance exterior spaces with refined illumination. Featuring a minimalist flexible stainless-steel bollard structure and a distinctive glass element that softens and diffuses the emitted light. All structural parts are phospho-chromatised and polyester powder coated. Total height 820 mm. Remote constant voltage 24V DC power supply needed. IP66 rating



907001
3W
Transparent Glass

CCT	Beam Angle	lm	lm/w
.27 2700°K	.DF diffused	110	36.60
.30 3000°K	.DF diffused	120	40.00
.40 4000°K	.DF diffused	140	46.60

Finish: .07 Obsidian Black
Dimming: .0 ON/OFF



907002
3W
Opal Glass

CCT	Beam Angle	lm	lm/w
.27 2700°K	.DF diffused	110	36.60
.30 3000°K	.DF diffused	120	40.00
.40 4000°K	.DF diffused	140	46.60

Finish: .07 Obsidian Black
Dimming: .0 ON/OFF

Remote Driver Selection

Brand	Manufacturer code	Type	Watt	IP Rate	Number of fixtures
Meanwell	LPV-20-24	Contant voltage 24V DC	20W	IP67	min 1 - max 4
Meanwell	LPV-35-24	Contant voltage 24V DC	35W	IP67	min 1 - max 8

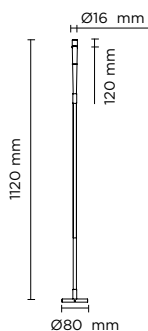

PRODUCT WEIGHT 1,00 kg



Code Example

907003.27.DF.07.0

Accessories p. 415

Flexa Dot 1100

Outdoor lighting solution designed to guide and enhance exterior spaces with refined illumination. Featuring a minimalist flexible stainless-steel bollard structure and a distinctive glass element that softens and diffuses the emitted light. All structural parts are phospho-chromatised and polyester powder coated. Total height 1120 mm. Remote constant voltage 24V DC power supply needed. IP66 rating.



907003
3W
Transparent Glass

CCT	Beam Angle	Im	Im/w
.27 2700°K	.DF diffused	110	36.60
.30 3000°K	.DF diffused	120	40.00
.40 4000°K	.DF diffused	140	46.60

Finish: **.07** Obsidian Black
Dimming: **.0** ON/OFF



907004
3W
Opal Glass

CCT	Beam Angle	Im	Im/w
.27 2700°K	.DF diffused	110	36.60
.30 3000°K	.DF diffused	120	40.00
.40 4000°K	.DF diffused	140	46.60

Finish: **.07** Obsidian Black
Dimming: **.0** ON/OFF

Remote Driver Selection

Brand	Manufacturer code	Type	Watt	IP Rate	Number of fixtures
Meanwell	LPV-20-24	Contant voltage 24V DC	20W	IP67	min 1 - max 4
Meanwell	LPV-35-24	Contant voltage 24V DC	35W	IP67	min 1 - max 8

ACCESSORIES NOT INCLUDED

Accessories to be ordered separately.



AC146

SPIKE

Stainless steel ground spike.

Compatible for all products of the series.



Rondis

Nava + Arosio

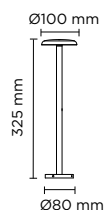

PRODUCT WEIGHT 1,50 kg



Code Example

908001.27.AL.07.0

Accessories p. 421

Rondis Rounded 300

Outdoor lighting solution designed to guide and enhance exterior spaces with refined illumination. Featuring a minimalist stainless-steel bollard structure and light head. All structural parts are phospho-chromatised and polyester powder coated. Total height 325 mm. Remote constant voltage 24V DC power supply needed. IP66 rating.



908001
9W

CCT	Beam Angle	lm	lm/w	Finish	Dimming
.27 2700°K	.AL 360°	450	50.00	.07 Obsidian Black	.0 ON/OFF
.30 3000°K	.AL 360°	465	51.66	.08 Wild Green	
.40 4000°K	.AL 360°	480	53.33	.09 Dark Brown	

Remote Driver Selection

Brand	Manufacturer code	Type	Watt	IP Rate	Number of fixtures
Meanwell	LPV-20-24	Contant voltage 24V DC	20W	IP67	1
Meanwell	LPV-35-24	Contant voltage 24V DC	35W	IP67	min 1 - max 2

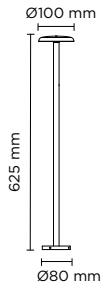

PRODUCT WEIGHT 1,70 kg



Rondis Rounded 600

Outdoor lighting solution designed to guide and enhance exterior spaces with refined illumination. Featuring a minimalist stainless-steel bollard structure and light head. All structural parts are phospho-chromatised and polyester powder coated. Total height 625 mm. Remote constant voltage 24V DC power supply needed. IP66 rating.

Code Example

908002.27.AL.07.0

Accessories p. 421



908002
9W

CCT	Beam Angle	lm	lm/w	Finish	Dimming
.27 2700°K	.AL 360°	450	50.00	.07 Obsidian Black	.0 ON/OFF
.30 3000°K	.AL 360°	465	51.66	.08 Wild Green	
.40 4000°K	.AL 360°	480	53.33	.09 Dark Brown	

Remote Driver Selection

Brand	Manufacturer code	Type	Watt	IP Rate	Number of fixtures
Meanwell	LPV-20-24	Contant voltage 24V DC	20W	IP67	1
Meanwell	LPV-35-24	Contant voltage 24V DC	35W	IP67	min 1 - max 2

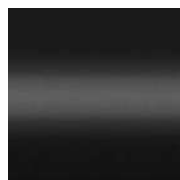

Obsidian Black



Wild Green



Dark Brown

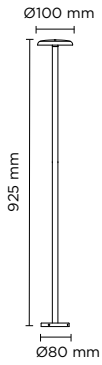

PRODUCT WEIGHT 1,90 kg



Code Example

908003.**.27**.**.AL**.**.07**.**.0**

Accessories p. 421

Rondis Rounded 900

Outdoor lighting solution designed to guide and enhance exterior spaces with refined illumination. Featuring a minimalist stainless-steel bollard structure and light head. All structural parts are phospho-chromatised and polyester powder coated. Total height 925 mm. Remote constant voltage 24V DC power supply needed. IP66 rating.



908003
9W

CCT	Beam Angle	lm	lm/w	Finish	Dimming
.27 2700°K	.AL 360°	450	50.00	.07 Obsidian Black	.0 ON/OFF
.30 3000°K	.AL 360°	465	51.66	.08 Wild Green	
.40 4000°K	.AL 360°	480	53.33	.09 Dark Brown	

Remote Driver Selection

Brand	Manufacturer code	Type	Watt	IP Rate	Number of fixtures
Meanwell	LPV-20-24	Contant voltage 24V DC	20W	IP67	1
Meanwell	LPV-35-24	Contant voltage 24V DC	35W	IP67	min 1 - max 2



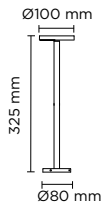

PRODUCT WEIGHT 1,50 kg



Code Example

908004.27.AL.07.0

Accessories p. 421

Rondis Flat 300

Outdoor lighting solution designed to guide and enhance exterior spaces with refined illumination. Featuring a minimalist stainless-steel bollard structure and light head. All structural parts are phospho-chromatised and polyester powder coated. Total height 325 mm. Remote constant voltage 24V DC power supply needed. IP66 rating.



908004
9W

CCT	Beam Angle	lm	lm/w	Finish	Dimming
.27 2700°K	.AL 360°	450	50.00	.07 Obsidian Black	.0 ON/OFF
.30 3000°K	.AL 360°	465	51.66	.08 Wild Green	
.40 4000°K	.AL 360°	480	53.33	.09 Dark Brown	

Remote Driver Selection

Brand	Manufacturer code	Type	Watt	IP Rate	Number of fixtures
Meanwell	LPV-20-24	Contant voltage 24V DC	20W	IP67	1
Meanwell	LPV-35-24	Contant voltage 24V DC	35W	IP67	min 1 - max 2

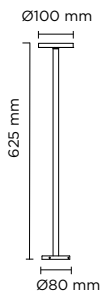

PRODUCT WEIGHT 1,70 kg



Code Example

908005.27.AL.07.0

Accessories p. 421

Rondis Flat 600

Outdoor lighting solution designed to guide and enhance exterior spaces with refined illumination. Featuring a minimalist stainless-steel bollard structure and light head. All structural parts are phospho-chromatised and polyester powder coated. Total height 625 mm. Remote constant voltage 24V DC power supply needed. IP66 rating.



908005
9W

CCT	Beam Angle	lm	lm/w	Finish	Dimming
.27 2700°K	.AL 360°	450	50.00	.07 Obsidian Black	.0 ON/OFF
.30 3000°K	.AL 360°	465	51.66	.08 Wild Green	
.40 4000°K	.AL 360°	480	53.33	.09 Dark Brown	

Remote Driver Selection

Brand	Manufacturer code	Type	Watt	IP Rate	Number of fixtures
Meanwell	LPV-20-24	Contant voltage 24V DC	20W	IP67	1
Meanwell	LPV-35-24	Contant voltage 24V DC	35W	IP67	min 1 - max 2



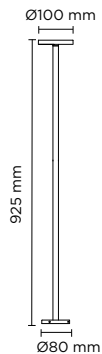

PRODUCT WEIGHT 1,90 kg



Rondis Flat 900

Code Example

908006.27.AL.07.0

Accessories p. 421

Outdoor lighting solution designed to guide and enhance exterior spaces with refined illumination. Featuring a minimalist stainless-steel bollard structure and light head. All structural parts are phospho-chromatised and polyester powder coated. Total height 925 mm. Remote constant voltage 24V DC power supply needed. IP66 rating.



908006

9W

CCT	Beam Angle	Im	Im/w	Finish	Dimming
.27 2700°K	.AL 360°	450	50.00	.07 Obsidian Black	.0 ON/OFF
.30 3000°K	.AL 360°	465	51.66	.08 Wild Green	
.40 4000°K	.AL 360°	480	53.33	.09 Dark Brown	

Remote Driver Selection

Brand	Manufacturer code	Type	Watt	IP Rate	Number of fixtures
Meanwell	LPV-20-24	Contant voltage 24V DC	20W	IP67	1
Meanwell	LPV-35-24	Contant voltage 24V DC	35W	IP67	min 1 - max 2

INTEGRATED ACCESSORIES

908001.27.AL.07.0

Built-in accessories to be requested when ordering example 908001.27.AL.01.0.**CD**



.CD

COLORED DISC

Colored PMMA disc designed to be combined with Rondis glass diffuser. It becomes luminescent, adding a distinctive aesthetic accent.

ACCESSORIES NOT INCLUDED

Accessories to be ordered separately.



AC146

SPIKE

Stainless steel ground spike. **Compatible for all products of the series.**



Lucea

Nava + Arosio

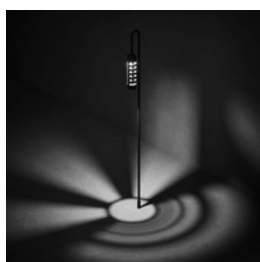
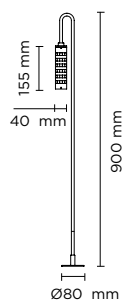

Empty cage version

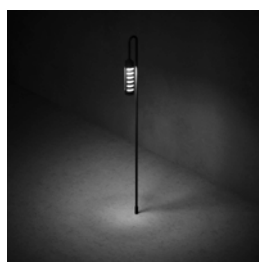

Opal glass diffuser

PRODUCT WEIGHT:
909001: 1,50 /kg
909002: 1,60 /kg



Code Example

909001, .27, .DF, .07, 0

Accessories p. 427

Lucea Petit

Outdoor lighting solution designed to guide and enhance exterior spaces with refined illumination. Featuring a minimalist stainless-steel bollard structure and light head. All structural parts are phospho-chromatised and polyester powder coated. Total height 900 mm. Remote constant voltage 24V DC power supply needed. IP66 rating.



909001
3W
 Empty cage

CCT	Beam Angle	Im	Im/w
.27 2700°K	.DF Diffused	110	36.60
.30 3000°K	.DF Diffused	120	40.00
.40 4000°K	.DF Diffused	140	46.60

Finish	Dimming
.07 Obsidian Black	.0 ON/OFF
.08 Wild Green	
.09 Dark Brown	



909002
3W
 Cage with opal glass diffuser

CCT	Beam Angle	Im	Im/w
.27 2700°K	.DF Diffused	110	36.60
.30 3000°K	.DF Diffused	120	40.00
.40 4000°K	.DF Diffused	140	46.60

Finish	Dimming
.07 Obsidian Black	.0 ON/OFF
.08 Wild Green	
.09 Dark Brown	

PRODUCT WEIGHT 1,60 kg

Remote Driver Selection

Brand	Manufacturer code	Type	Watt	IP Rate	Number of fixtures
Meanwell	LPV-20-24	Contant voltage 24V DC	20W	IP67	min 1 - max 4
Meanwell	LPV-35-24	Contant voltage 24V DC	35W	IP67	min 1 - max 8

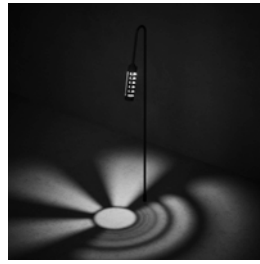
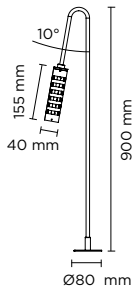

Empty cage version



Opal glass diffuser

PRODUCT WEIGHT:
909003: 1,50 /kg
909004: 1,60 /kg



Lucea Petit 10°

Outdoor lighting solution designed to guide and enhance exterior spaces with refined illumination. Featuring a minimalist stainless-steel bollard structure and light head. All structural parts are phospho-chromatised and polyester powder coated. Total height 900 mm. Remote constant voltage 24V DC power supply needed. IP66 rating.

Code Example

909003.27.DF.07.0

Accessories p. 427



909003
 Empty cage

CCT	Beam Angle	Im	Im/w
.27 2700°K	.DF Diffused	110	36.60
.30 3000°K	.DF Diffused	120	40.00
.40 4000°K	.DF Diffused	140	46.60

Finish	Dimming
.07 Obsidian Black	.0 ON/OFF
.08 Wild Green	
.09 Dark Brown	



909004
 3W
 Cage with opal glass diffuser

CCT	Beam Angle	Im	Im/w
.27 2700°K	.DF Diffused	110	36.60
.30 3000°K	.DF Diffused	120	40.00
.40 4000°K	.DF Diffused	140	46.60

Finish	Dimming
.07 Obsidian Black	.0 ON/OFF
.08 Wild Green	
.09 Dark Brown	

Remote Driver Selection

Brand	Manufacturer code	Type	Watt	IP Rate	Number of fixtures
Meanwell	LPV-20-24	Contant voltage 24V DC	20W	IP67	min 1 - max 4
Meanwell	LPV-35-24	Contant voltage 24V DC	35W	IP67	min 1 - max 8



Obsidian Black



Wild Green



Dark Brown

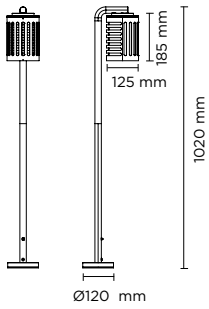

Empty cage version

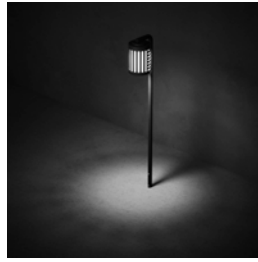

Opal glass diffuser

PRODUCT WEIGHT:
909005: 4,50 /kg
909006: 4,70 /kg



Lucea Bollard

Code Example

909005 . 27 . DF . 07 . 0

Accessories p. 427

Outdoor lighting solution designed to guide and enhance exterior spaces with refined illumination. Featuring a minimalist stainless-steel bollard structure and light head. All structural parts are phospho-chromatised and polyester powder coated. Total height 1020 mm. With 1 direct 220-240V LUMENS “EDC 38C” COB LED IP66 rating.



909005
 8W
 Empty cage

CCT	Beam Angle	Im	Im/w
.27 2700°K	.DF Diffused	440	55.00
.30 3000°K	.DF Diffused	450	56.25
.40 4000°K	.DF Diffused	480	60.00

Finish	Dimming
.07 Obsidian Black	.0 ON/OFF
.08 Wild Green	
.09 Dark Brown	



909006
 8W
 Cage with opal glass diffuser

CCT	Beam Angle	Im	Im/w
.27 2700°K	.DF Diffused	440	55.00
.30 3000°K	.DF Diffused	450	56.25
.40 4000°K	.DF Diffused	480	60.00

Finish	Dimming
.07 Obsidian Black	.0 ON/OFF
.08 Wild Green	
.09 Dark Brown	



Obsidian Black



Wild Green



Dark Brown



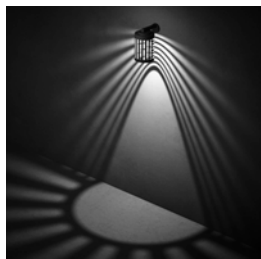
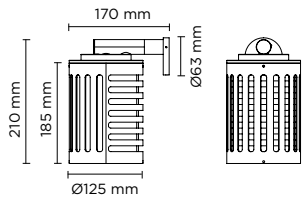

Empty cage version

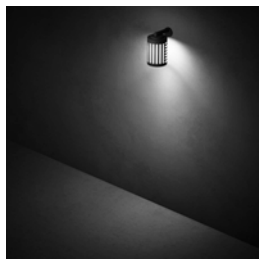

Opal glass diffuser

PRODUCT WEIGHT:
909007: 2,00 /kg
909008: 2,20 /kg



Lucea Wall

This wall-mounted luminaire translates the essential design of Lucea concept into a refined outdoor wall light. Featuring a stainless-steel wall fixing base and light head. All structural parts are phospho-chromatised and polyester powder coated. With 1 direct 220-240V LUMENS "EDC 38C" COB LED IP66 rating.

Code Example

909007.**.27**.**.DF**.**.07**.**.0**

Accessories p. 427



909007
8W
 Empty cage

CCT	Beam Angle	Im	Im/w
.27 2700°K	.DF Diffused	440	55.00
.30 3000°K	.DF Diffused	450	56.25
.40 4000°K	.DF Diffused	480	60.00

Finish	Dimming
.07 Obsidian Black	.0 ON/OFF
.08 Wild Green	
.09 Dark Brown	



909008
8W
 Cage with opal glass diffuser

CCT	Beam Angle	Im	Im/w
.27 2700°K	.DF Diffused	440	55.00
.30 3000°K	.DF Diffused	450	56.25
.40 4000°K	.DF Diffused	480	60.00

Finish	Dimming
.07 Obsidian Black	.0 ON/OFF
.08 Wild Green	
.09 Dark Brown	

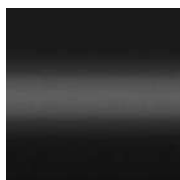

Obsidian Black



Wild Green



Dark Brown

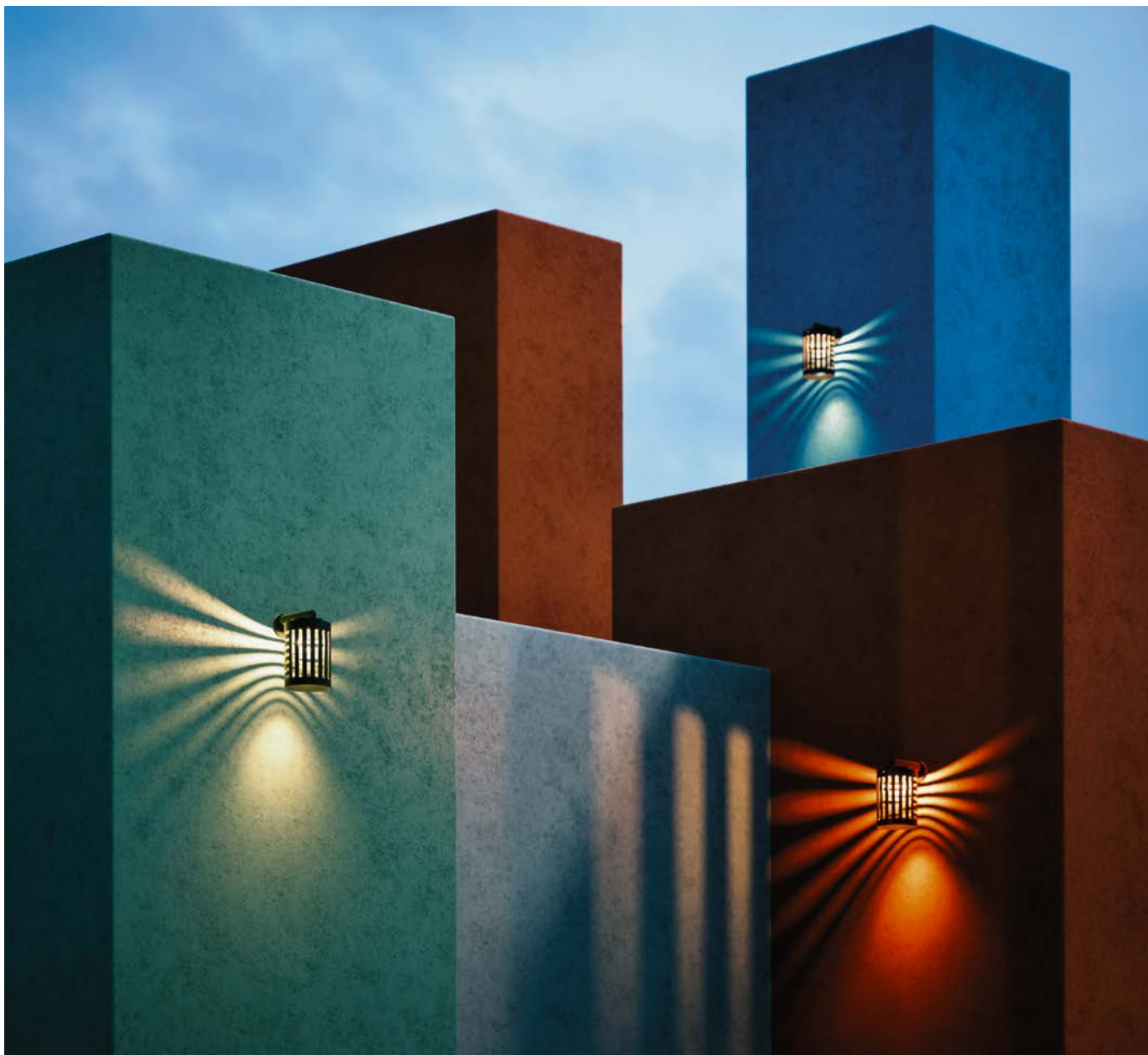

ACCESSORIES NOT INCLUDED

Accessories to be ordered separately.



AC146

SPIKE

Stainless steel ground spike.

Available for:

- ALL LUCEA **PETIT** ITEMS
- ALL LUCEA **BOLLARD** ITEMS



AC065

ANCHORAGE UNIT

Available for:

- ALL LUCEA **BOLLARD** ITEMS

Code to order **AC0079**

Demo box

Sample case including following products:

Tech Evo Mini 02

Hydrofloor Nano

Wave 2.0

Tag Mini 03



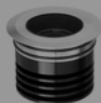



Ring Mini





ELEMENTS TO CONSIDER IN A NEW (OR EXISTING) LIGHTING PROJECT

IP protective degree (IEC 529 & EN 60529 norms)

IP 1...	Protected against the entry of solid bodies with dimensions of more than 50 mm.	IP O...	Unprotected.
IP 2...	Protected against the entry of solid bodies with dimensions of more than 12 mm.	IP ...1	Protected against the vertical falling of water drop.
IP 3...	Protected against the entry of solid bodies with dimensions of more than 2,5 mm.	IP ...2	Protected against the falling of water with a maximum inclination of 15°.
IP 4...	Protected against the entry of solid bodies with dimensions of more than 1 mm.	IP ...3	 Protected against rain.
IP 5...	 Protected against entry of dust.	IP ...4	 Protected against sprinklings.
IP 6...	 Completely protected against entry of dust.	IP ...5	 Protected against water jets.
		IP ...6	Protected against heavy waves.
		IP ...7	 Temporary immersion proof.
		IP ...8	Immersion.

WARNING. Unless otherwise specified articles in this catalogue are not for permanent and continous immersion in water.

Some fittings, although classified and tested IP 68 cannot be installed permanently in water according to international norms IEC364-7-702 (max 12 V A.C. or 30 V D.C. in water).

They can only withstand (resist) accidental immersion of 1,3 m

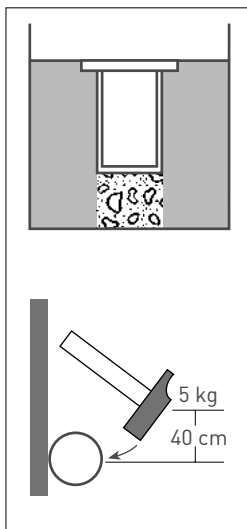

MECHANICAL SHOCK (CEI EN 50102 norms)

Protection of the hardware against the mechanical shocks.

Test: shock resistance from a hammer of 5 kg falling from 0,40 m.

Intensity of shock:
20 Joules = IK 10.

depth due to temporary flooding.

WARNING: in all ground lighting fittings installation, at least a 20 cm depth drain hole filled by gravel must be made to prevent flooding. Use h07rn-f cables only. Other kind of cables may not be conformed to assure the IP 67 or IP 68 rating.

SHOCK RESISTANCE CEI EN 50102

IK01	0,15 J
IK02	0,2 J
IK03	0,35 J
IK04	0,5 J
IK05	0,7 J
IK06	1 J
IK07	2 J
IK08	5 J
IK09	10 J
IK10	20 J

WARNING!

Some chemical substances, liquids or vapour, may cause corrosion/damages on metal parts of the fittings. Verify the presence of these substances when installing the products and the compatibility with such substances. Stainless steel surfaces could be damaged by: Sodium Hydroxide (soda), liquid Chlorine or vapour, Hydrochloric acid, Nitric acid (20%), Sulphuric acid (30%).

Die-cast Aluminium could be damaged by: Arsenic Acid (20%), Acetic acid, Hydrochloric acid, Formic acid, Nitric acid (20%), Sulphuric acid (30%), Quicklime, Sodium Hydroxide (soda). Suggestion: very important is to regularly clean the fitting surfaces. At least once a year or during bulb replacement. Cleaning could be made with diluted soap or detergent. In any case do not use Solvent or Ethylene base products.

WARRANTY TERMS

P.U.K. Italia Group guarantees the performance of its products only and exclusively in relation to how they are used, their destination and application as explicitly specified.

THE WARRANTY OF THE PRODUCTS HAS A 5 YEAR VALIDITY STARTING FROM THE DATE OF DELIVERY TO THE PURCHASER.

Any claims must be forwarded in writing to P.U.K. Italia Group together with a copy of the purchase invoice complete with delivery date, description of the fault and number of products that are faulty.

P.U.K. Italia Group, according to its indisputable choice will arrange either to repair or replace them within a reasonable period of time from the claim. Returned faulty goods will be accepted by P.U.K. Italia Group only if previously authorised in writing, correctly forwarded, suitably packed and with transport prepaid.

This guarantee does not cover further expenses sustained by the Purchaser consequent to the faulty condition of the products; in particular P.U.K. Italia Group will not bear the cost of collecting the faulty products from customers (including cost of dismantling) and forwarding of replacement products to them.

Any responsibility on the part of P.U.K. Italia Group is explicitly excluded in the following cases:

- use, assembly and/or improper or unreasonable maintenance of the products, and/or their correct preservation;
- if damage or bad functioning is caused by work carried out on products without prior written authorisation from P.U.K. Italia Group (e.g. disassembly, alterations, substitutions, etc.);
- if the quality and performance have been compromised by the addition of accessories not approved by P.U.K. Italia Group.

This guarantee includes and replaces every other possible responsibility stemming from the products supplied, no matter how it originated: in particular the Purchaser cannot claim damages, reduction in prices or cancellation of the contract. In no case will P.U.K. Italia Group be responsible for indirect damage or loss of profit.

The Law Court in Monza is the sole competent Court for any disputes.

PUK ITALIA GROUP

Via San Giorgio, 16 | 20851 Lissone (MB) Italy

T. +39 039 2457920 | F. + 39 039 2457924

puk@puk.it

